

robodacta.mx
robótica didáctica

Manual de ensamble
Avioneta Con Liga
Código KIT-1412

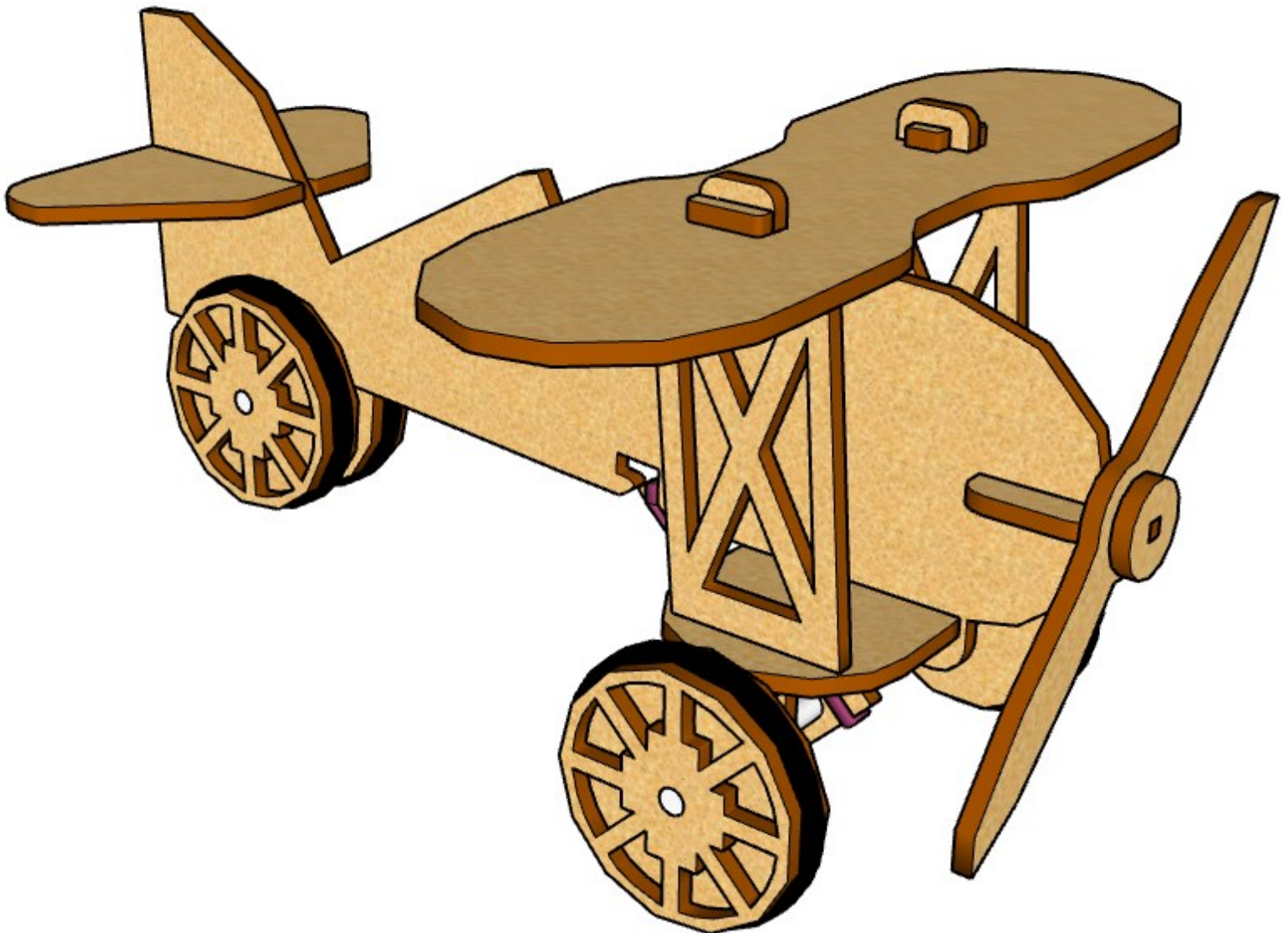

Para poder armar **Negritas** identifica las siguientes piezas.

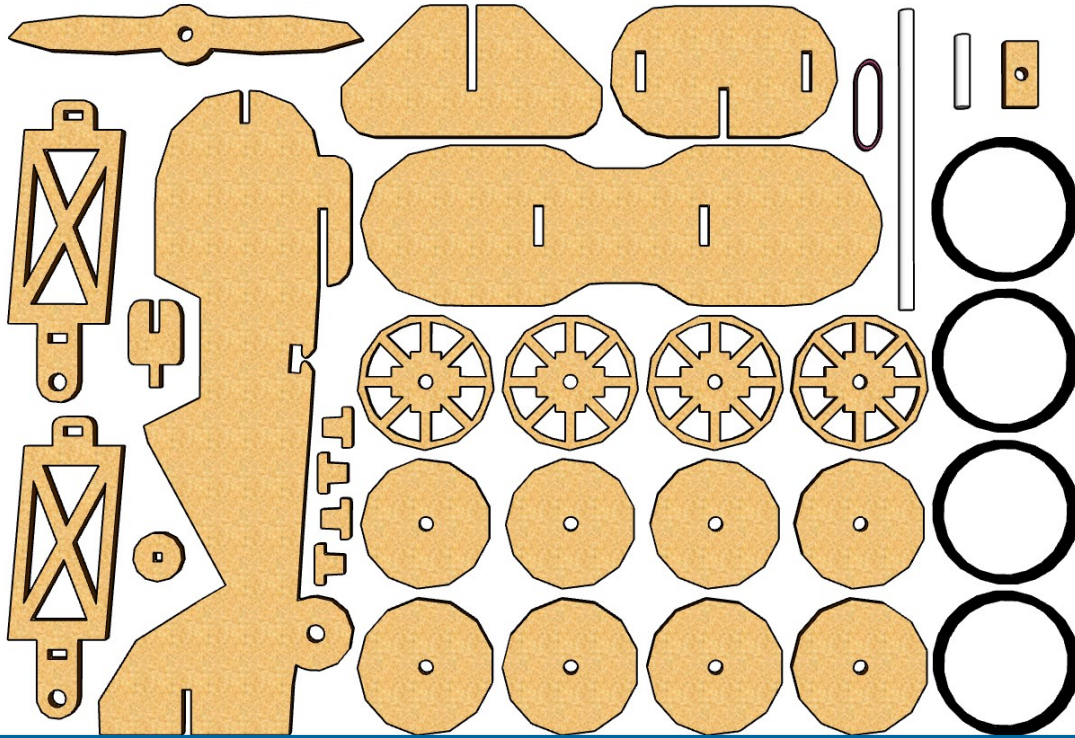

Utiliza pegamento blanco (no incluido) en donde se indica con la siguiente imagen.

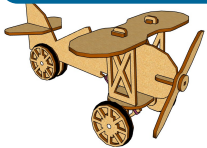

1

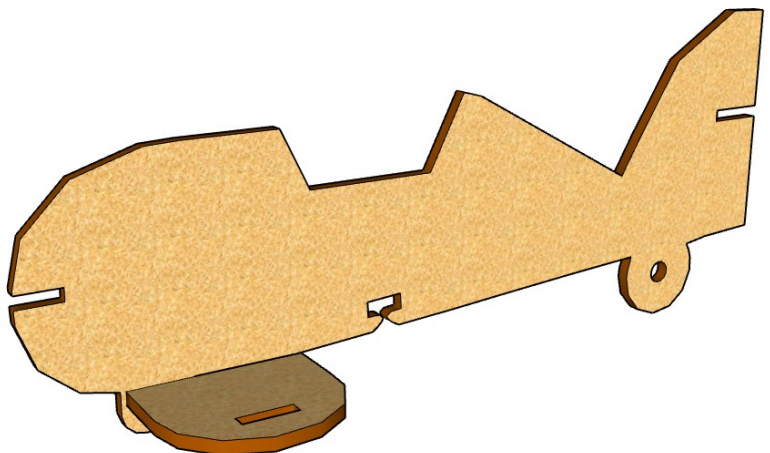
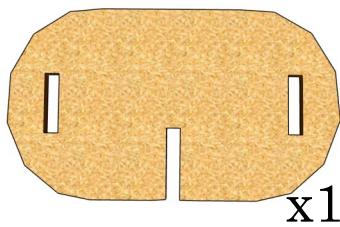
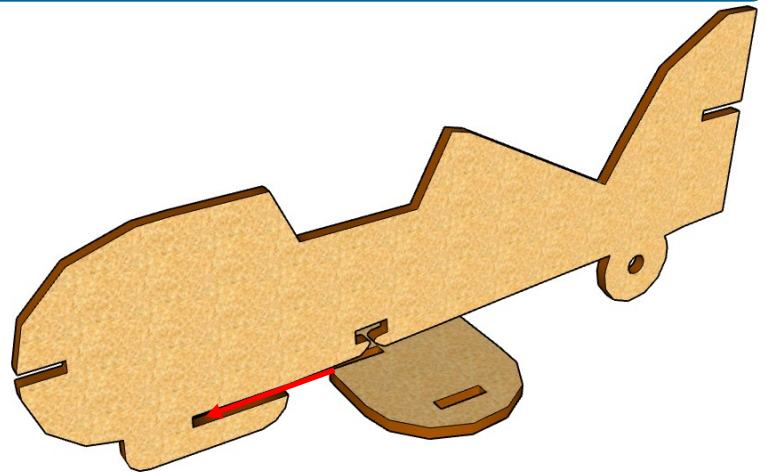
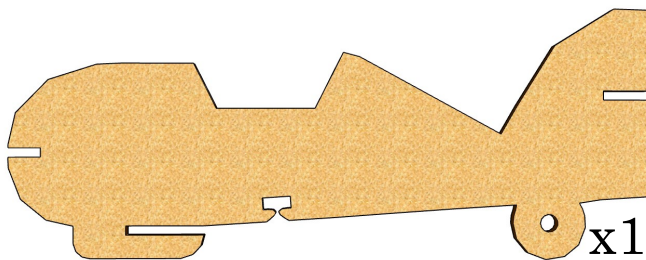

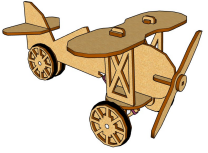

2

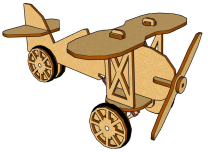
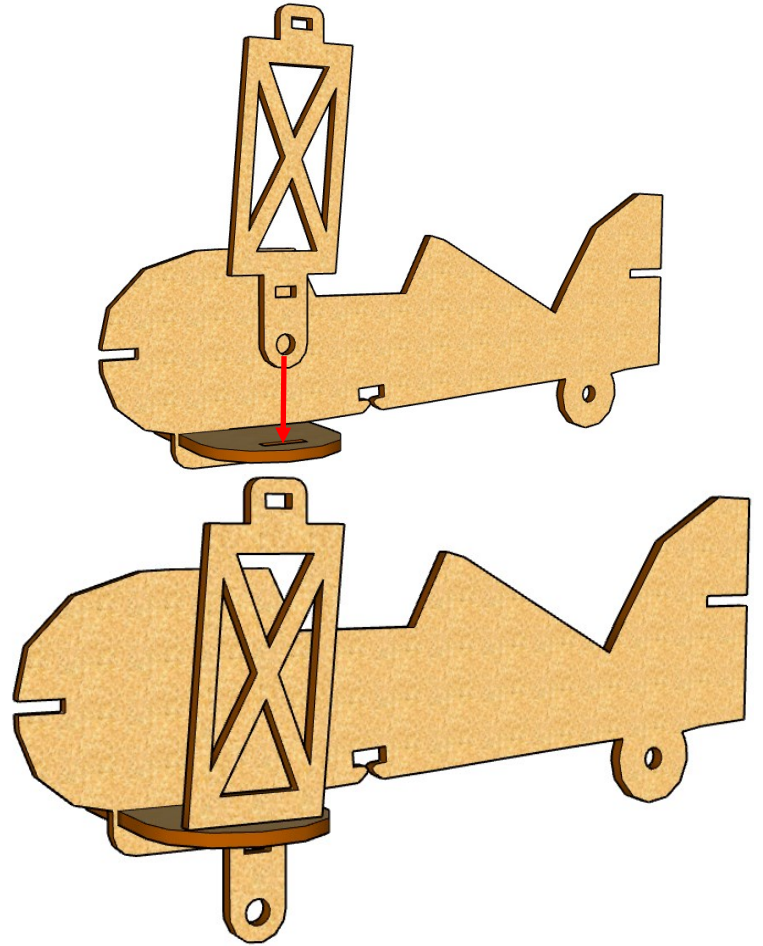
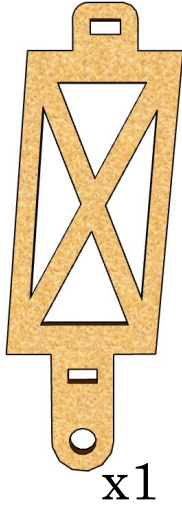

3

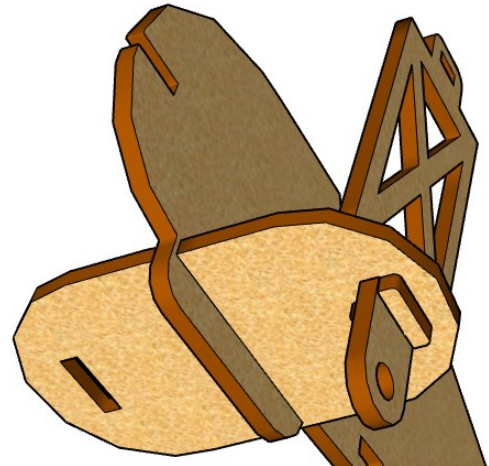
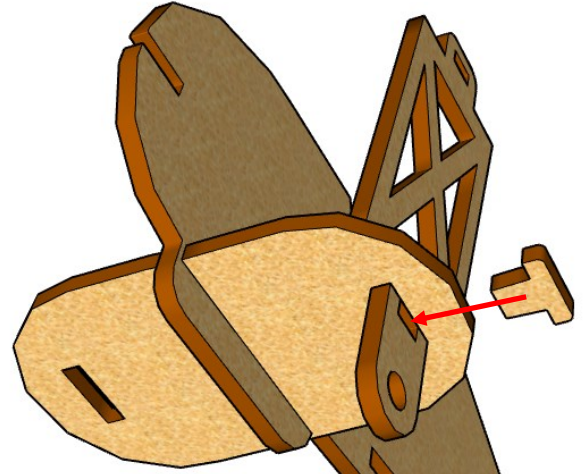
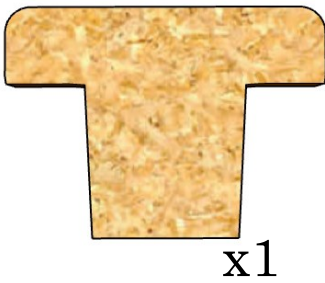

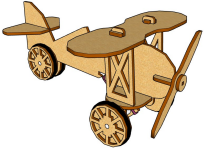

4

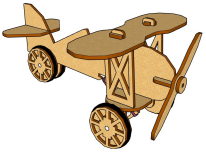
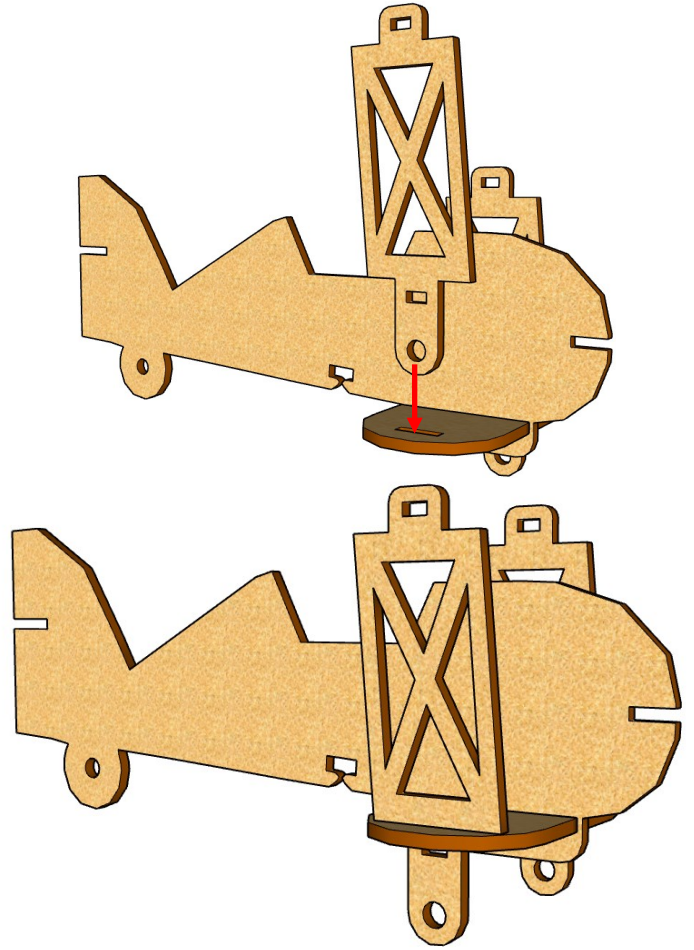
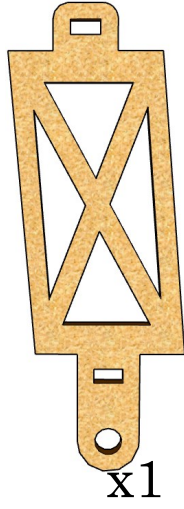

5

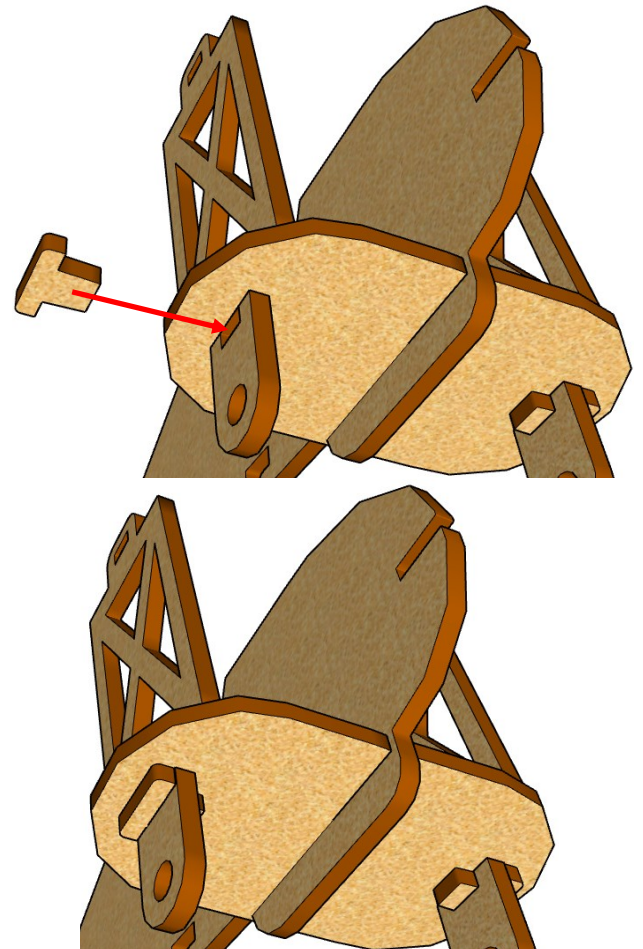
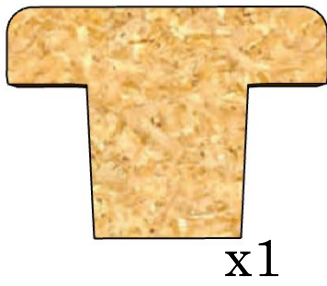

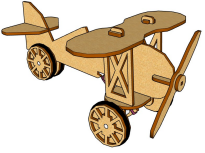

6

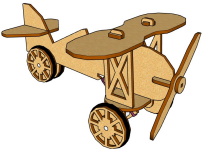
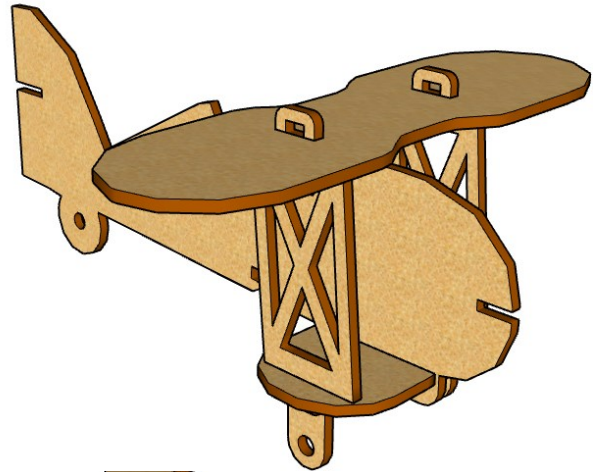
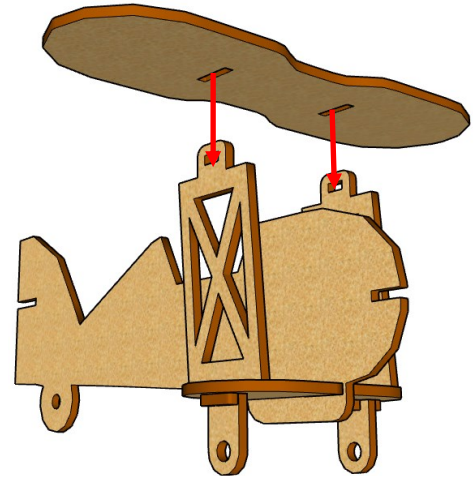
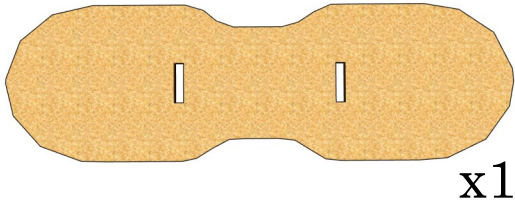

7

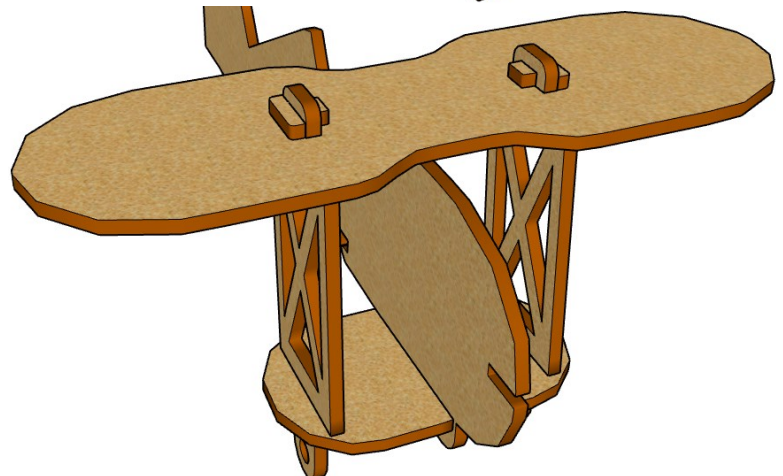
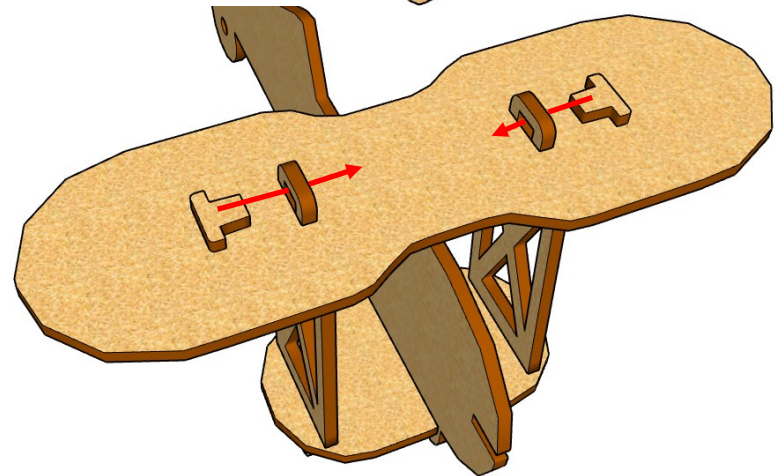
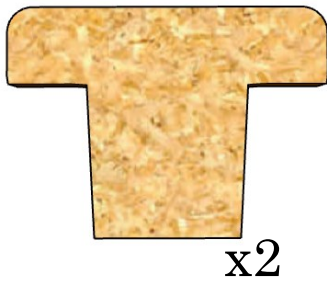

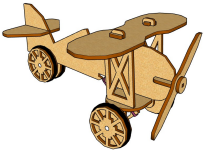

8

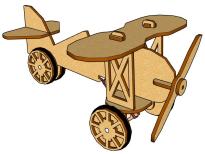
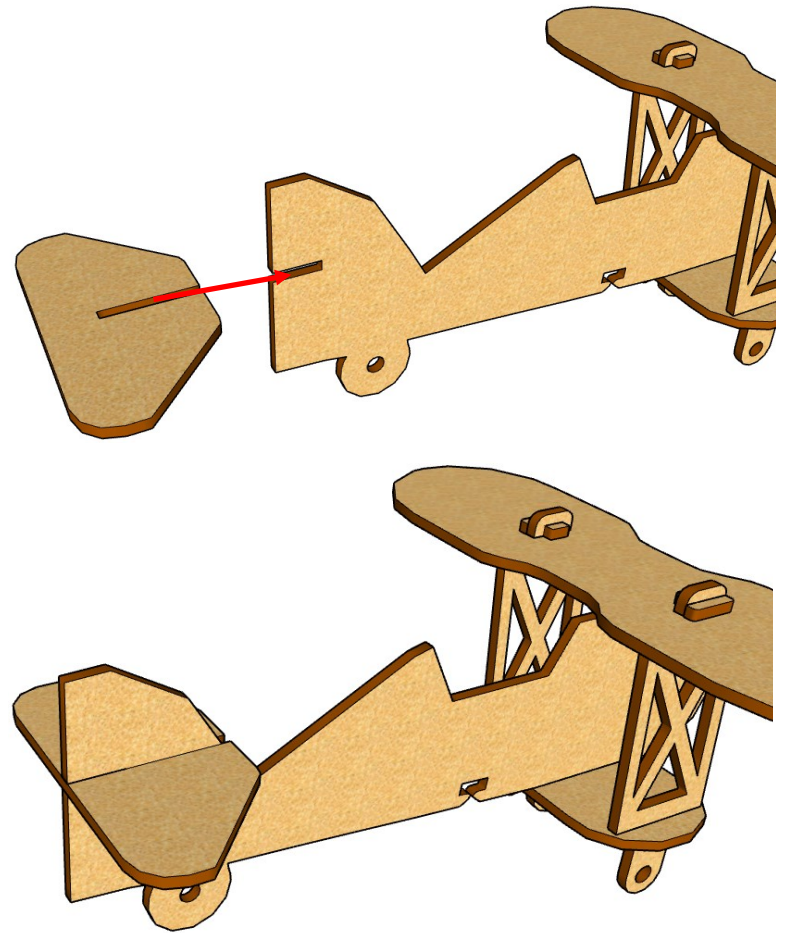
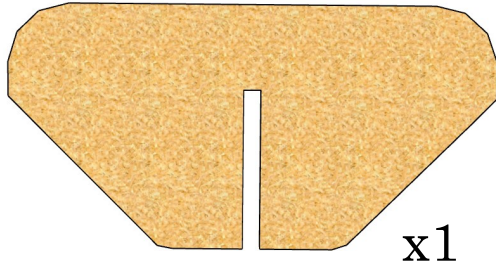

9

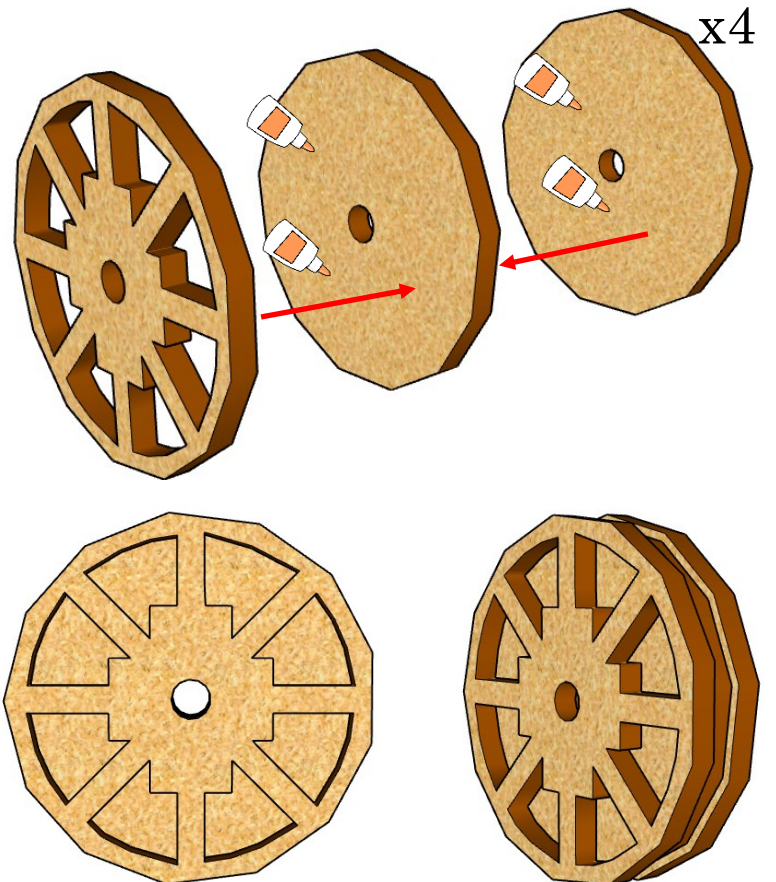
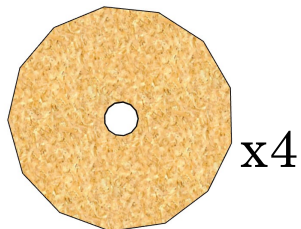
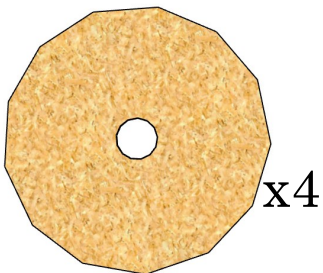
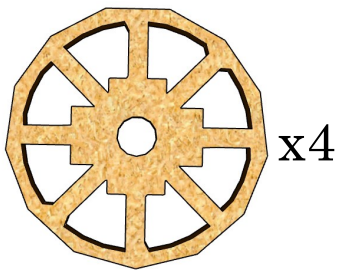

Notas: Una de las ruedas debe ser más pequeña que las demás, colócale en el medio.

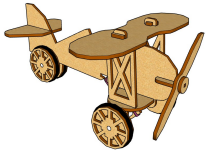

10

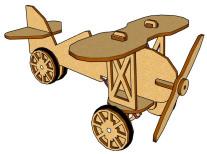
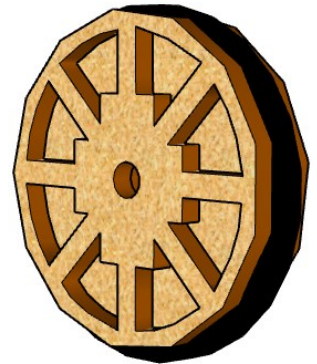
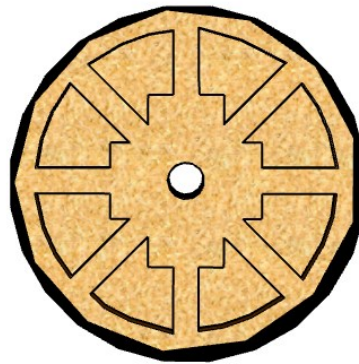
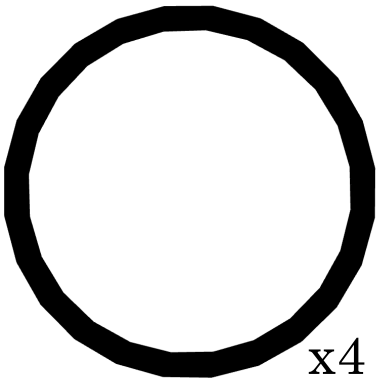
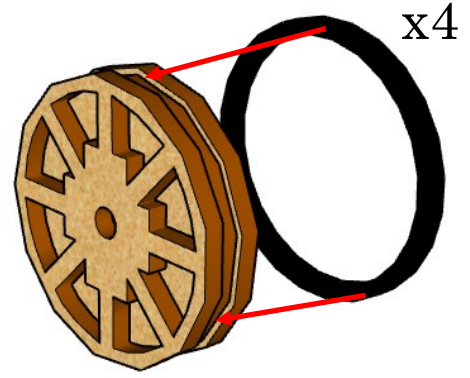
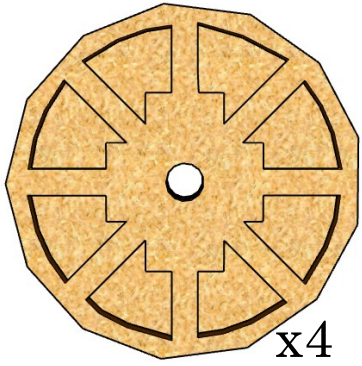

11

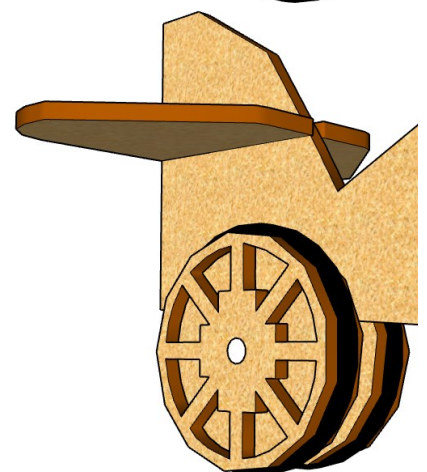
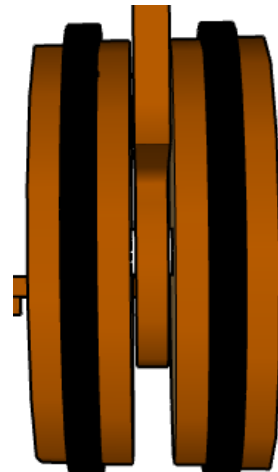
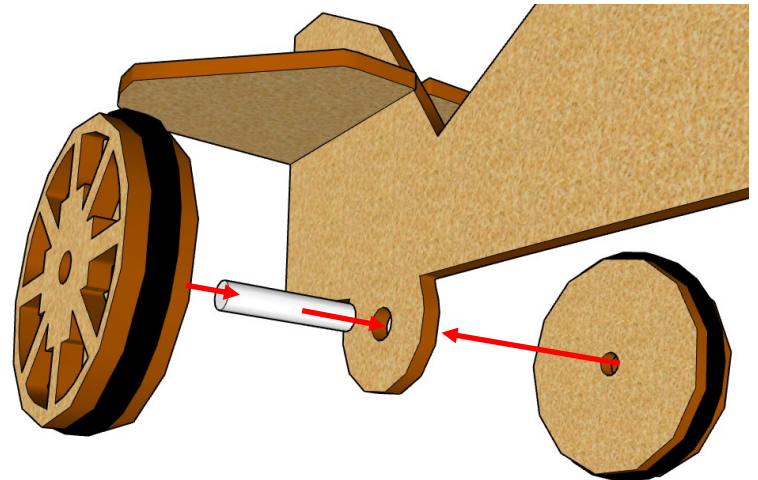
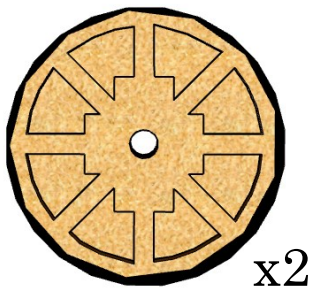

Notas: Las ruedas entran a presión.
Si es necesario colócales pegamento.

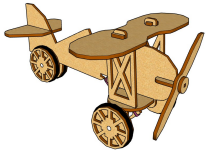

12

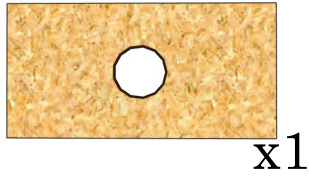

x1

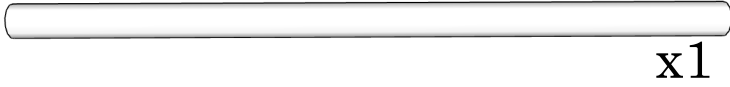

x1

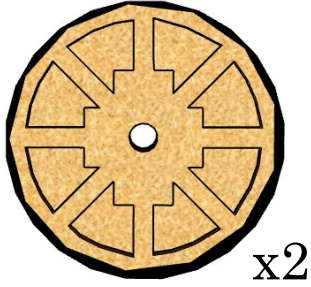

x2

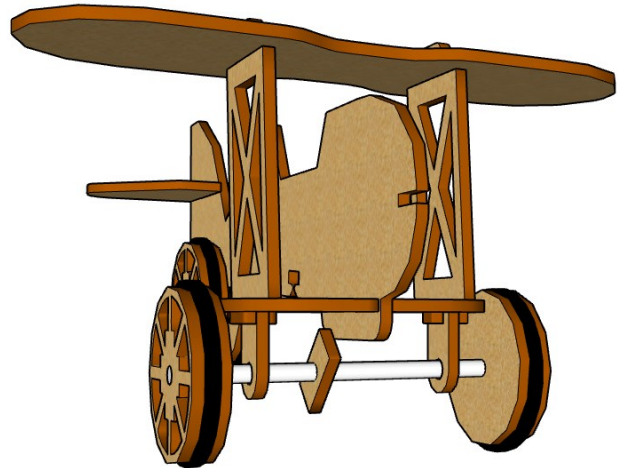
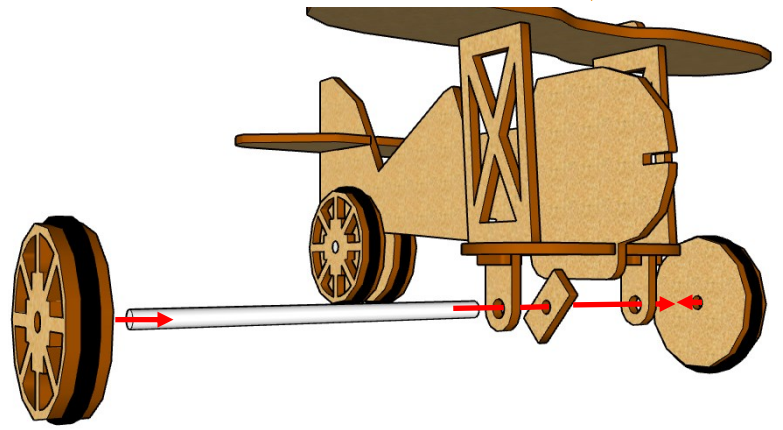

Notas: Las piezas entran a presión.
Si es necesario colócales pegamento.

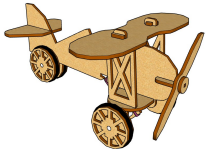

13

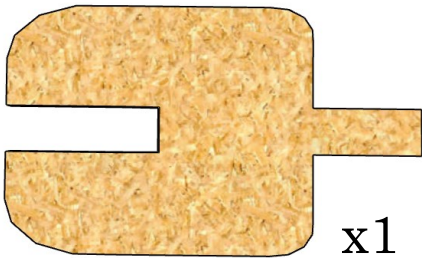

x1

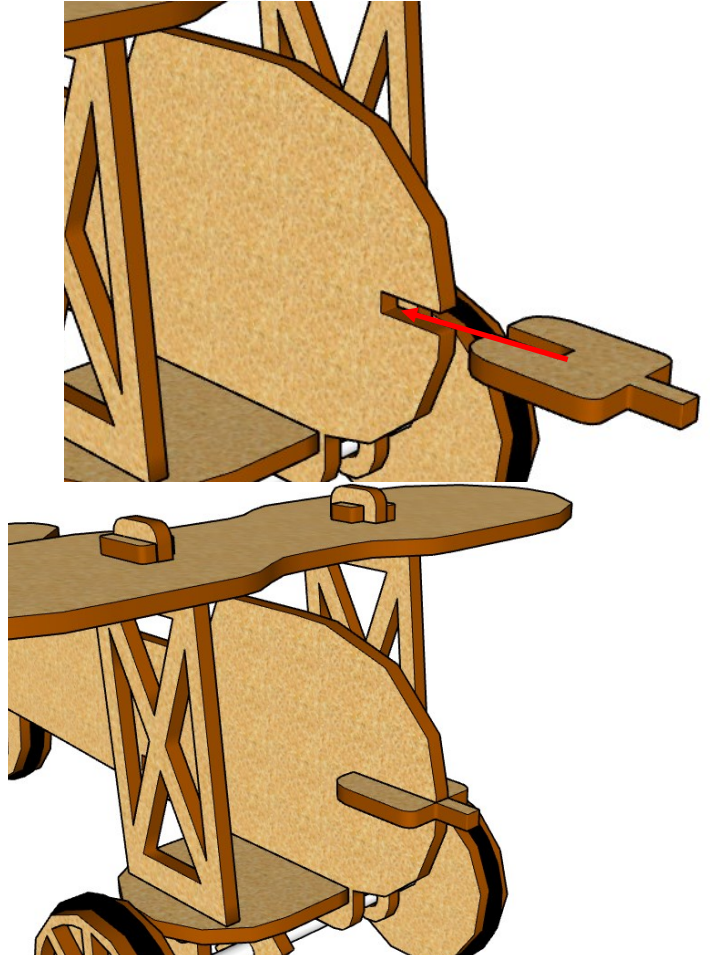

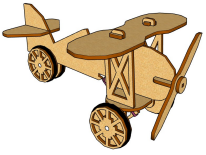

14

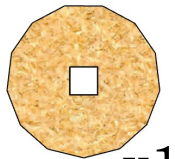
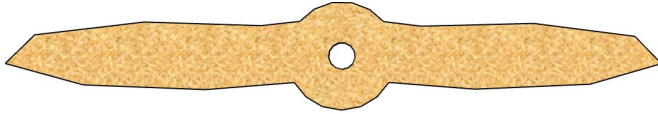

x1

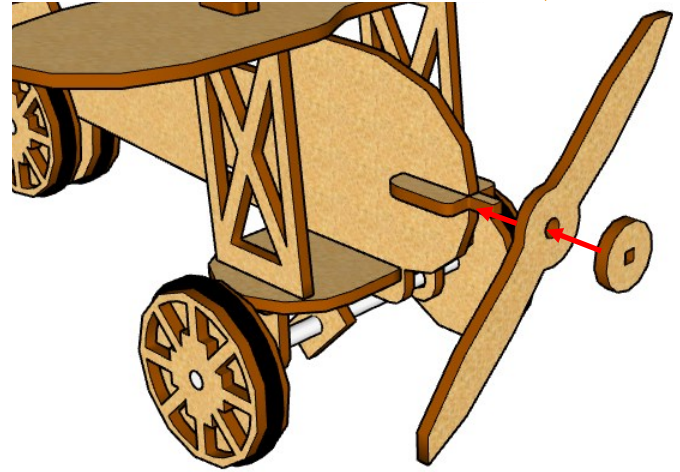

Notas: El circulo entra a presión.

Si es necesario colócale pegamento.

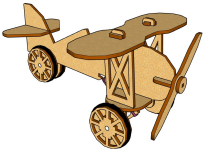

15

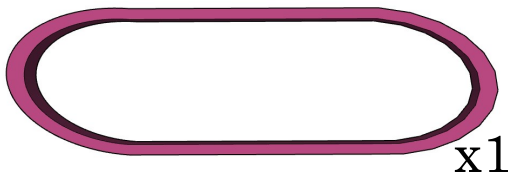

x1

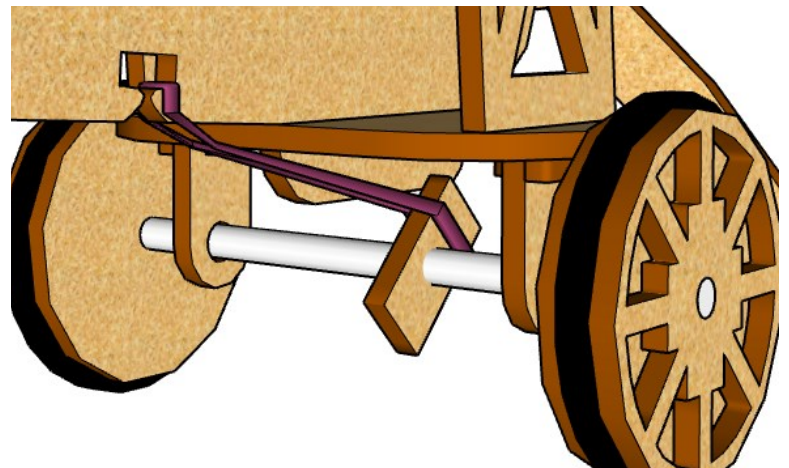
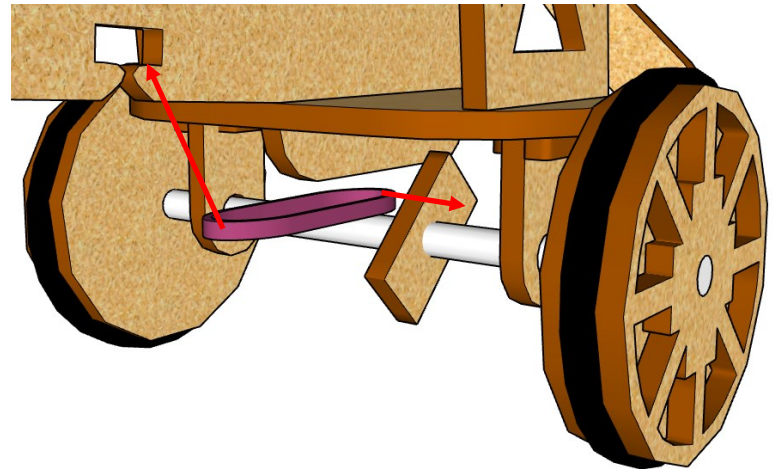

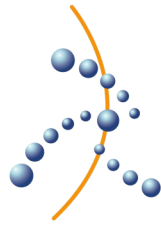

robodacta.mx
robótica didáctica

No te olvides visitar nuestro sitio web y seguirnos en nuestras redes sociales donde encontrarás más contenido.

www.robodacta.mx



@Robodacta.RD



56 28 08 95 23



@robodacta.mx



RobodactaMx