

robodacta.mx
robótica didáctica

Manual de ensamble
Kit Seguidor de Línea Básico V.2
Código KIT-1285

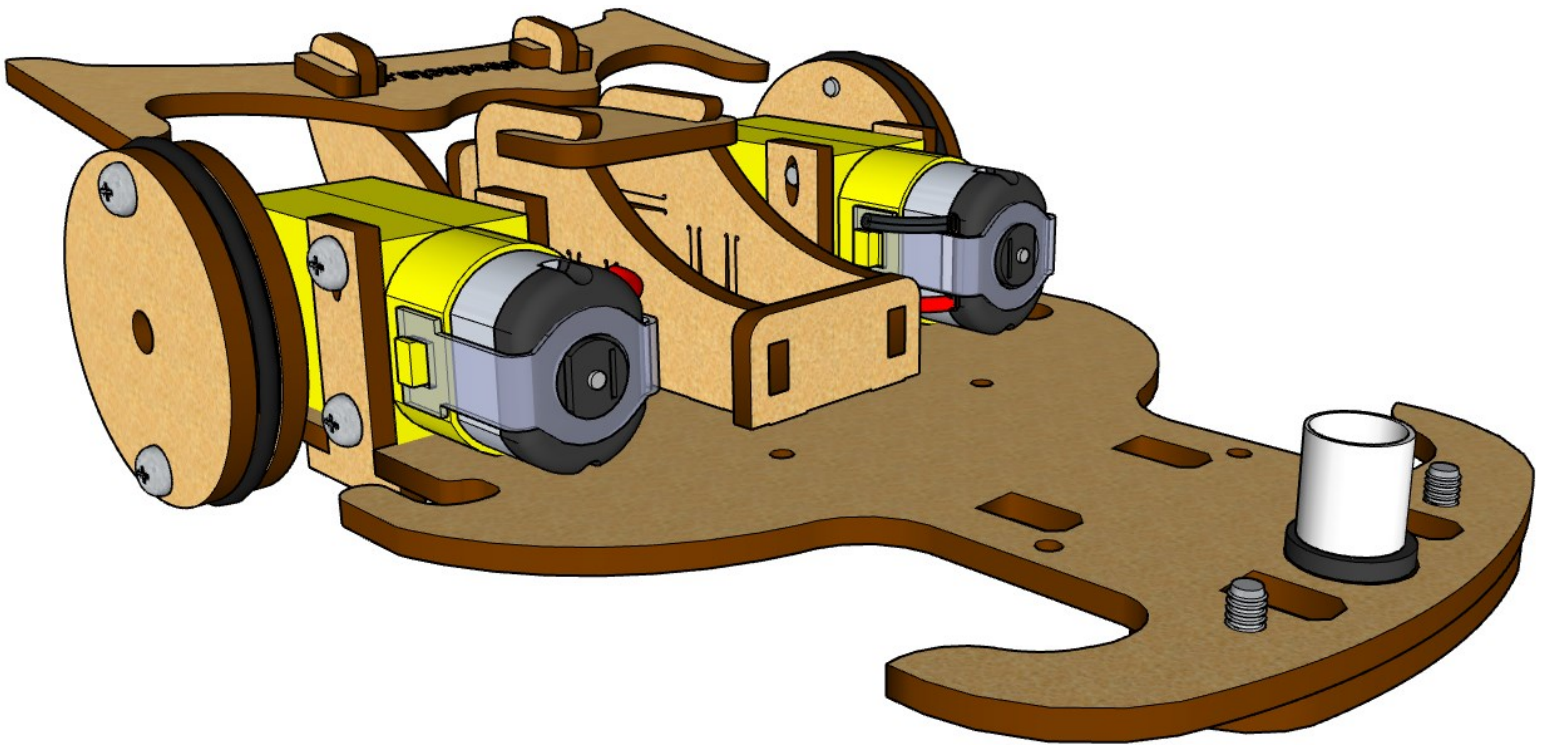

Para poder armar **Seguidor de Línea Básico V.2** identifica las siguientes piezas.

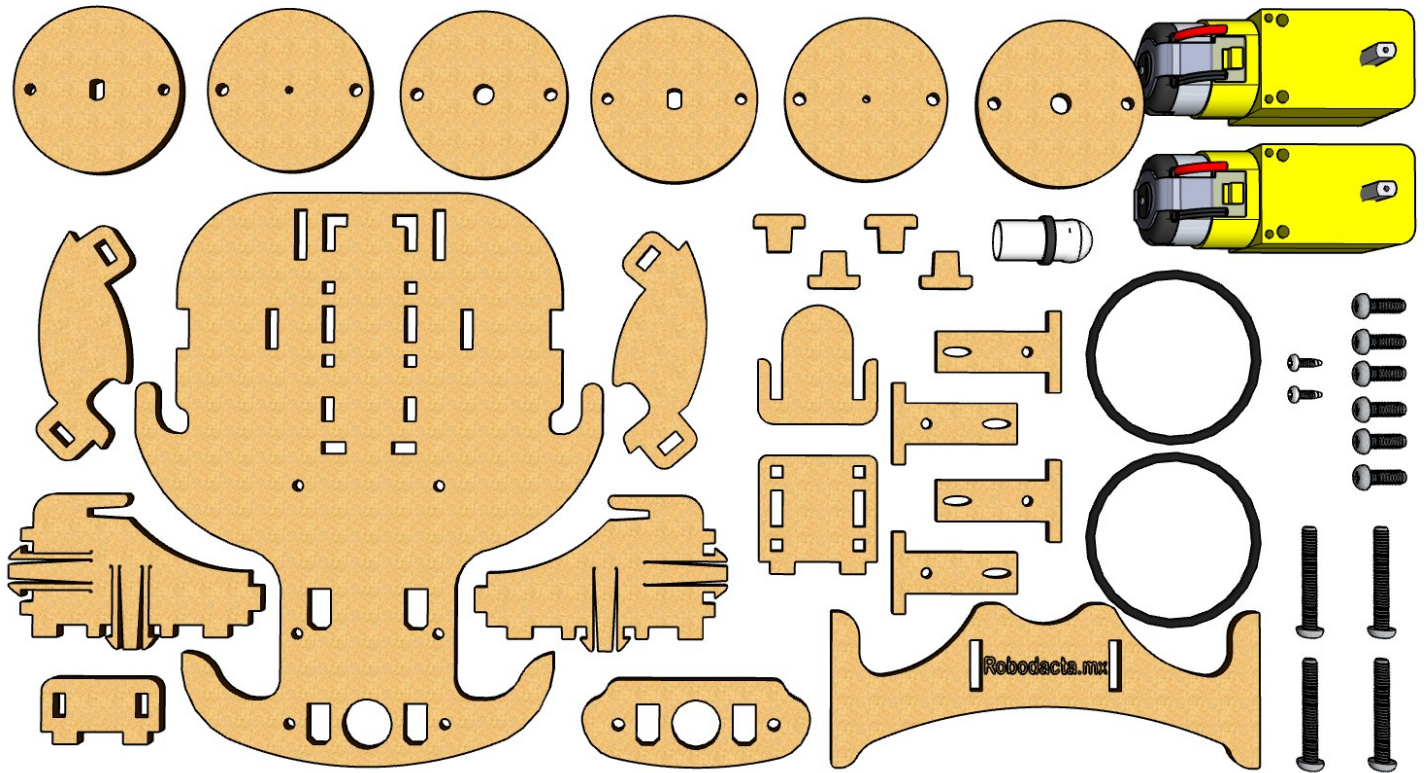

Nota: Compara tus tornillos en el apartado de la tornillería.



1

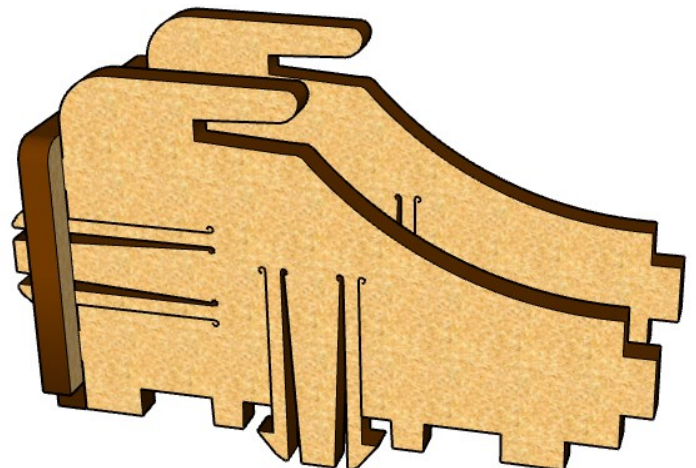
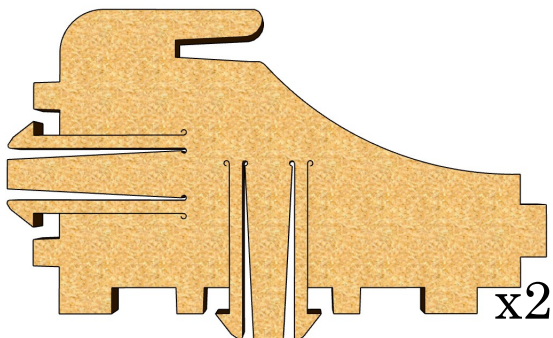
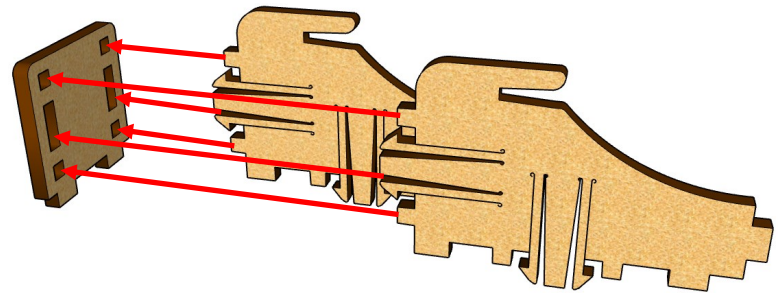
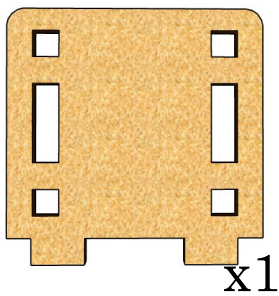



2

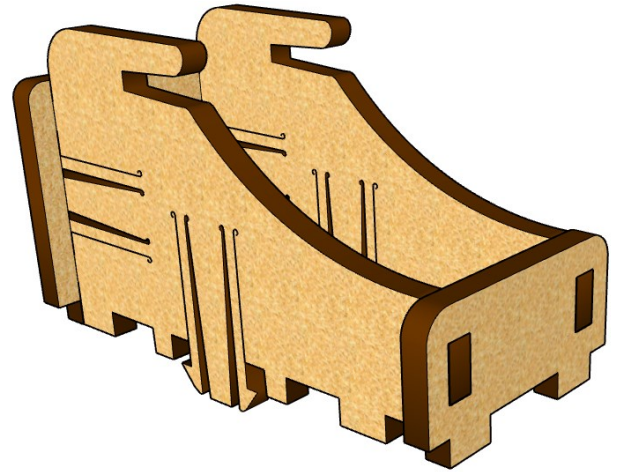
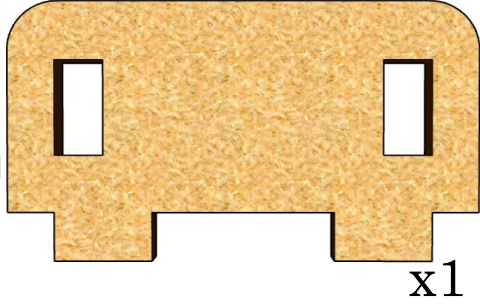
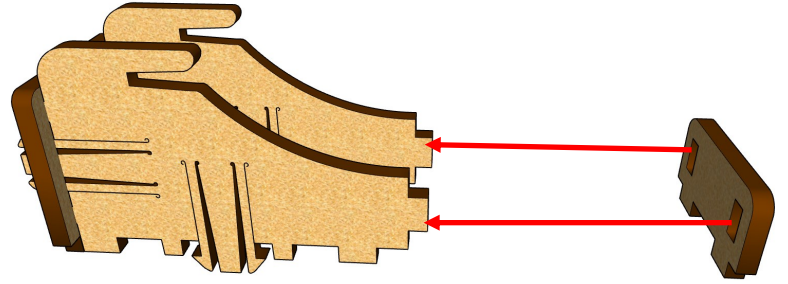

3

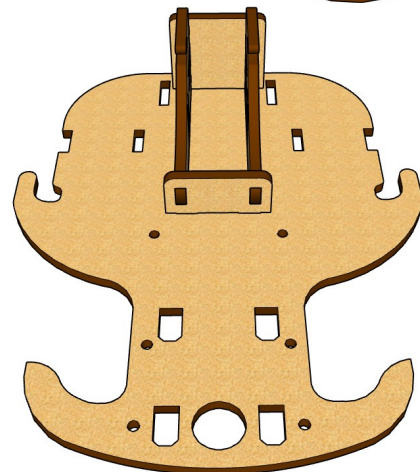
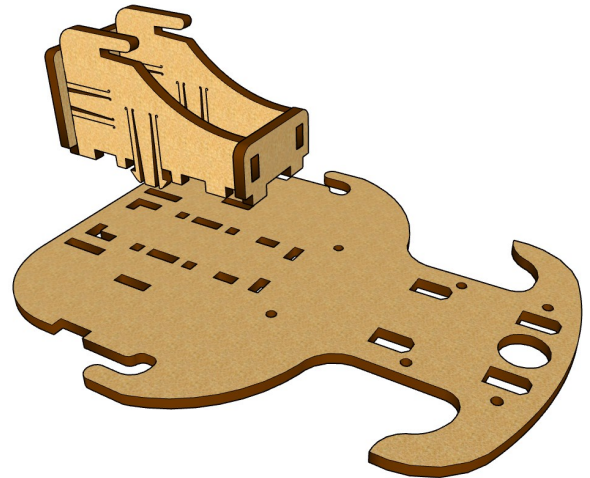
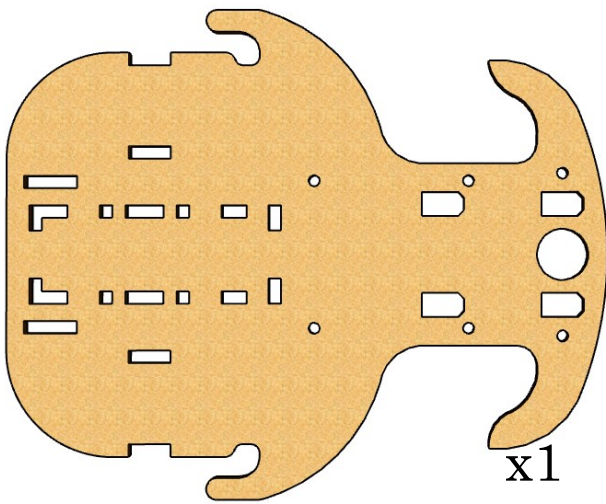



4

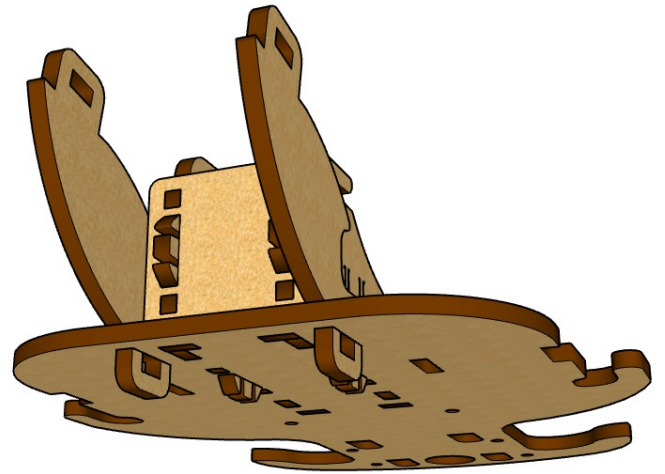
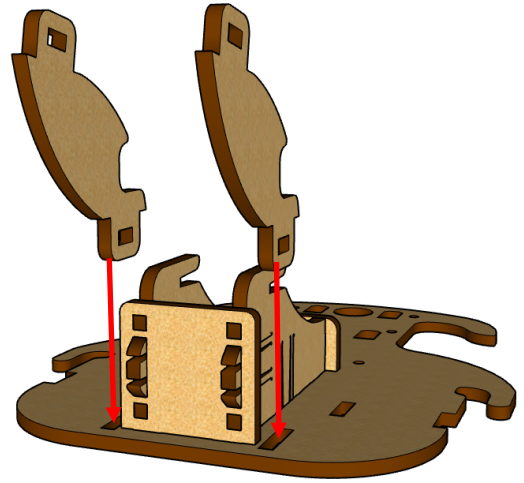
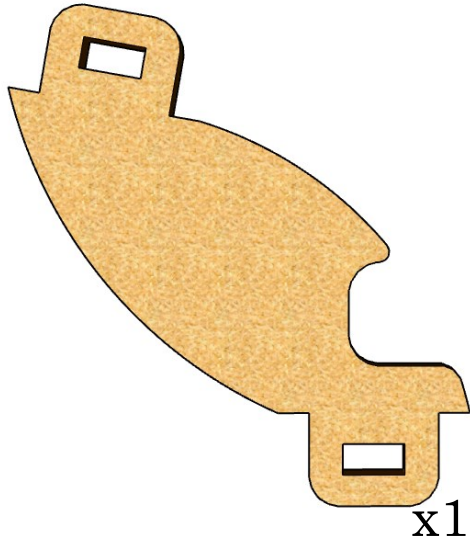

5

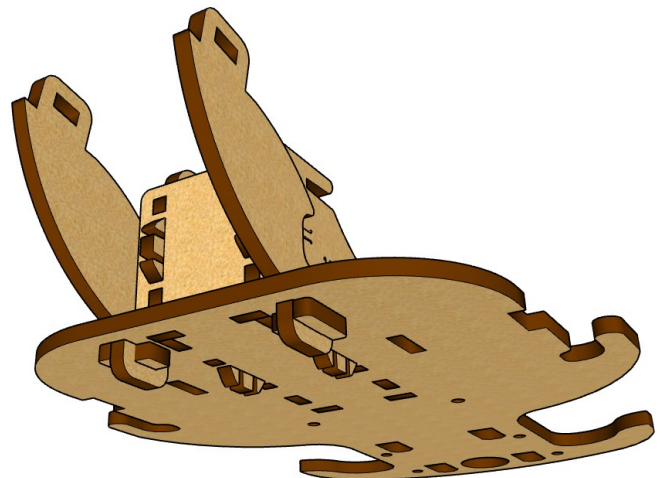
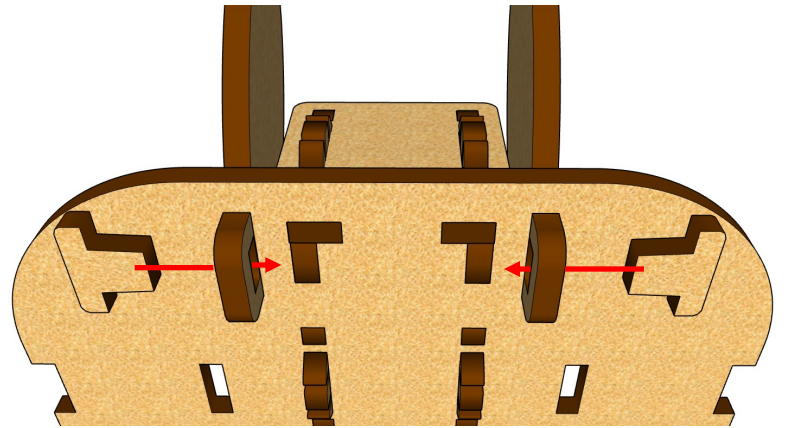
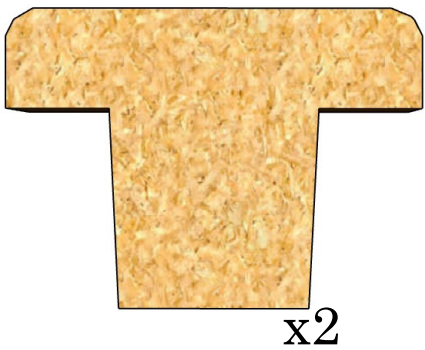



6

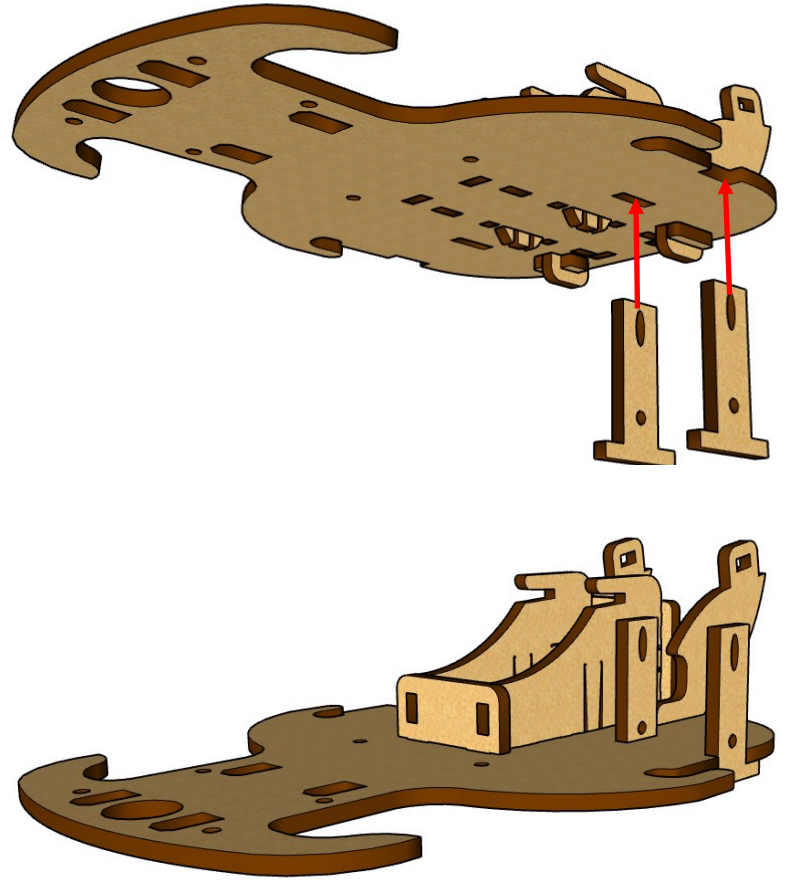
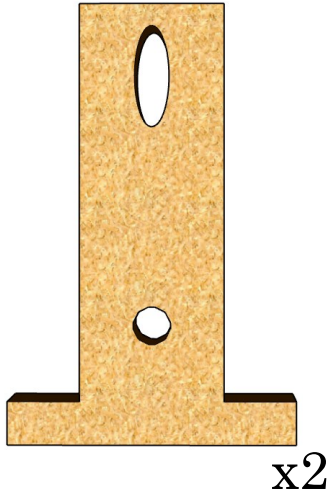

7

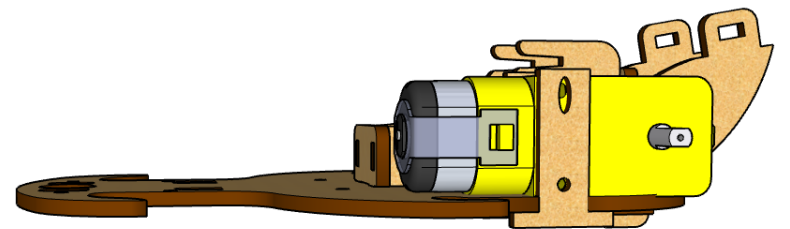
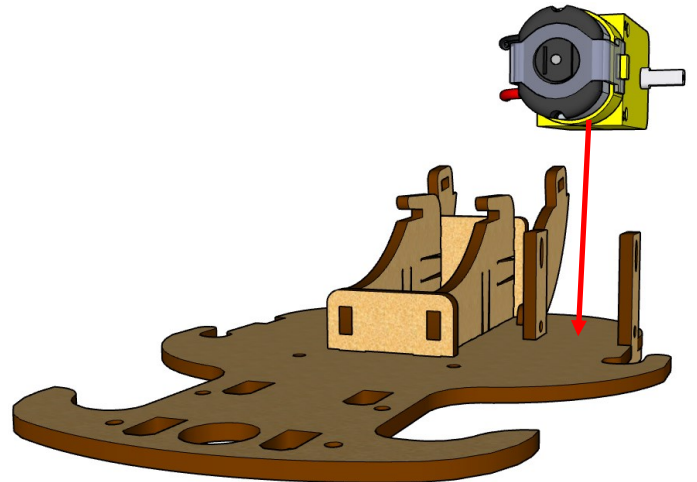
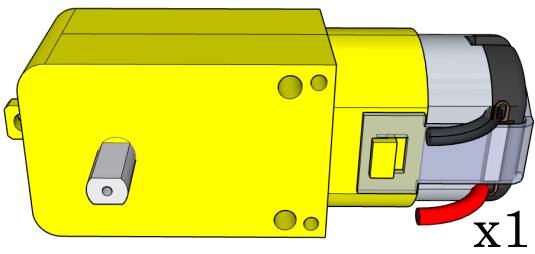



8

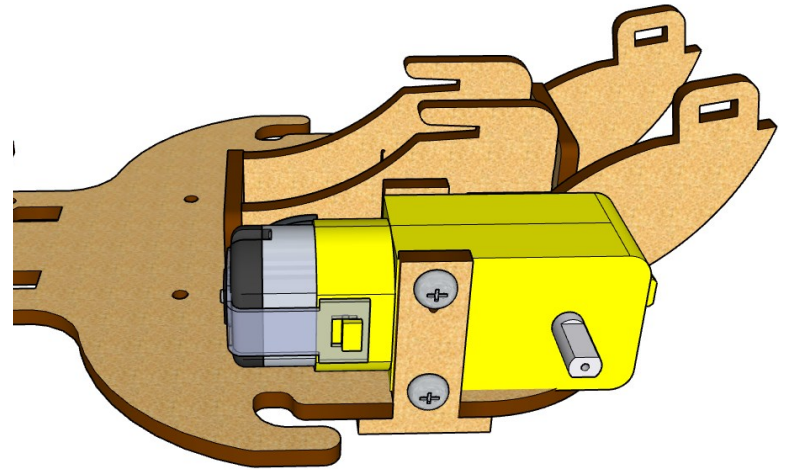
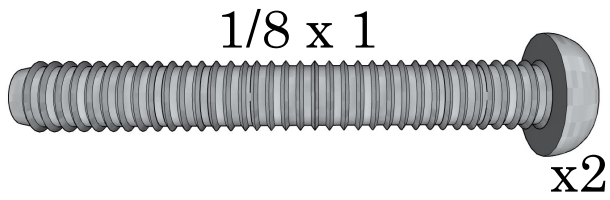
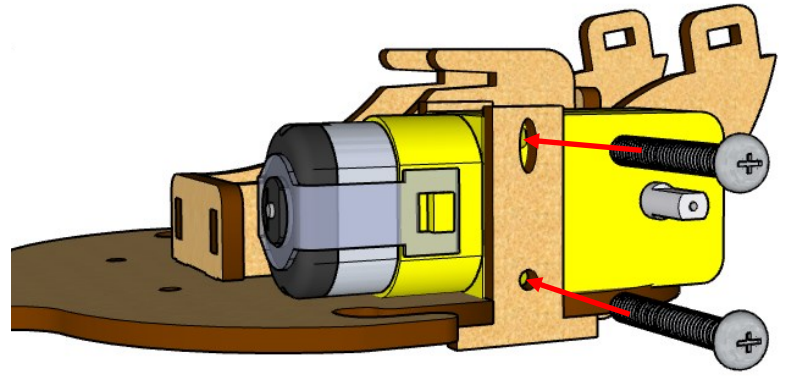

9

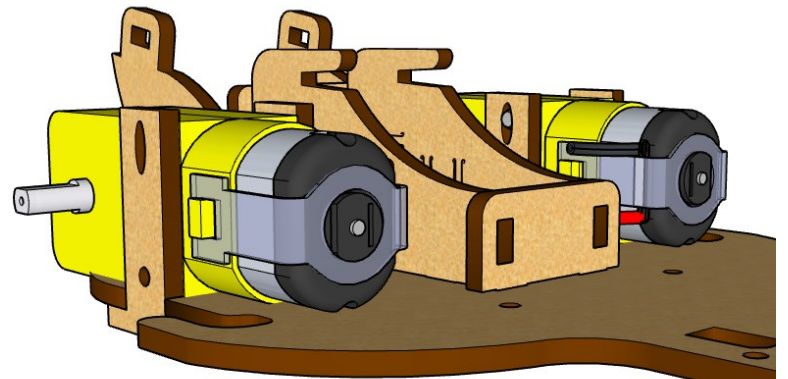
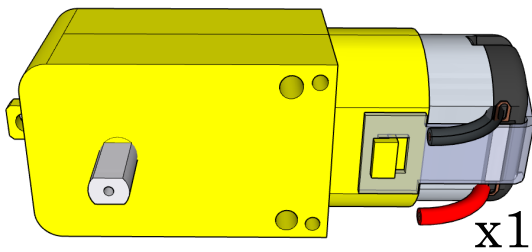
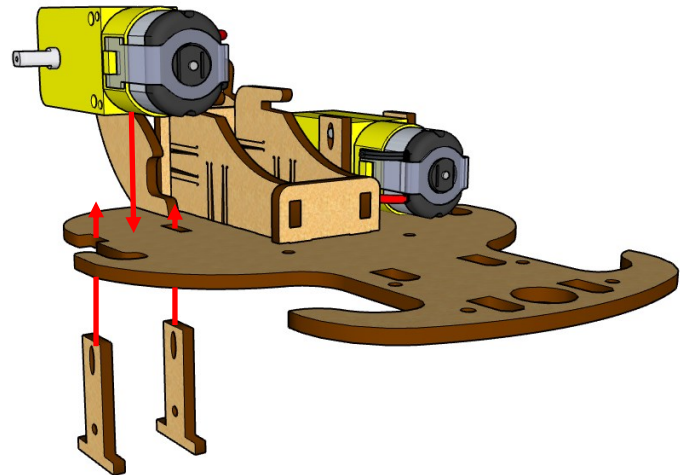
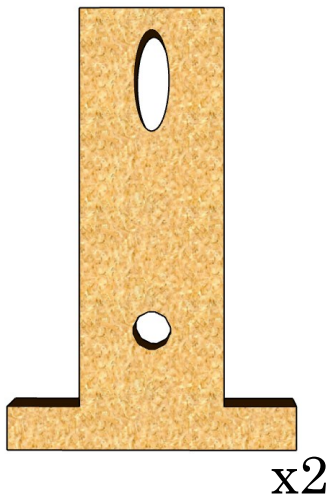



10

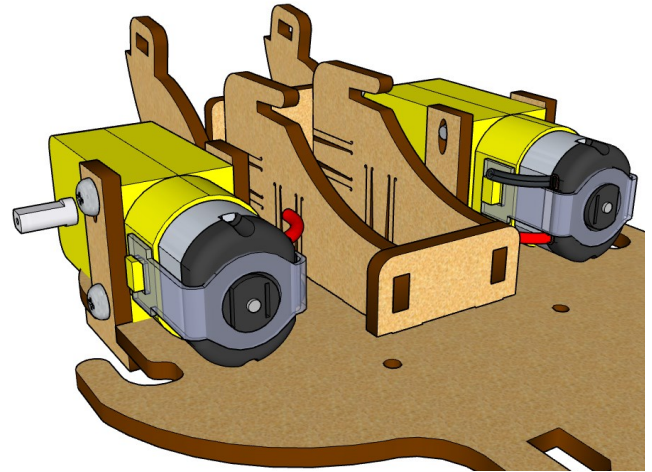
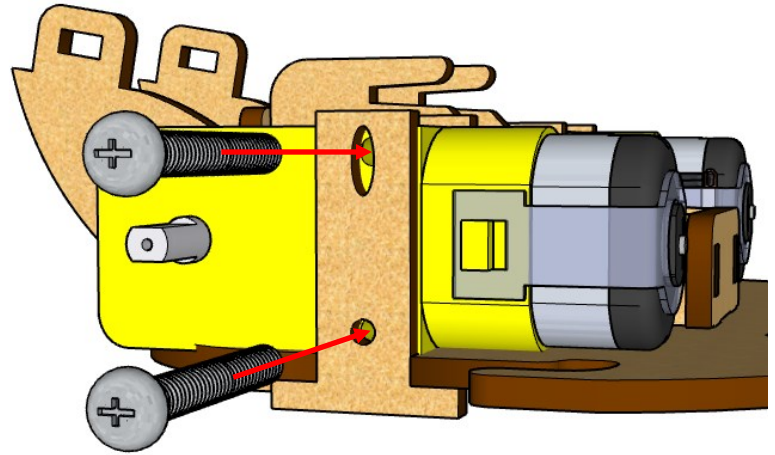
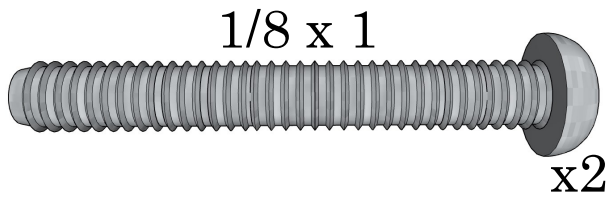

11

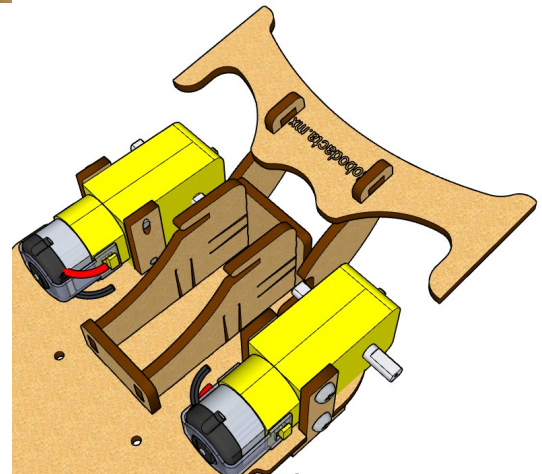
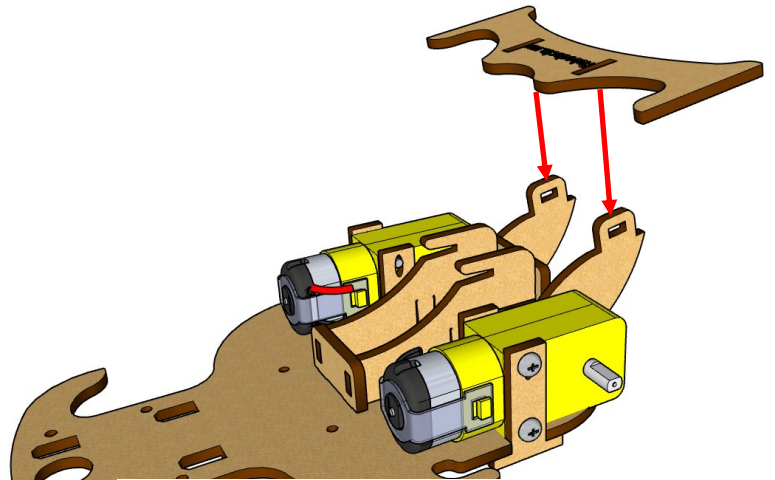
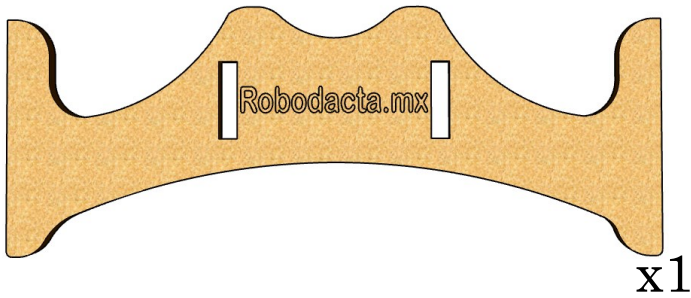



12

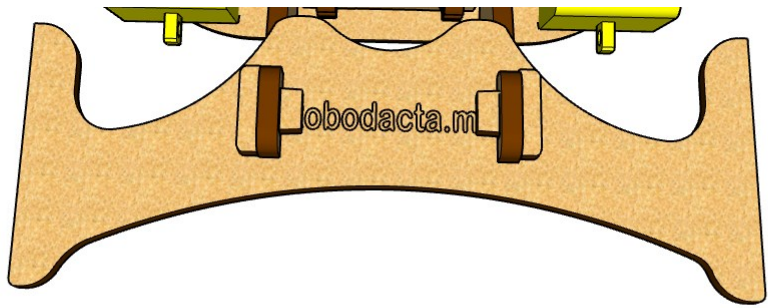
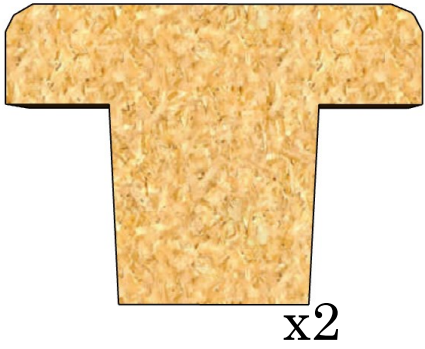

13

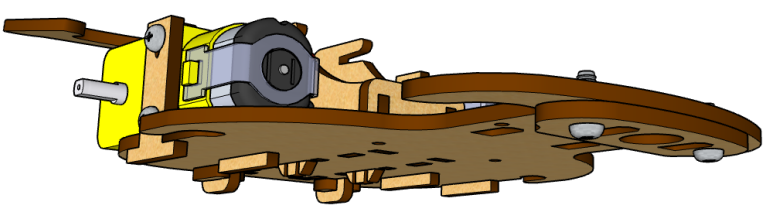
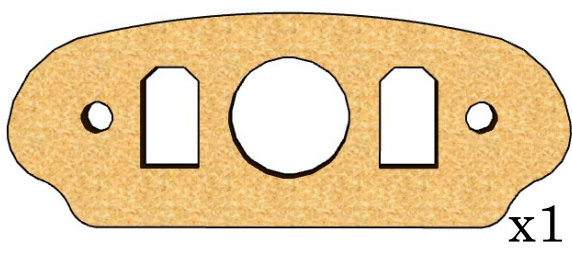
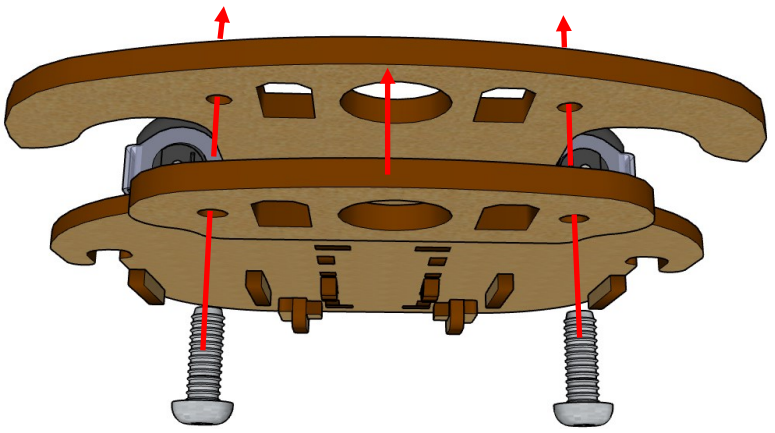
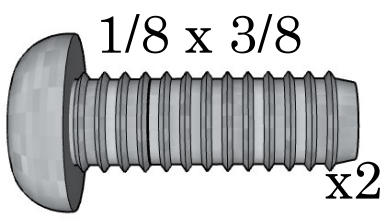



14

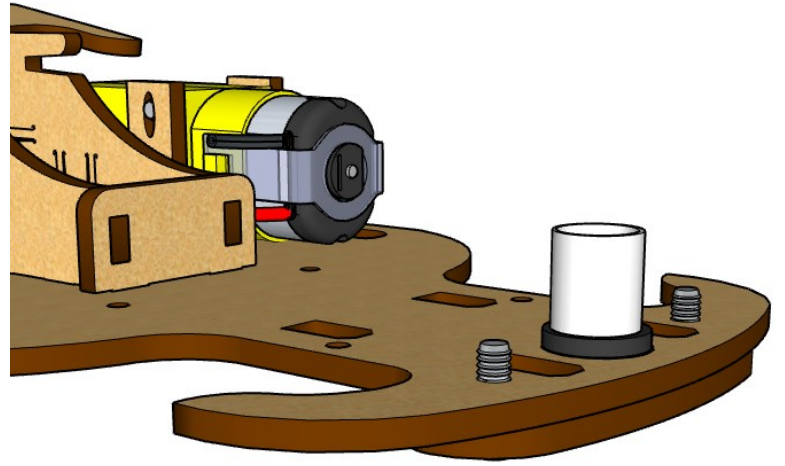
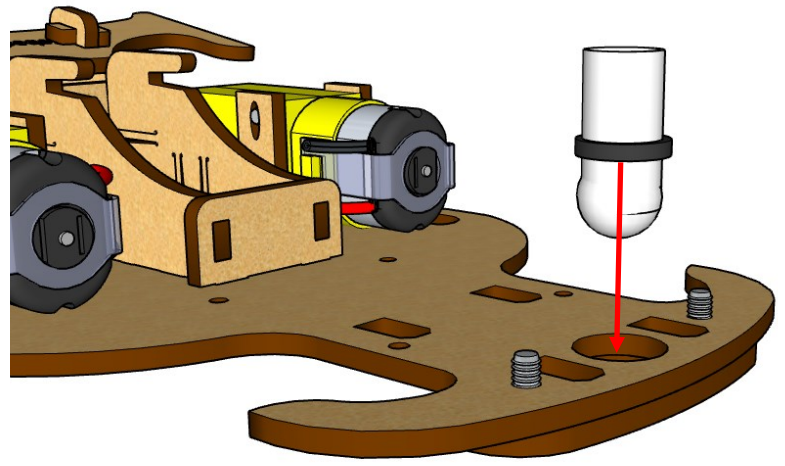
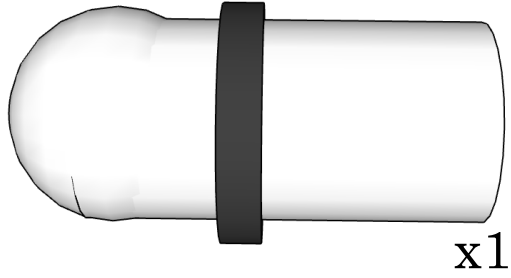

15

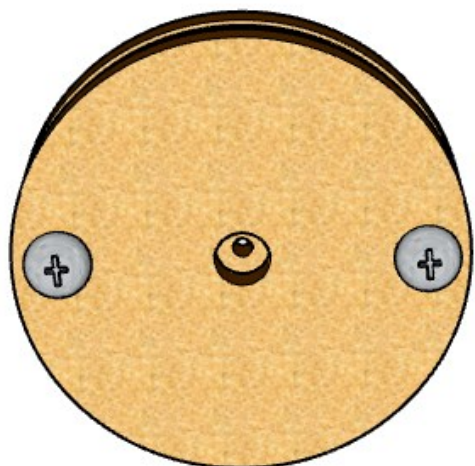
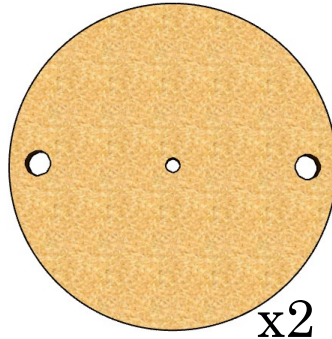
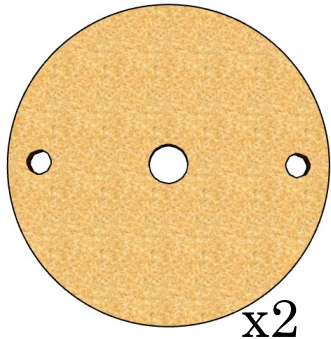
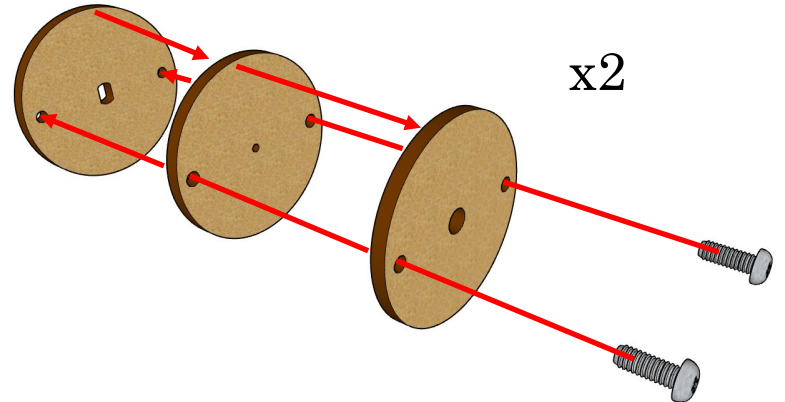
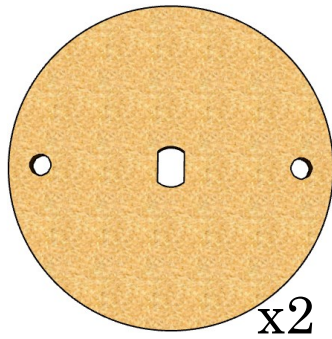
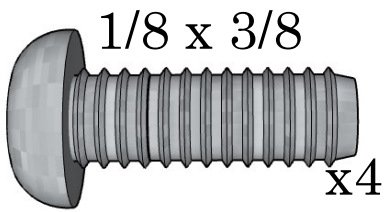



16

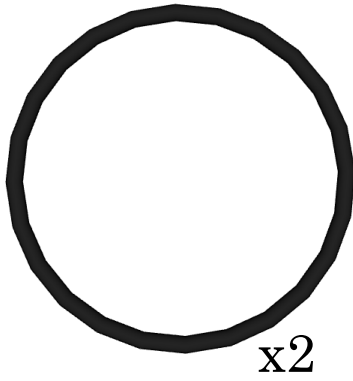

x2

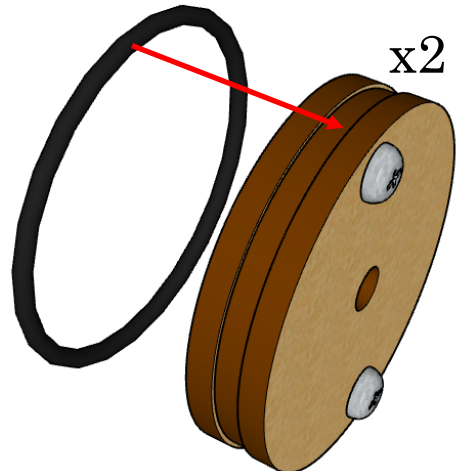

x2

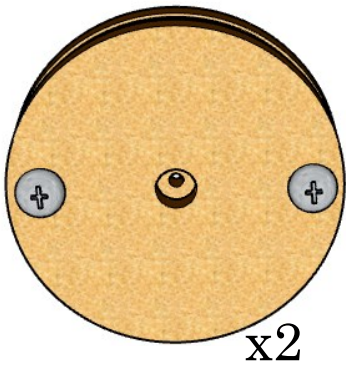

x2

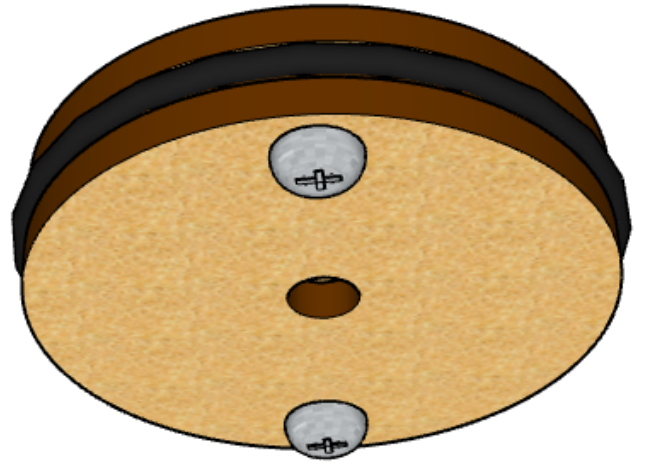

17

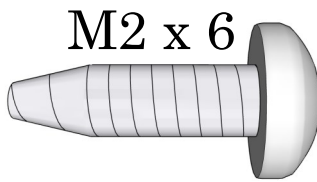

M2 x 6

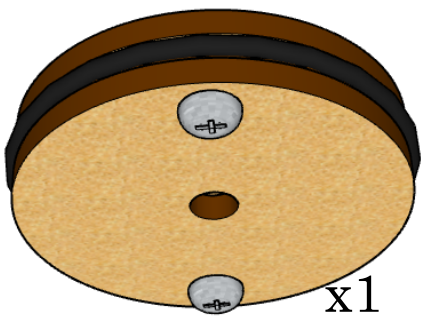
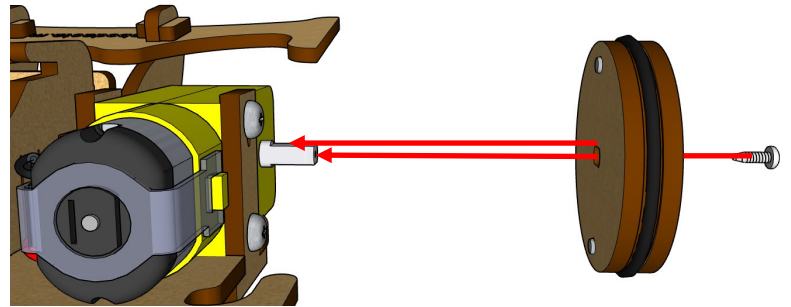

x1

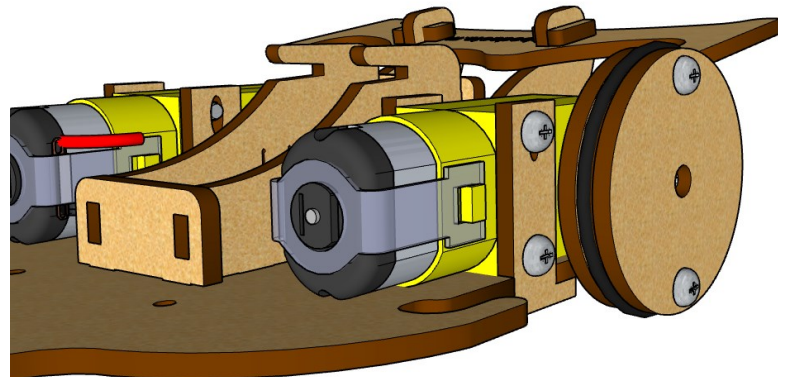



18

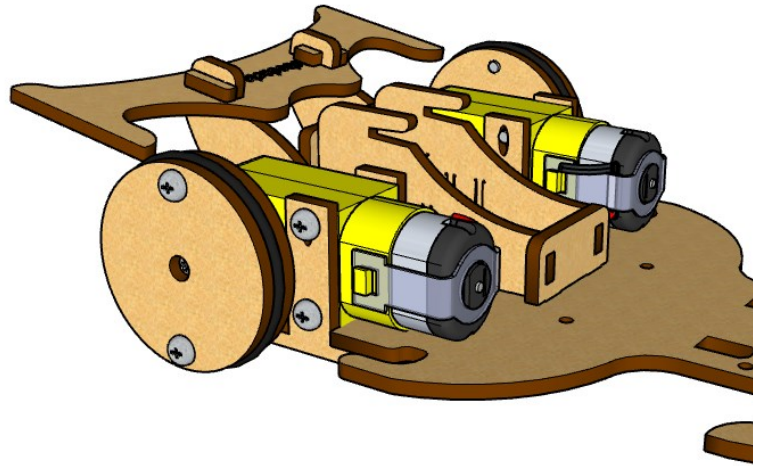
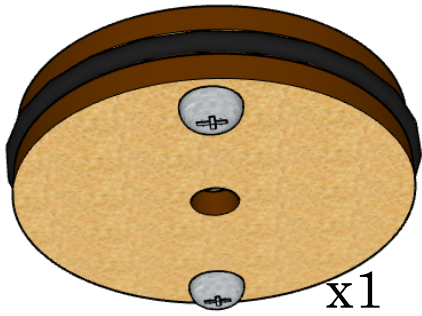
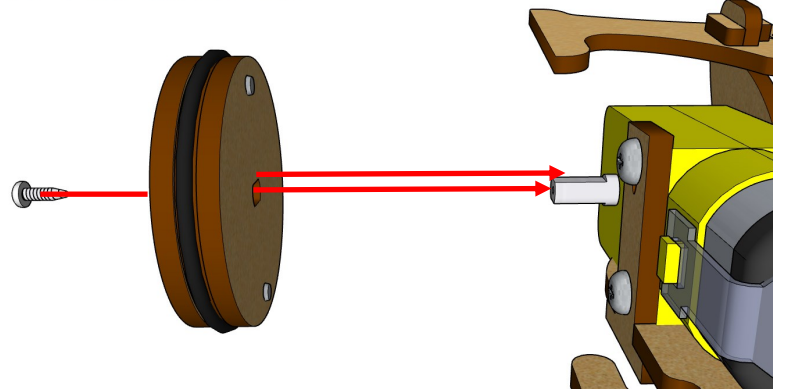
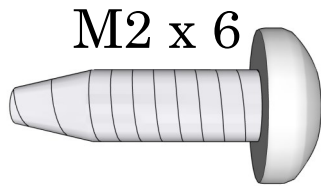

19

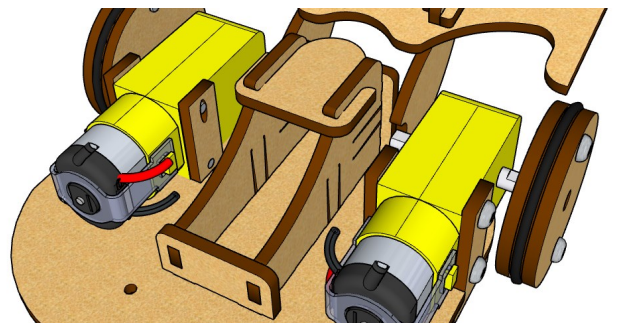
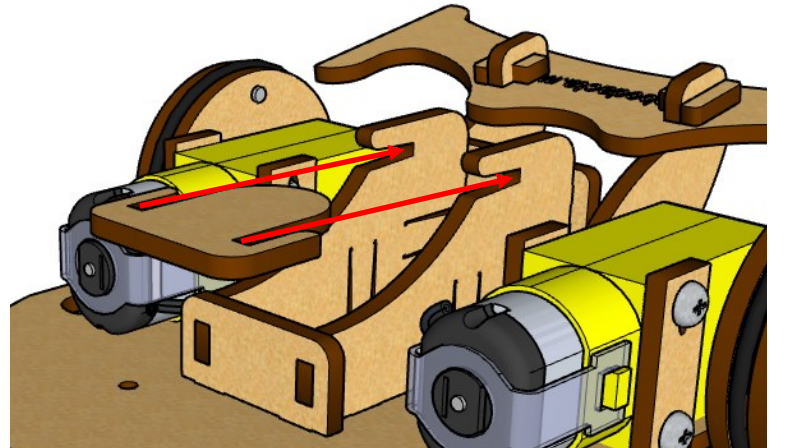
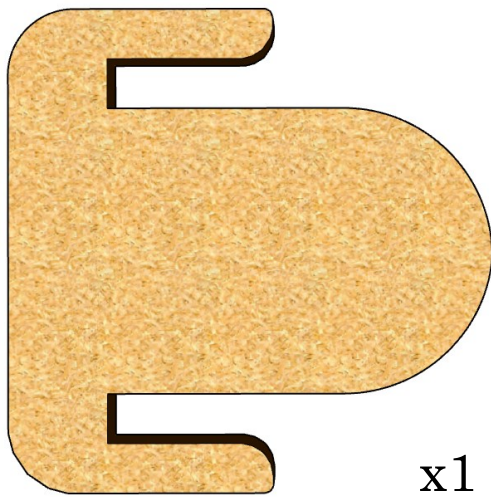

Para terminar de armar el kit identifica el manual que necesitas par concluir.

Tornillería

Utiliza el siguiente esquema para comparar y conocer las medidas de los tornillos y tuercas que necesitas durante el ensamble. Solo basta con colocar encima el tornillo o tuerca hasta que coincida con alguna de las figuras. (Para corroborar correctamente las medidas de los tornillos imprime esta hoja)

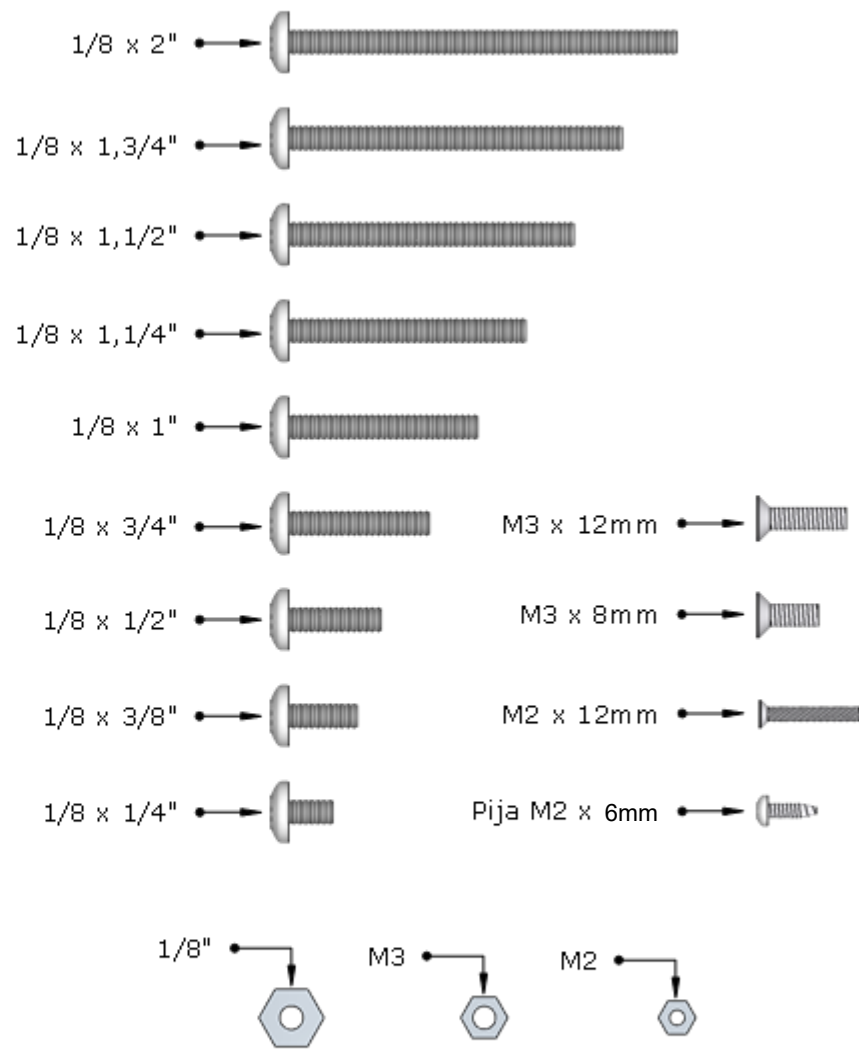

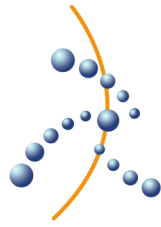

robodacta.mx
robótica didáctica

No te olvides visitar nuestro sitio web y seguirnos en nuestras redes sociales donde encontrarás más contenido.

www.robodacta.mx



@Robodacta.RD



56 28 08 95 23



@robodacta.mx



RobodactaMx