

robodacta.mx
robótica didáctica

Manual de ensamble
Carrito F1 con Liga
Código KIT-1411

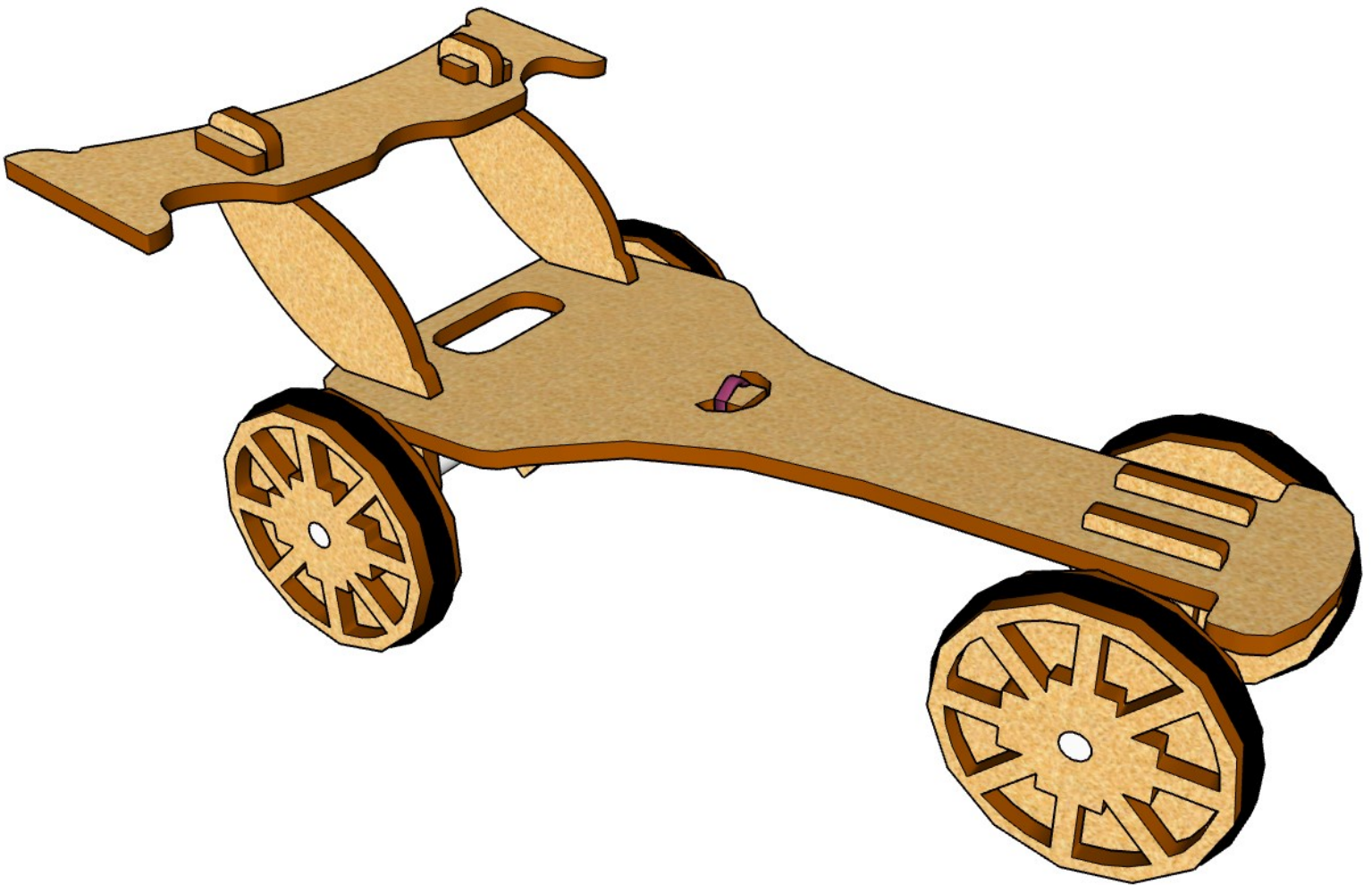

Para poder armar **Negritas** identifica las siguientes piezas.

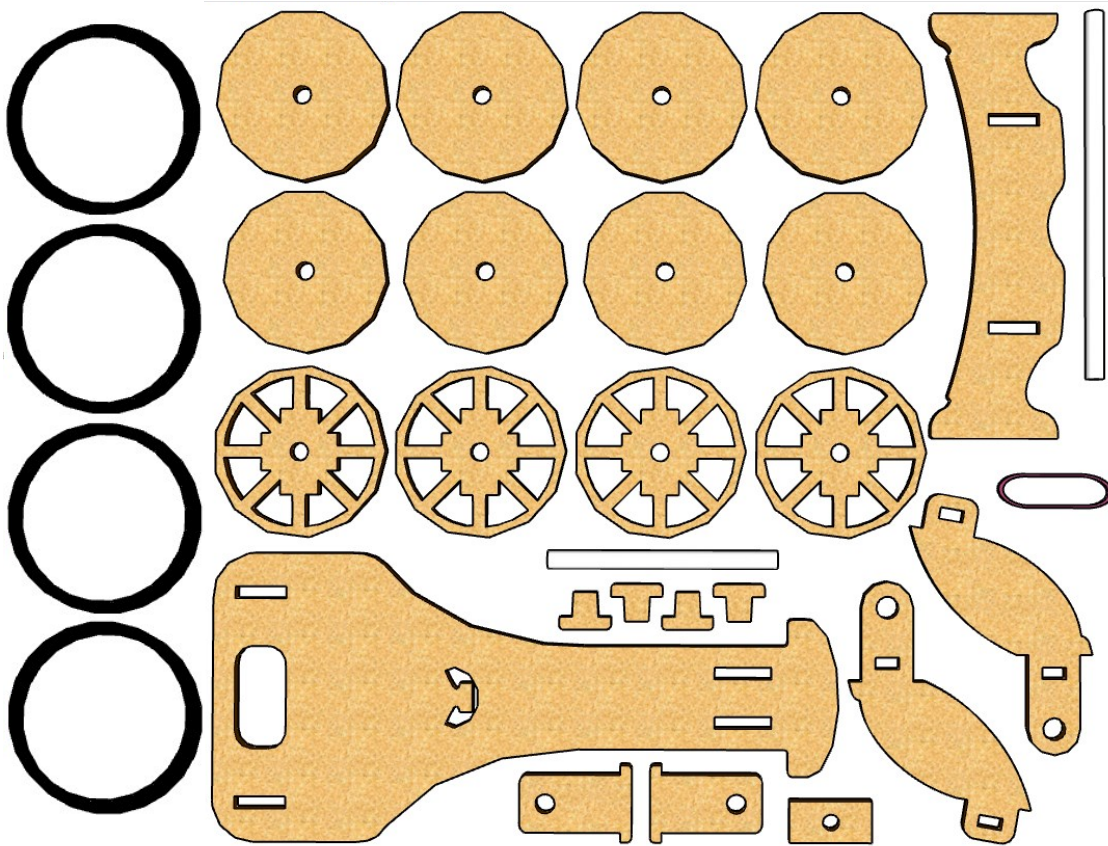

Utiliza pegamento blanco (no incluido) en donde se indica con la siguiente imagen.



1

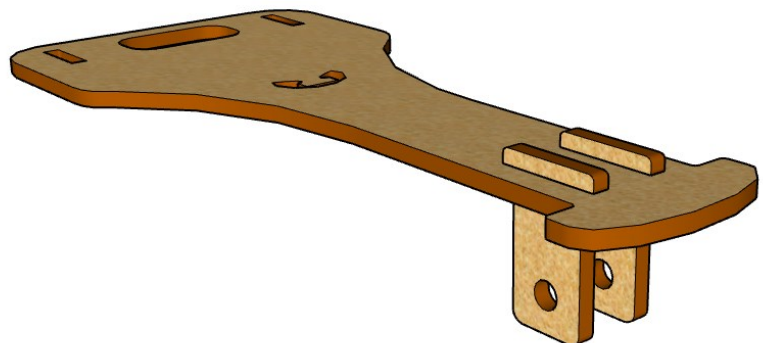
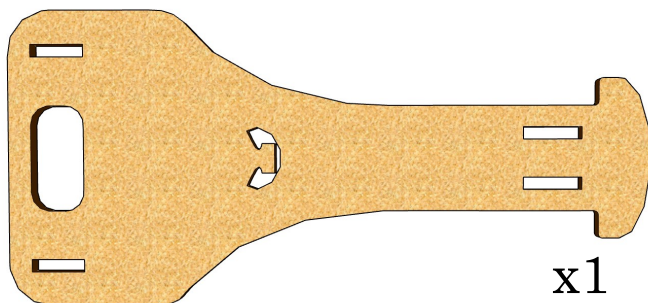
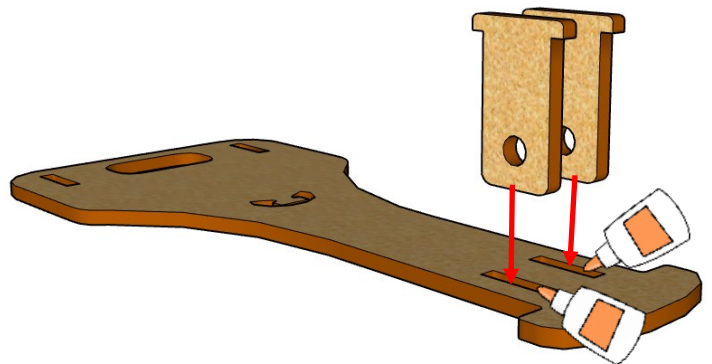



2

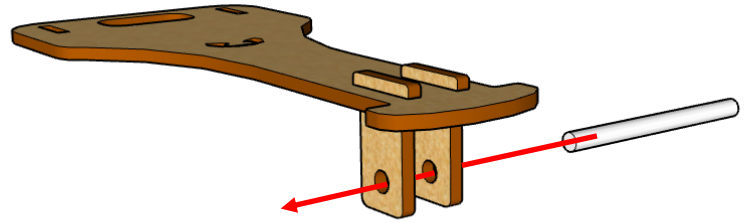

3

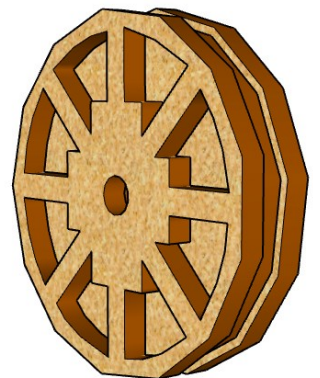
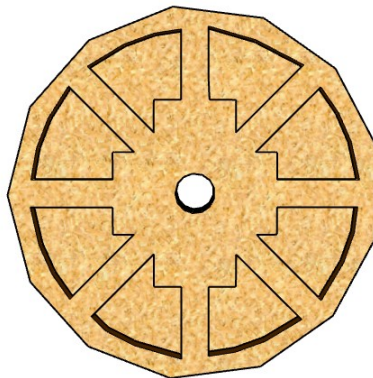
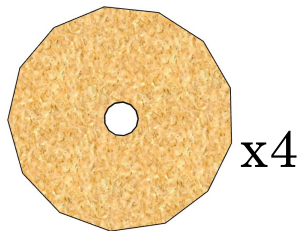
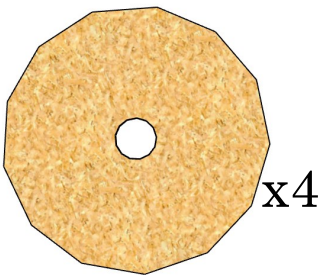
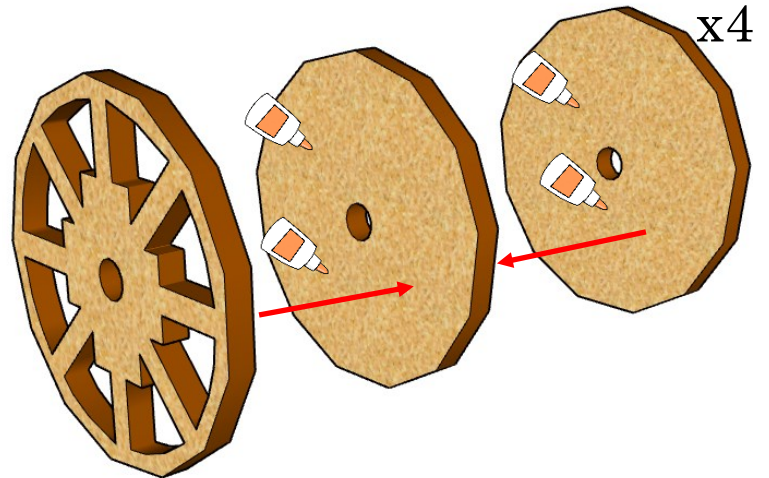
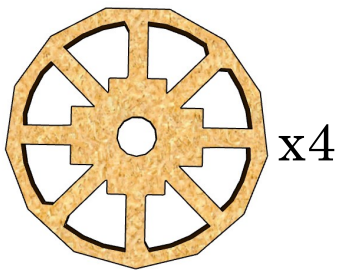

Notas: Una de las ruedas debe ser más pequeña que las demás, colócale en el medio.



4

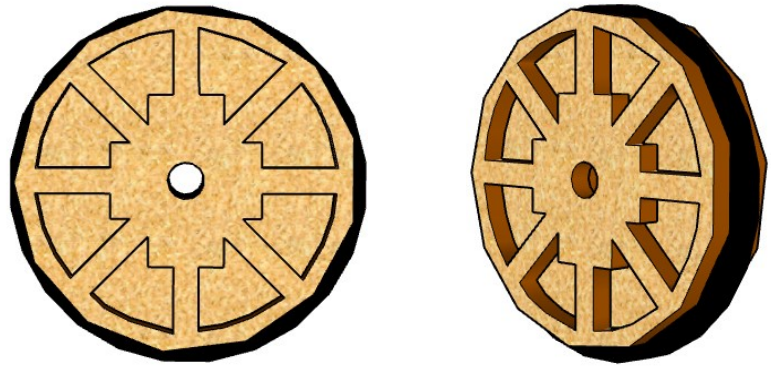
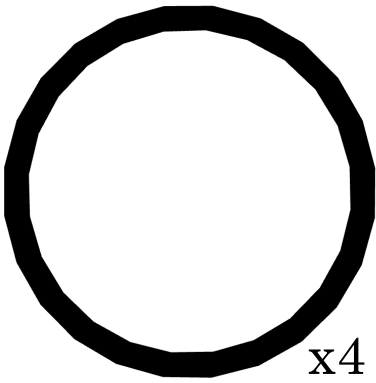
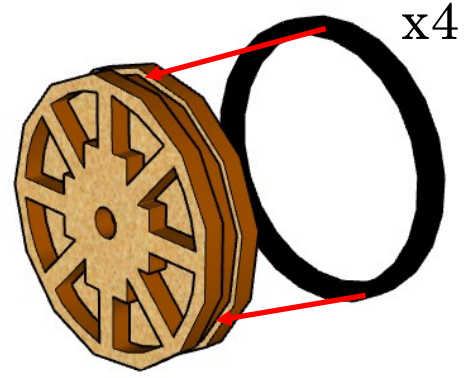
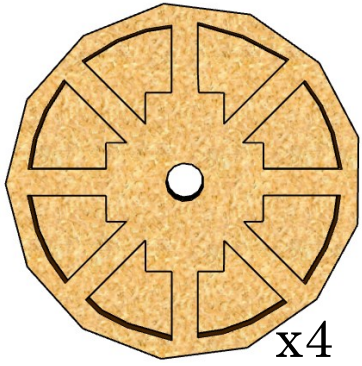

5

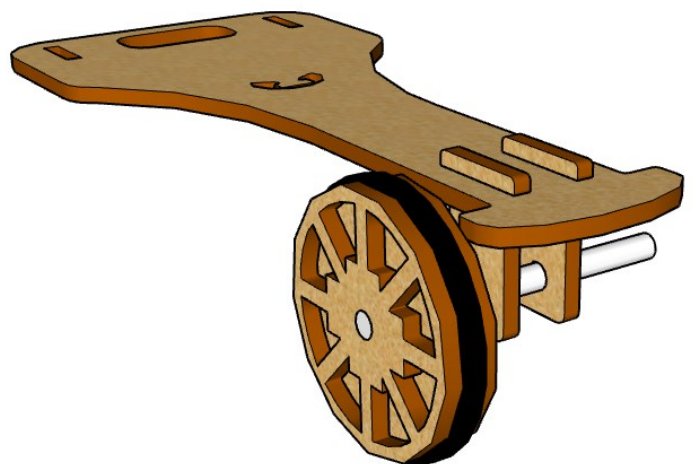
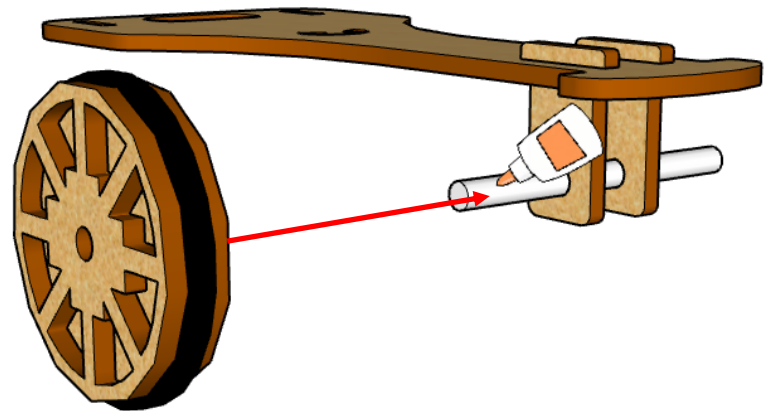
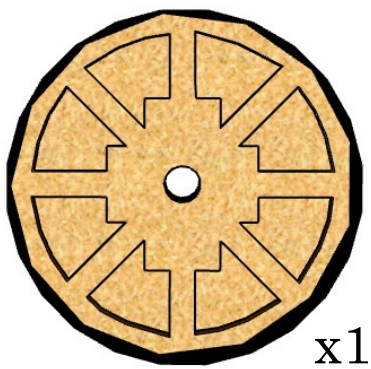



6

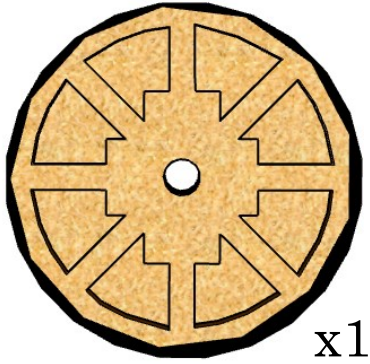

x1

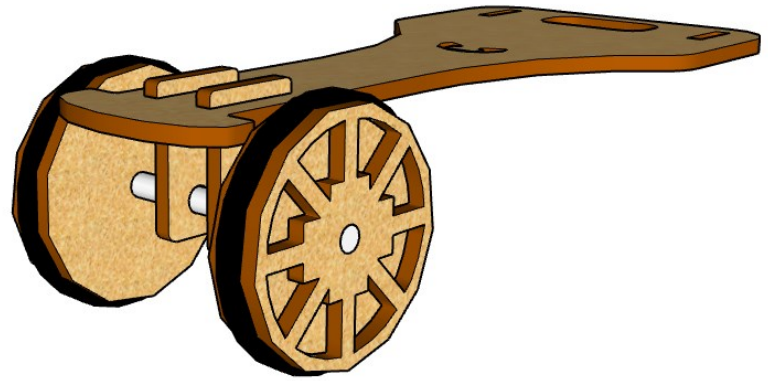
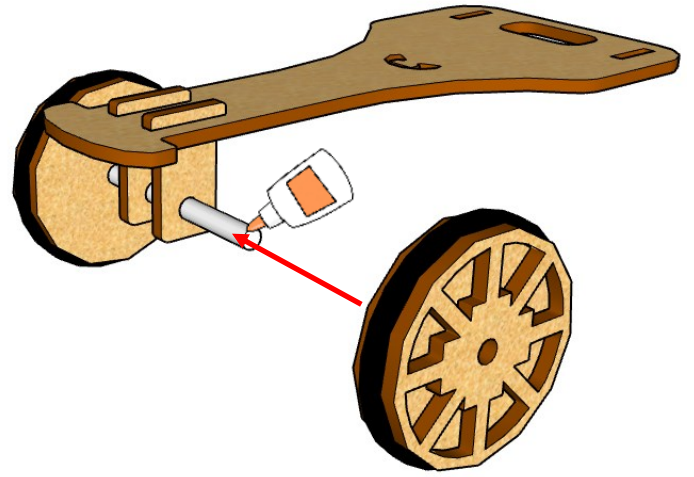

7

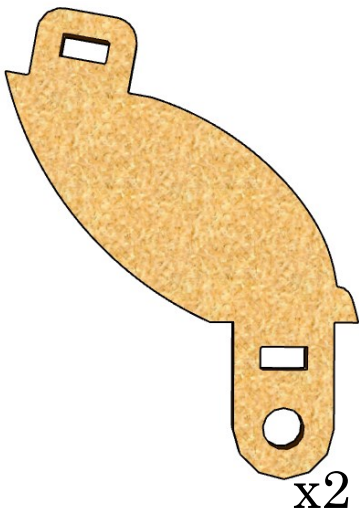

x2

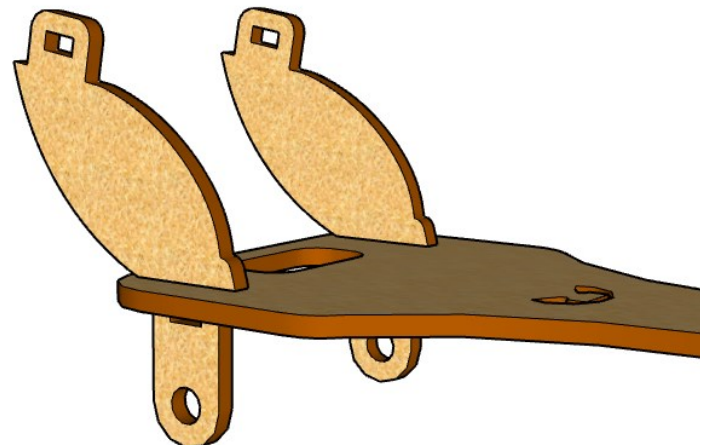
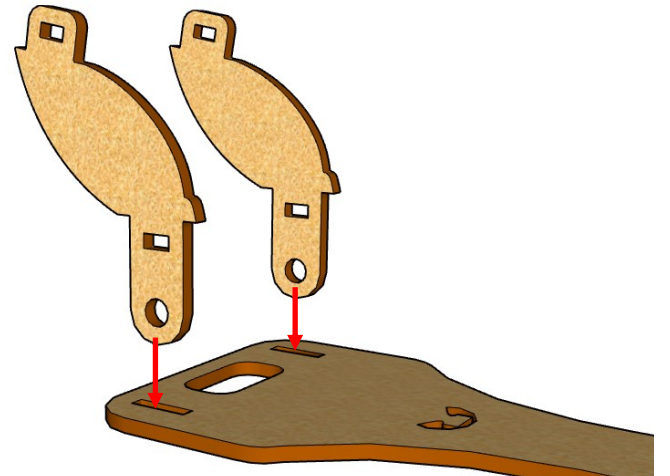



8

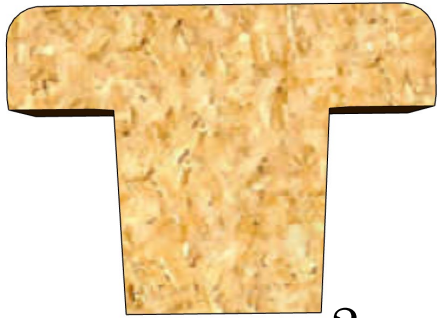

x2

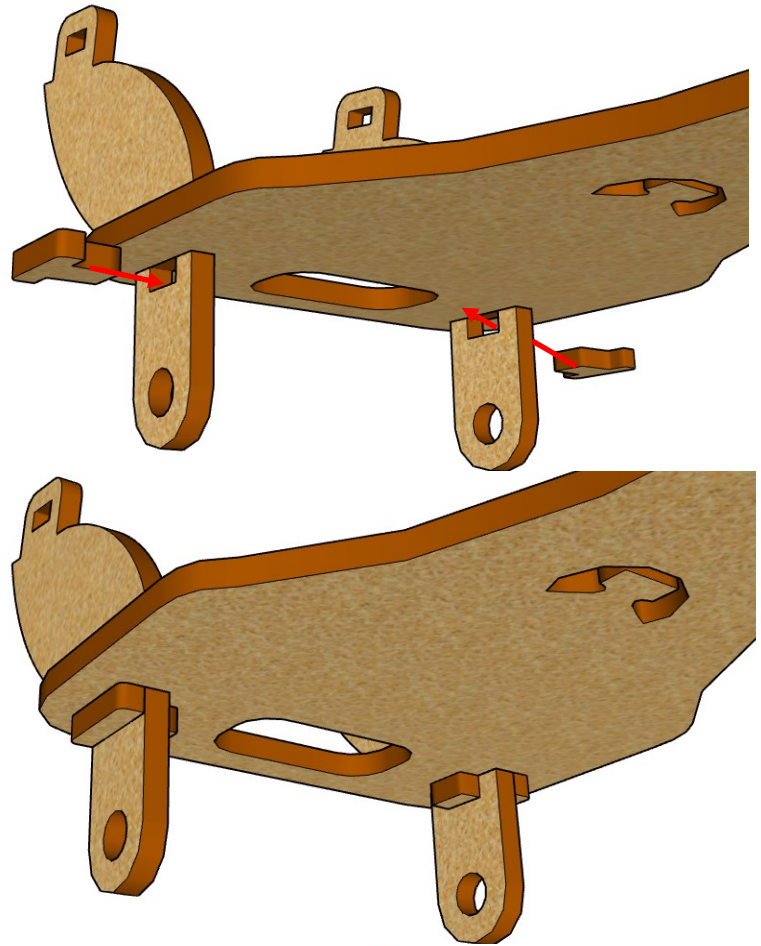

9

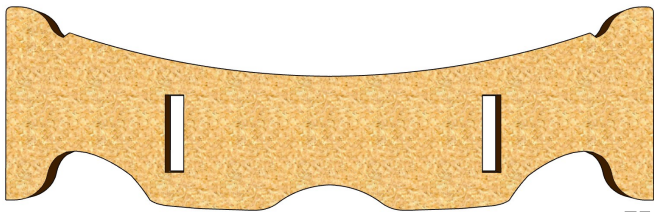

x1

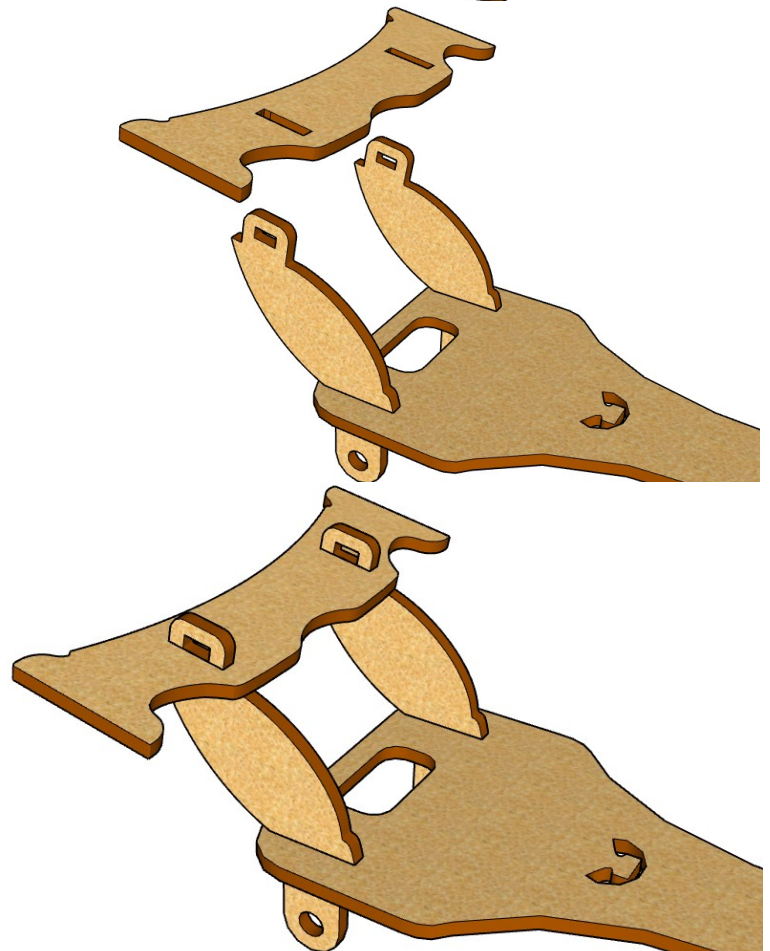



10

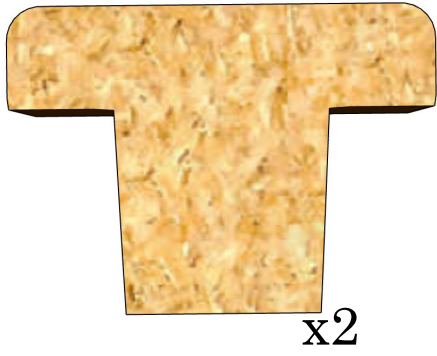

x2

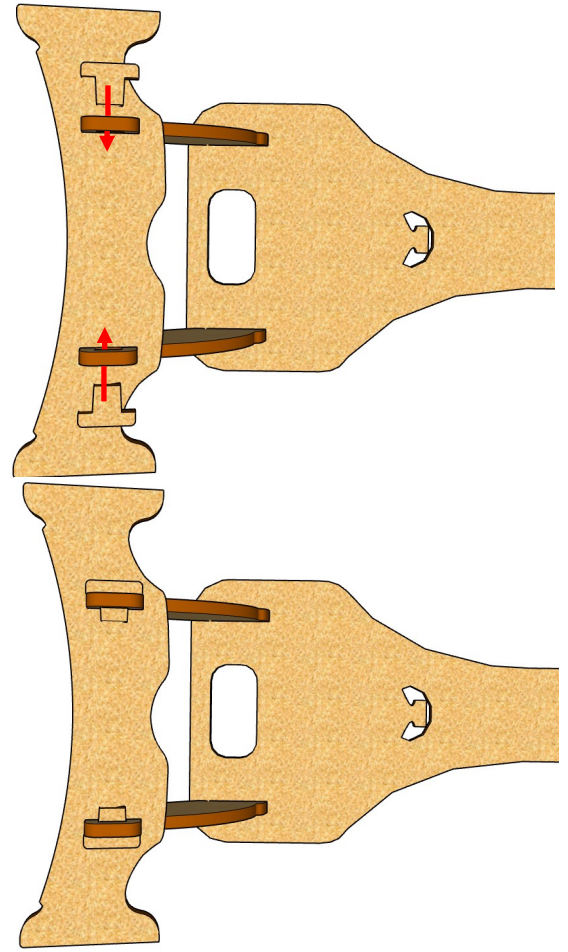

11



x1

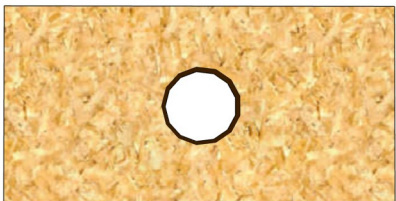

x1

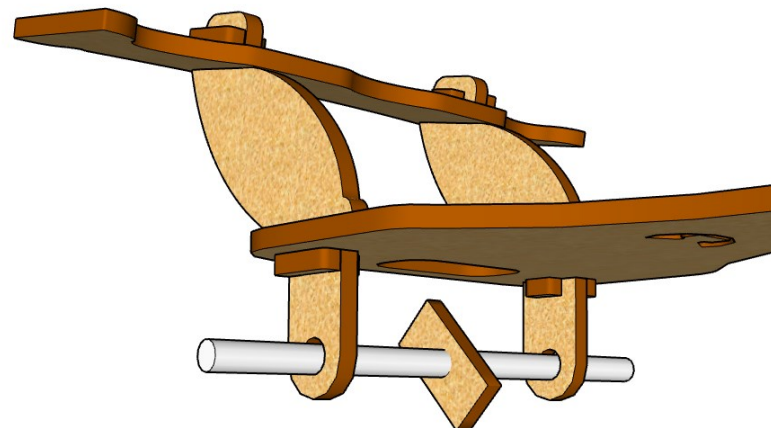
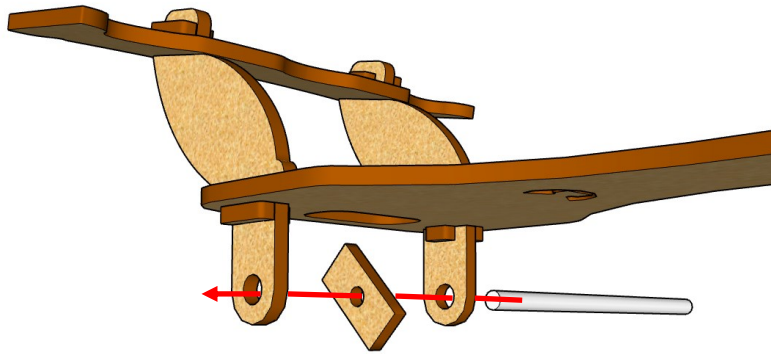



12

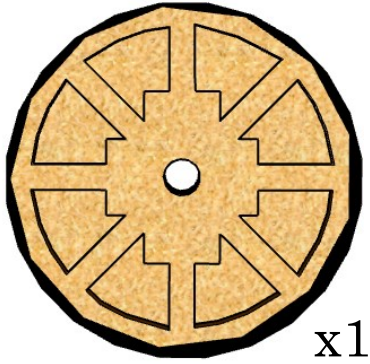

x1

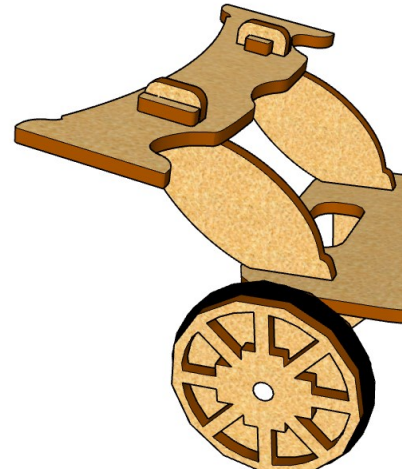
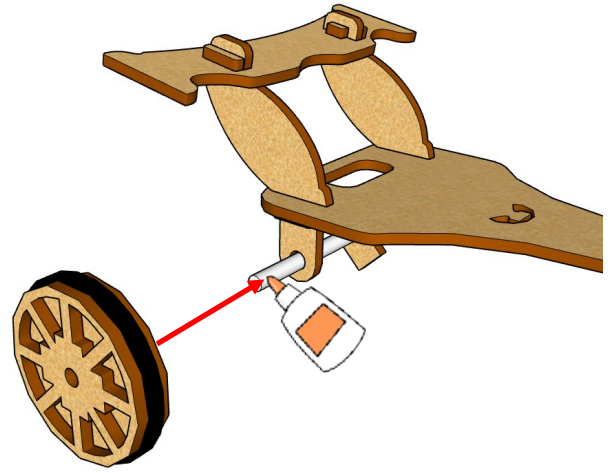

13

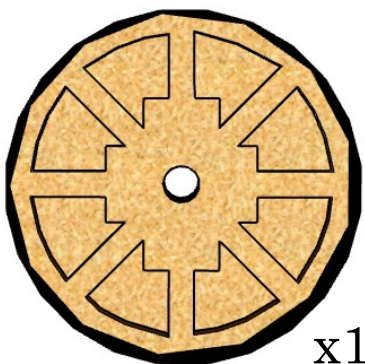

x1

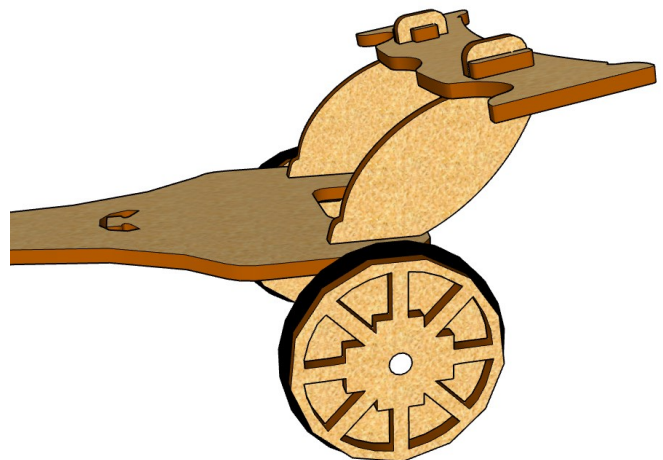
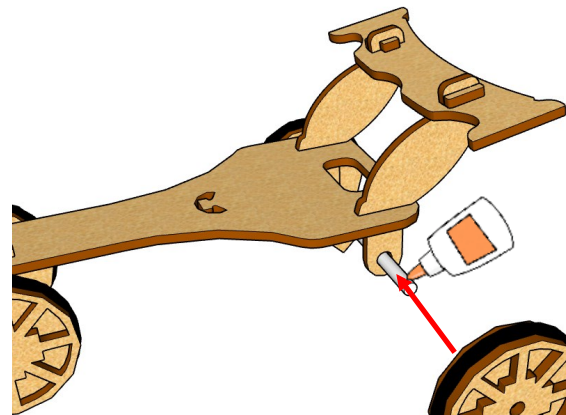



14

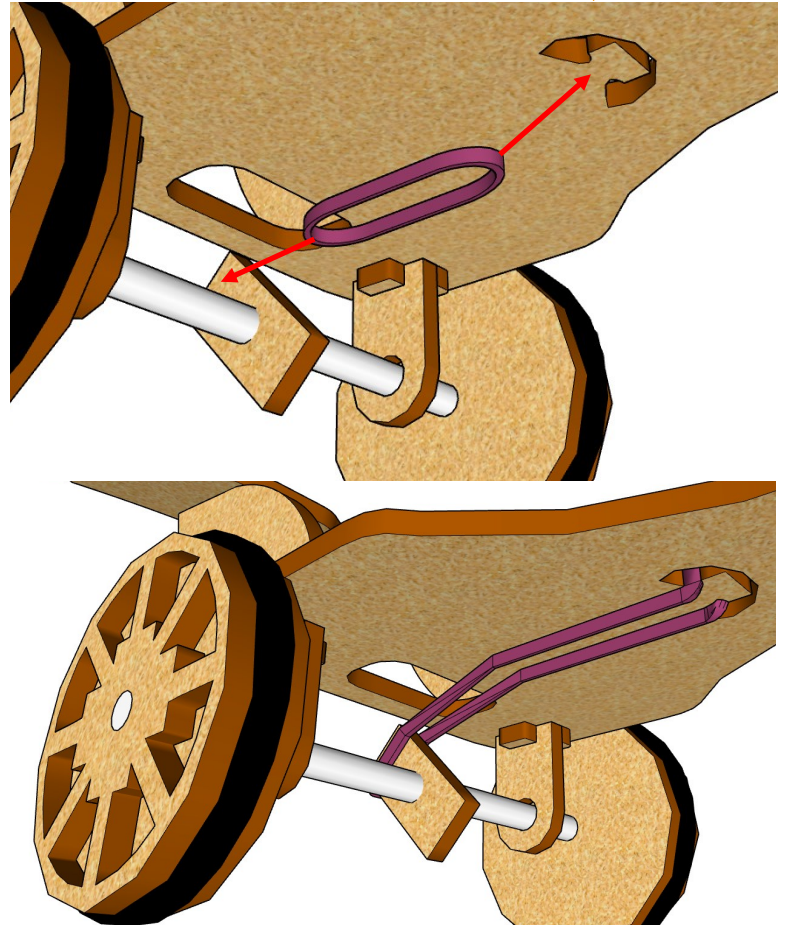
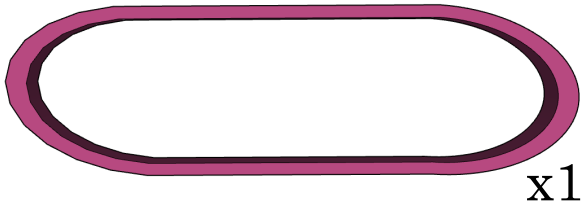

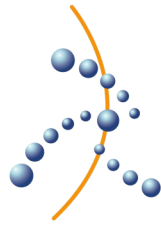

robodacta.mx
robótica didáctica

No te olvides visitar nuestro sitio web y seguirnos en nuestras redes sociales donde encontrarás más contenido.

www.robodacta.mx



@Robodacta.RD



56 28 08 95 23



@robodacta.mx



RobodactaMx