

robodacta.mx
robótica didáctica

Manual de ensamble
Seguidor de línea velocista V2
Código **KIT-1212**

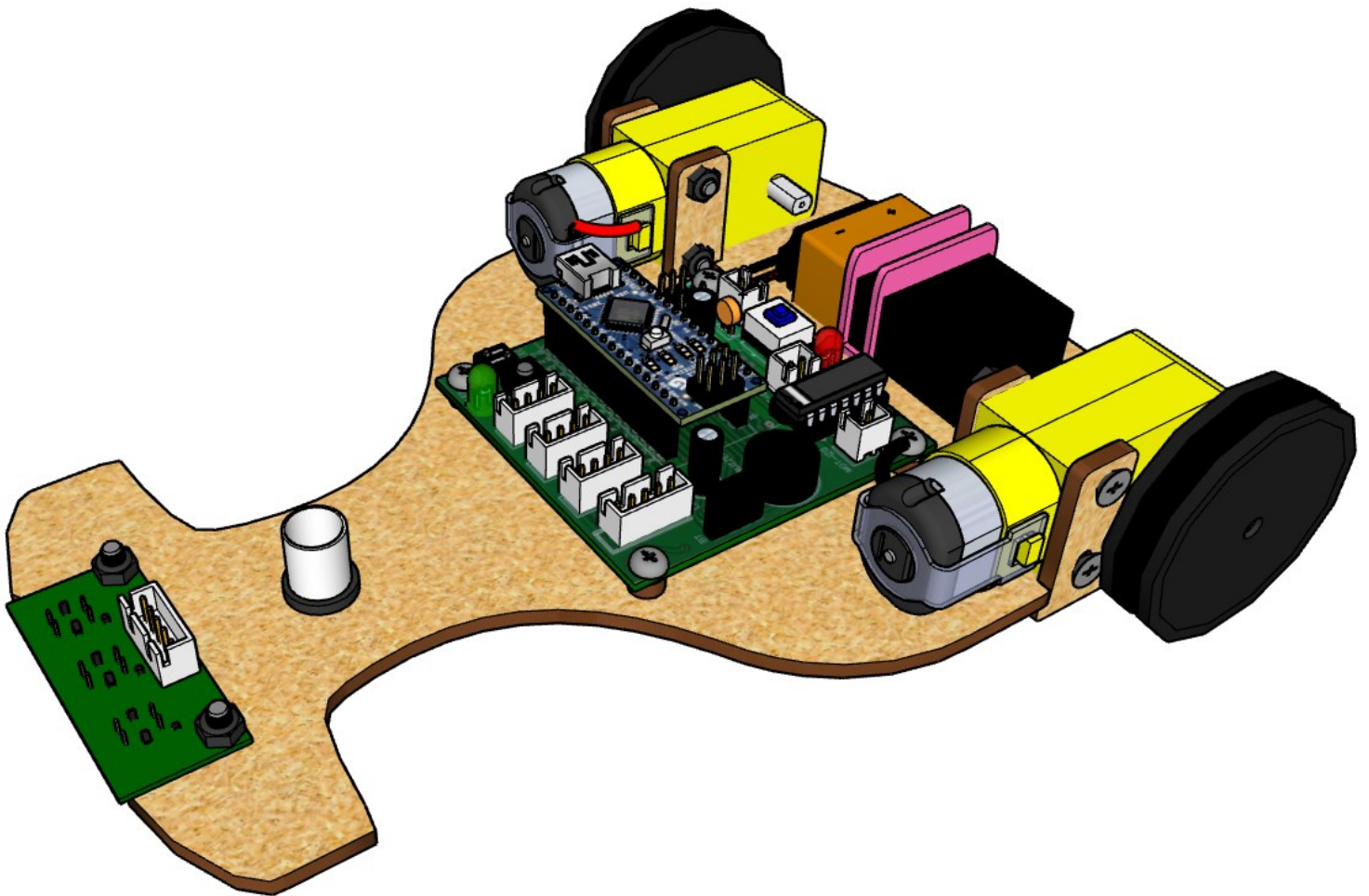

Para poder armar el **Seguidor de línea velocista V2** identifica las siguientes piezas.

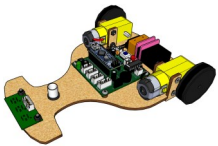
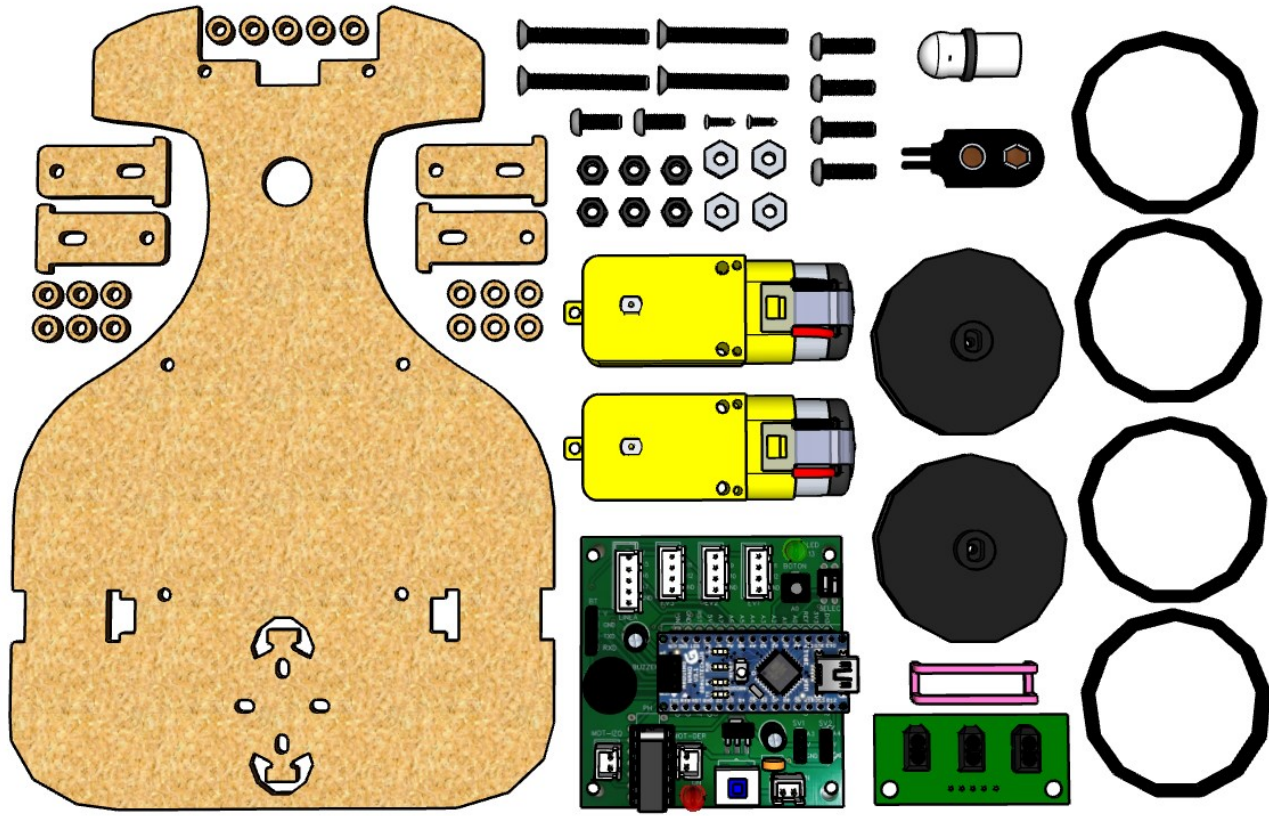

1



x1

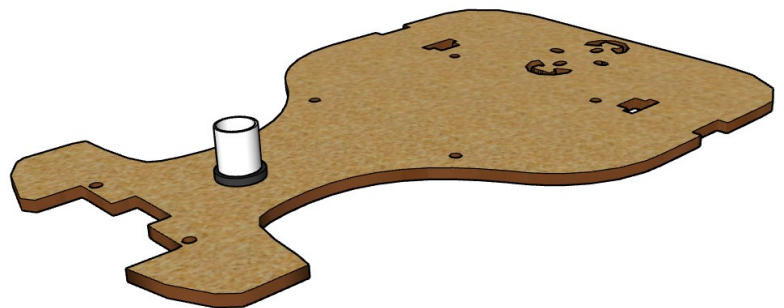
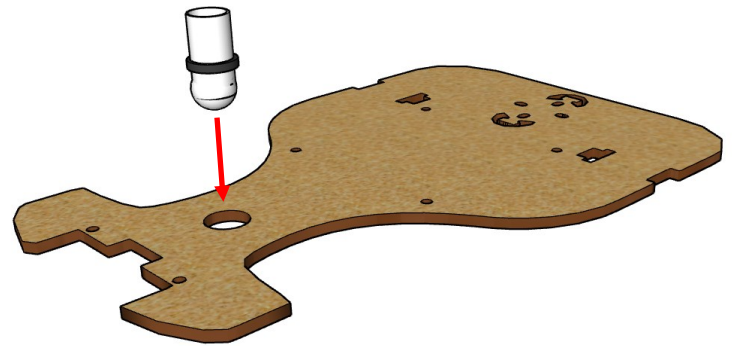

No se debe ejercer demasiada fuerza al colocar la rueda.

Si hay problemas para embonar se debe girar el chasis. Ya que solo entra en una dirección.

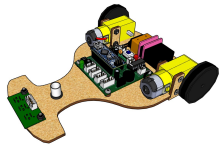

2

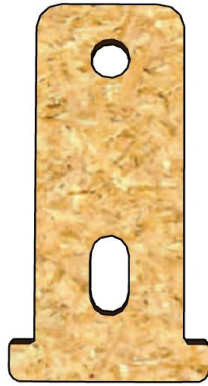

x2

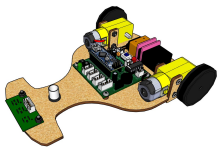
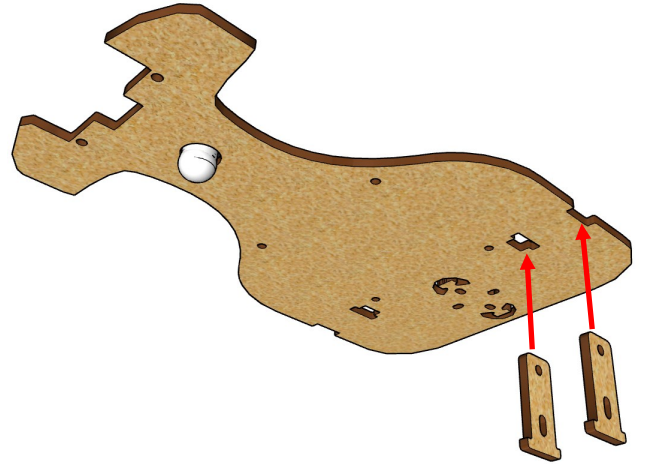

3

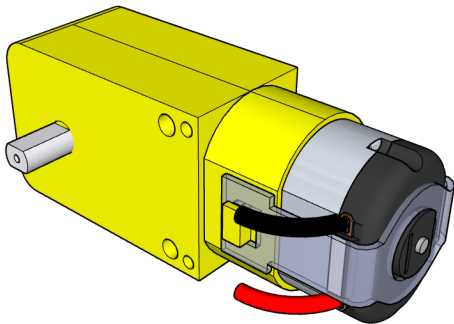

x1

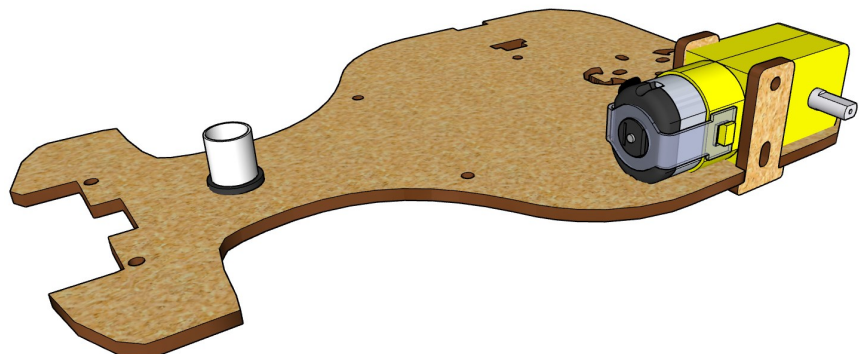
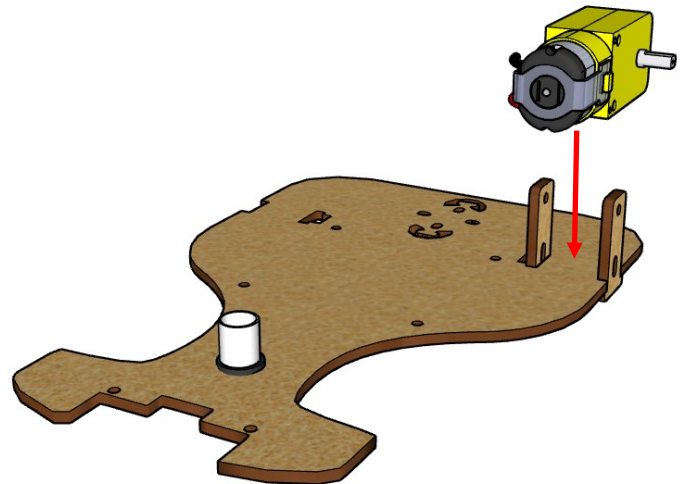

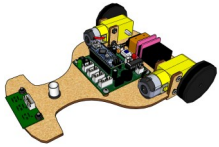

4

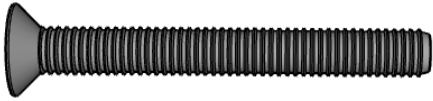

x2

Tornillo 3 cm

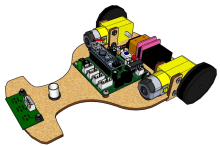
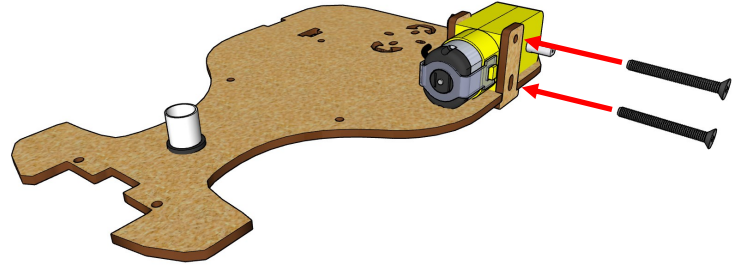

5



x2

Tuerca pequeña

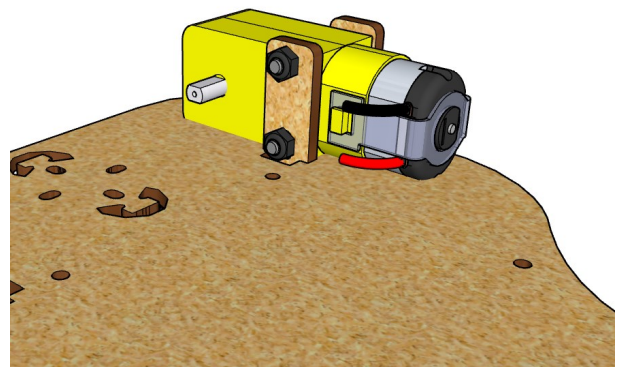
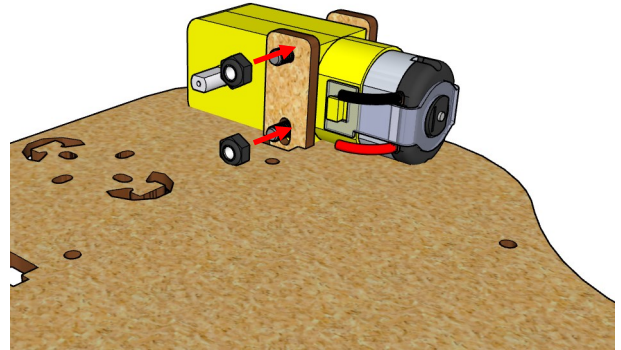
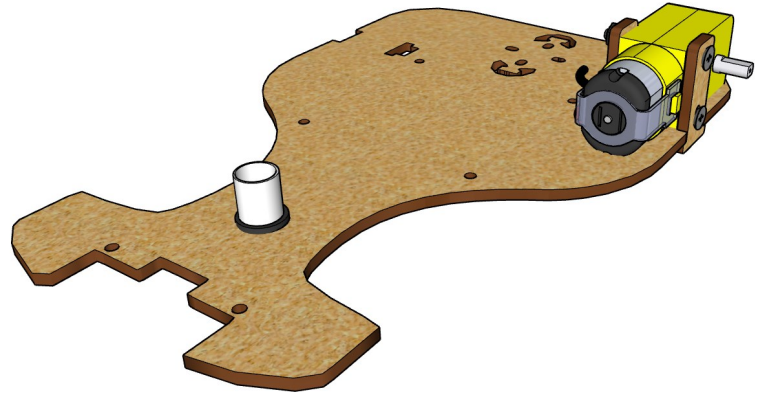

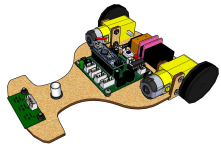

6

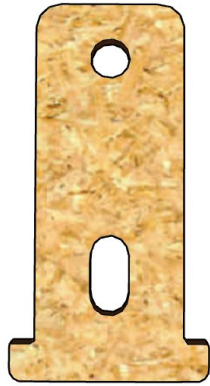

x2

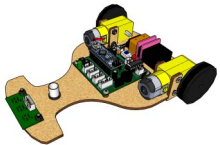
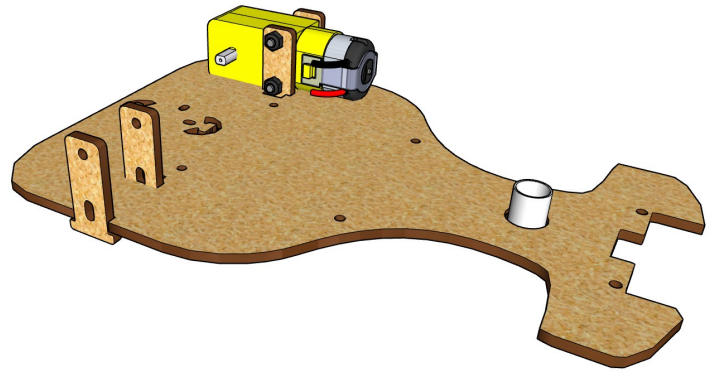
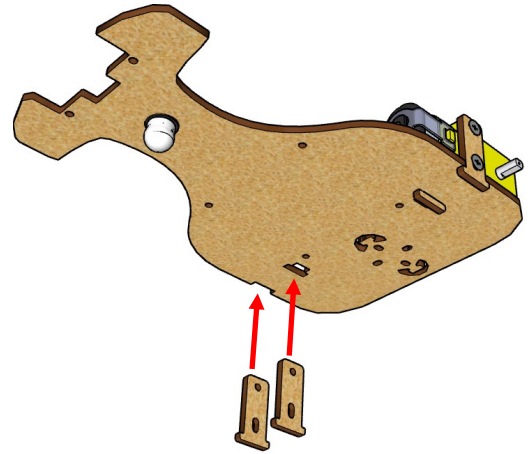

7

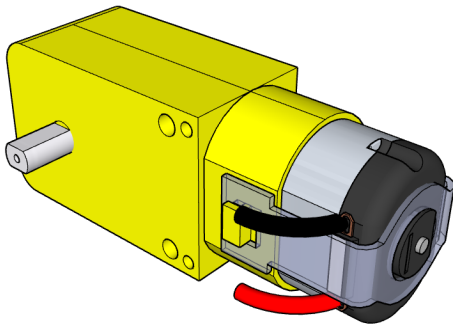

x1

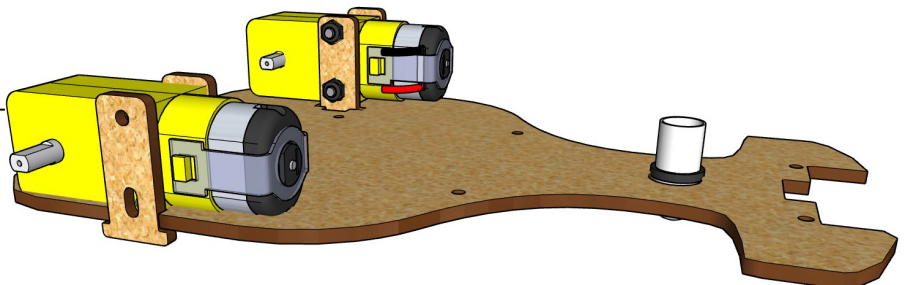
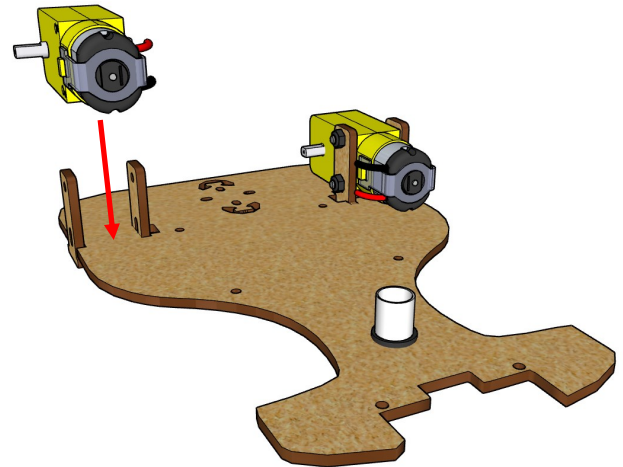

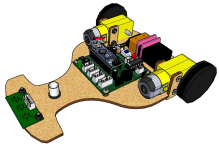

8

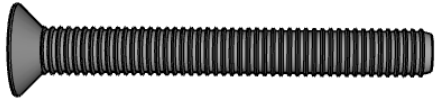

x2

Tornillo 3 cm

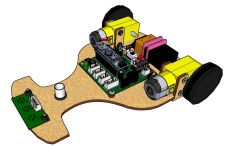
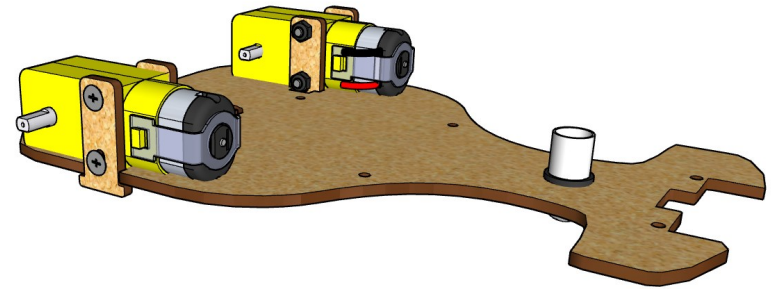
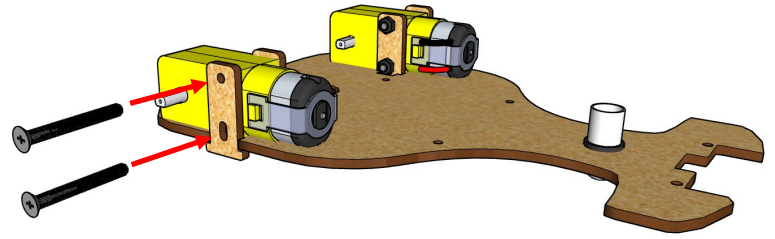

9

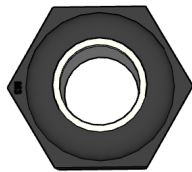

x2

Tuerca pequeña

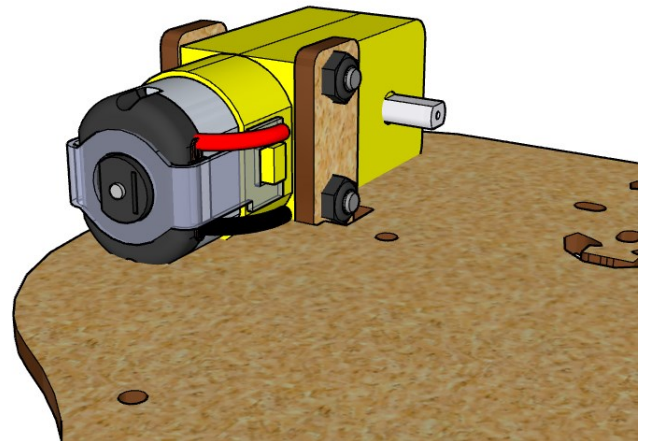
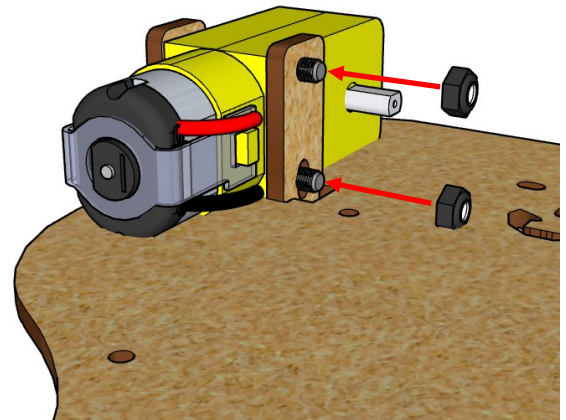

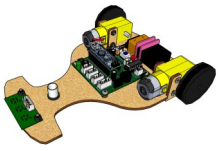

10



x4

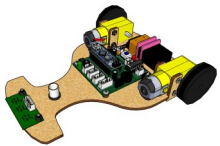
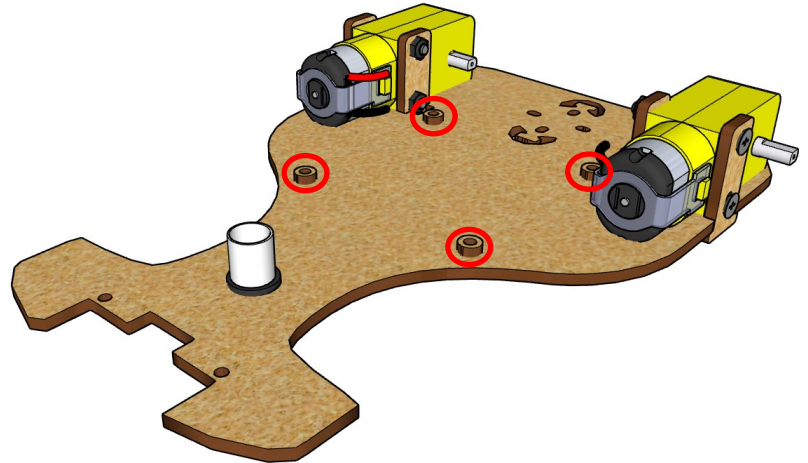
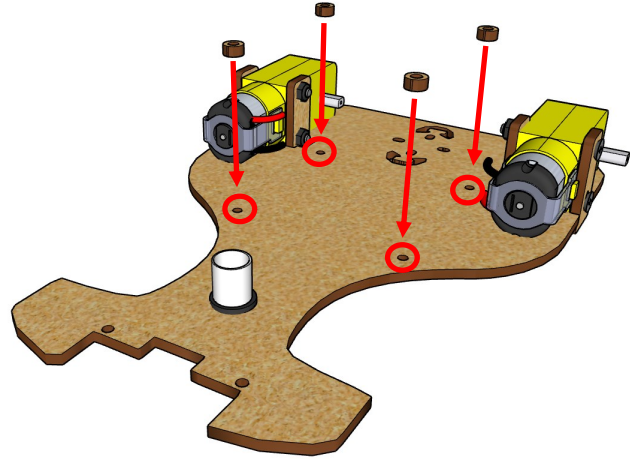

11

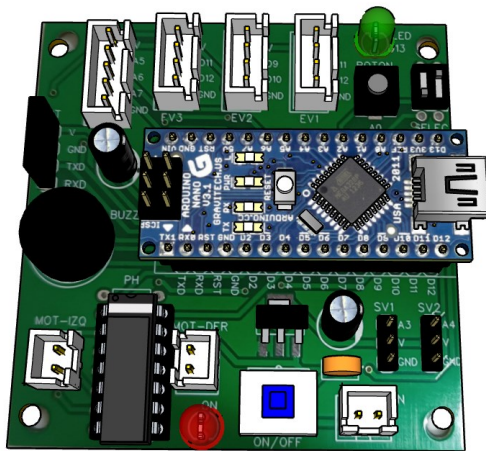

x1

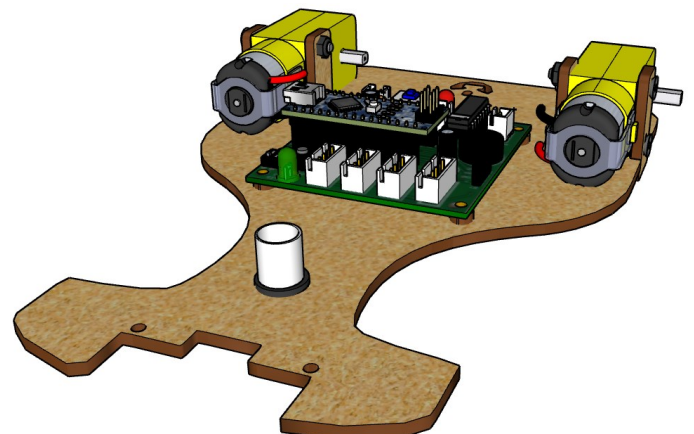
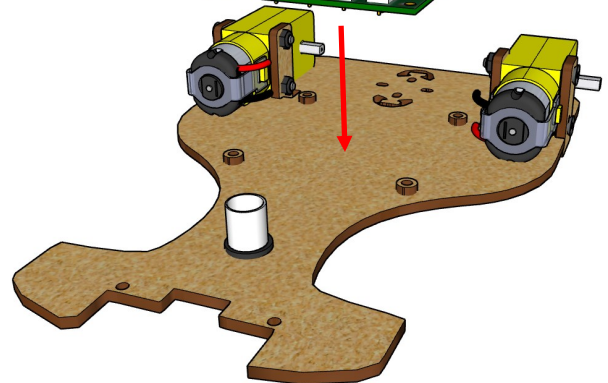
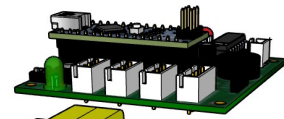

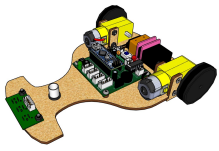

12

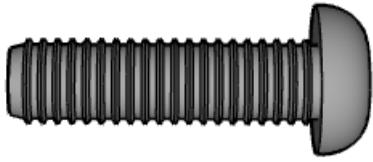

x4

Tornillo 1.5 cm

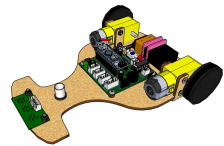
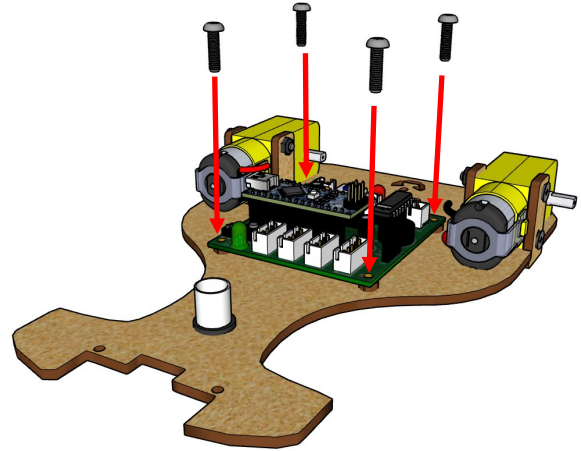

13

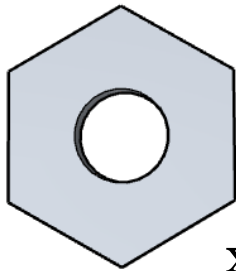

x4

Tuerca grande

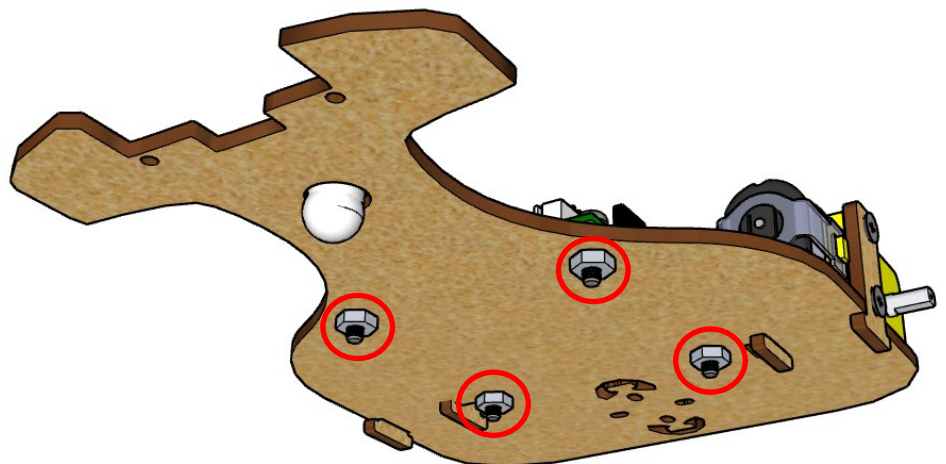
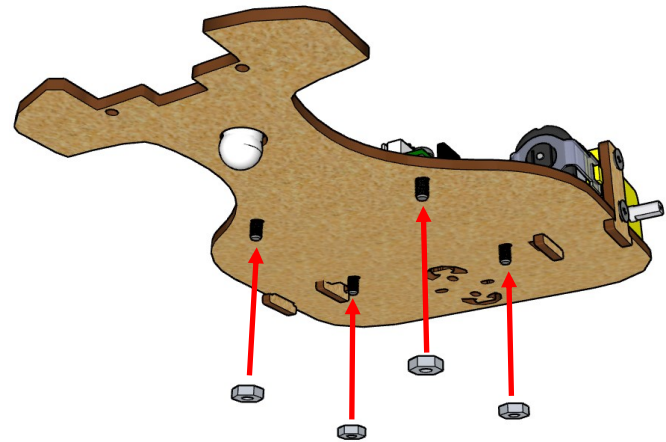

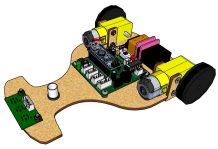

14

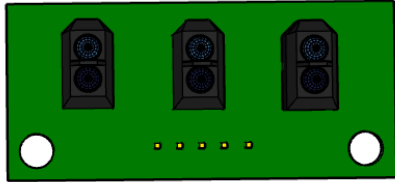

x1

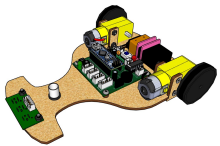
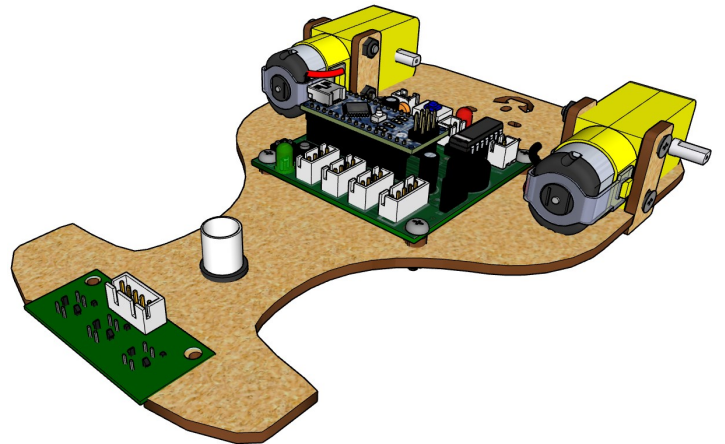
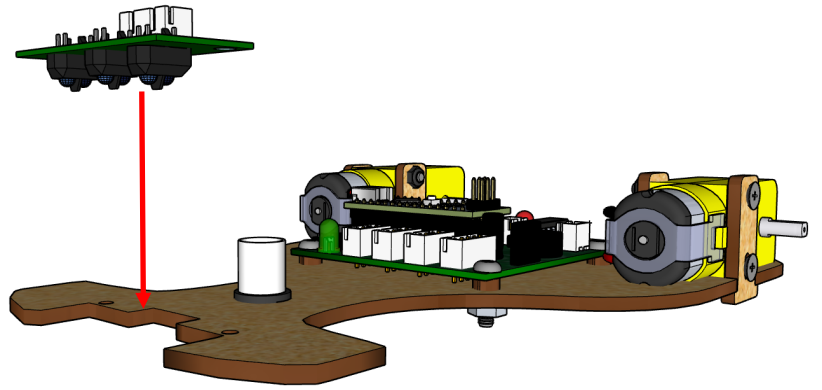

15



Tornillo 1.2 cm

x2

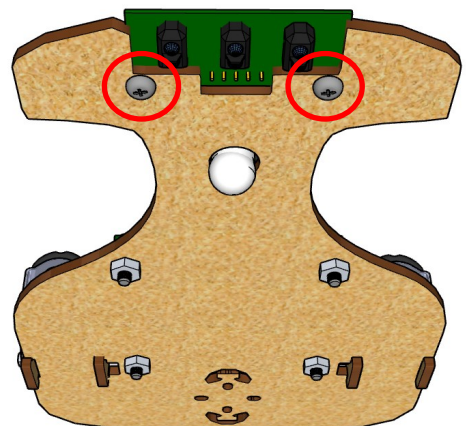
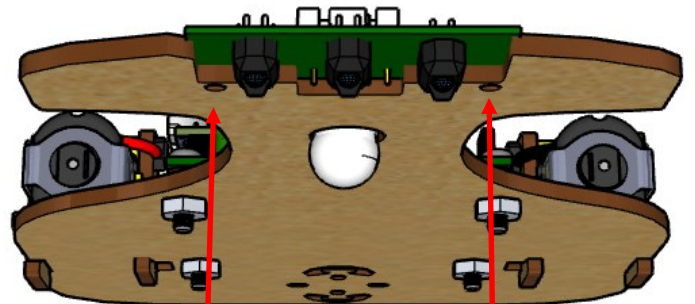

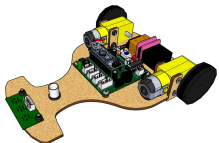

16



x2

Tuerca pequeña

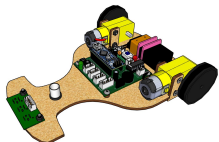
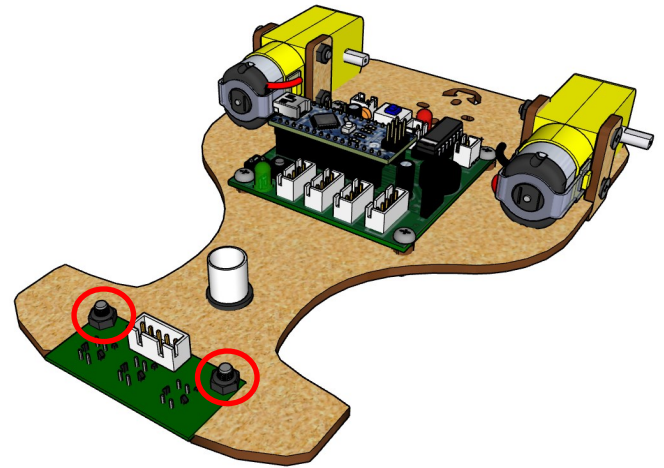
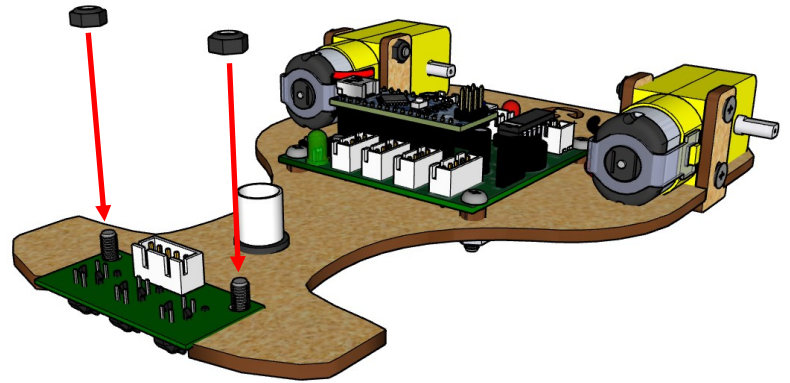

17

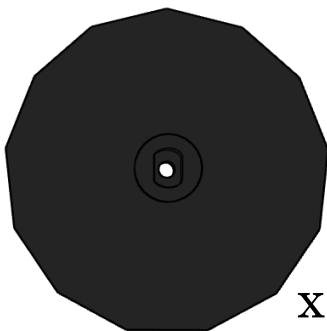

x1

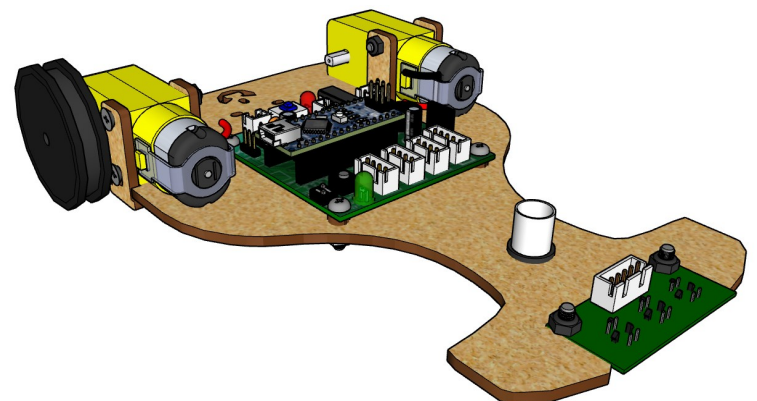
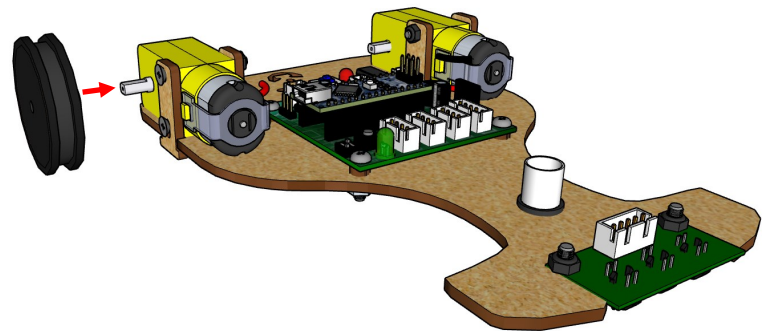

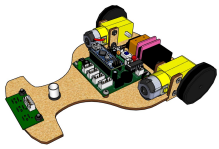

18

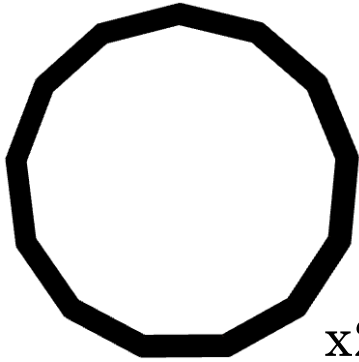

x2

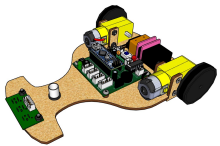
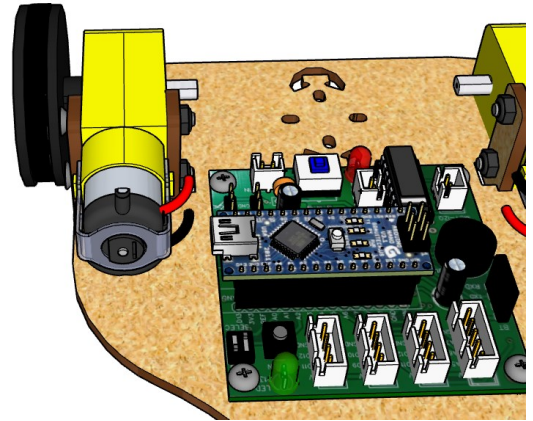
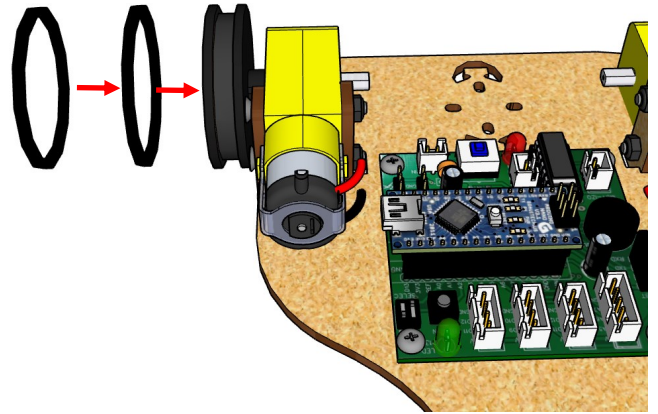

19

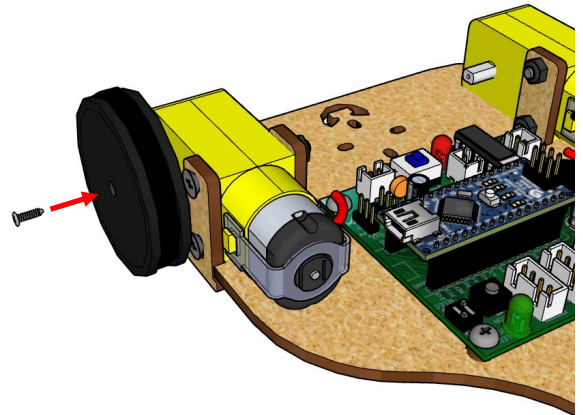

x1

Tornillo 1 cm

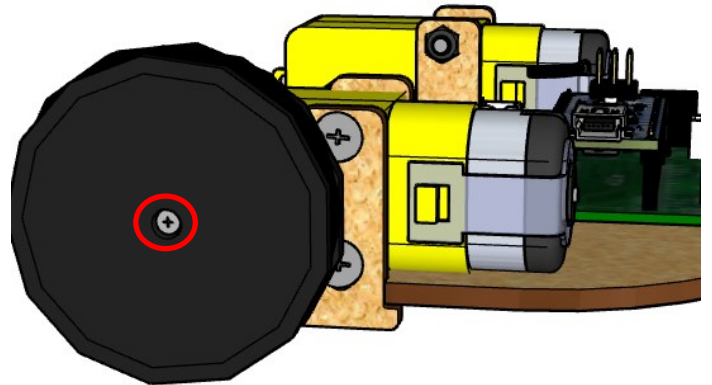

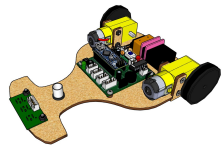

20

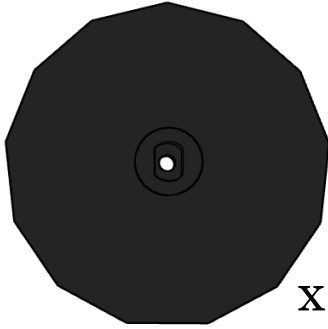

x1

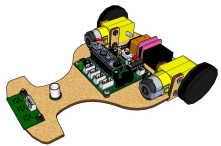
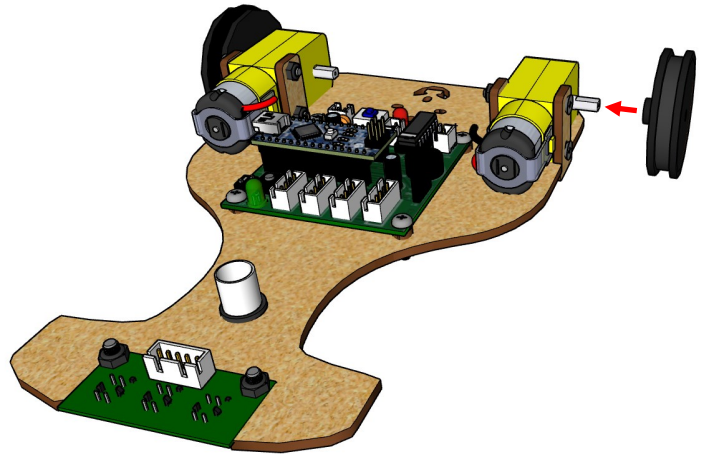

21

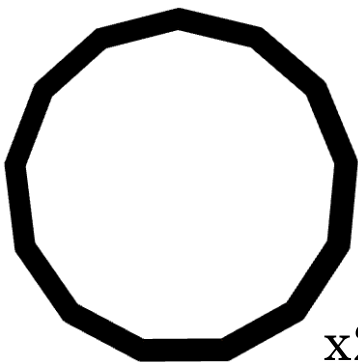

x2

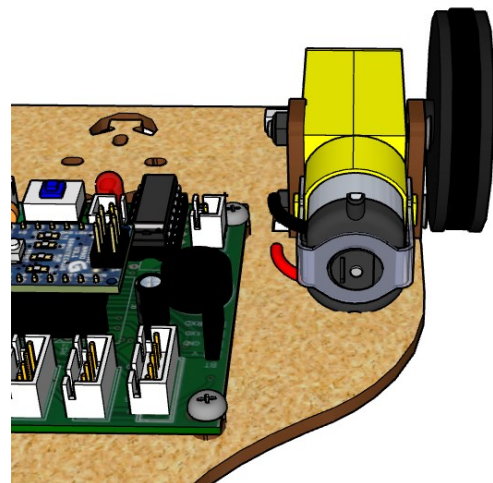
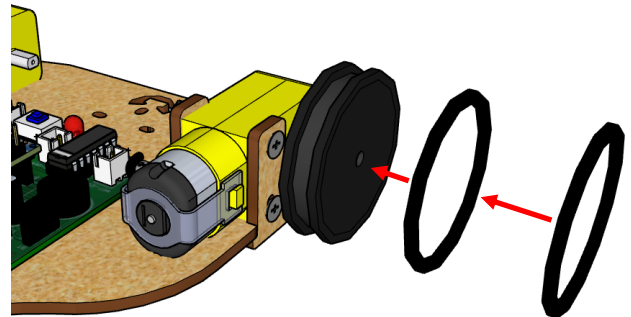
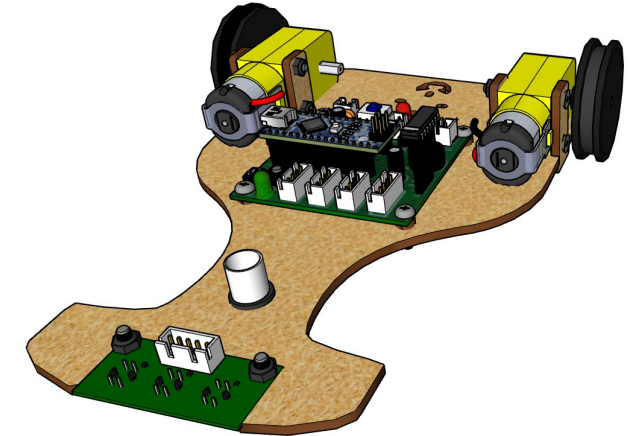

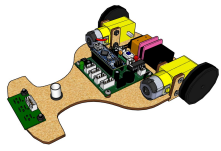

22

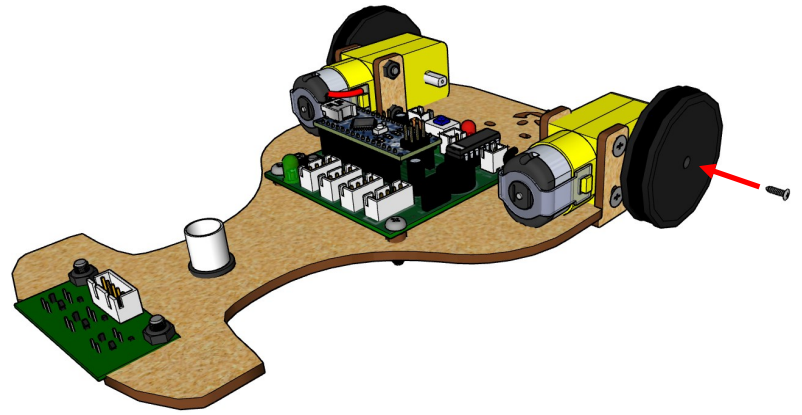

x1

Tornillo 1 cm

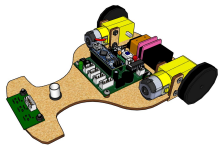
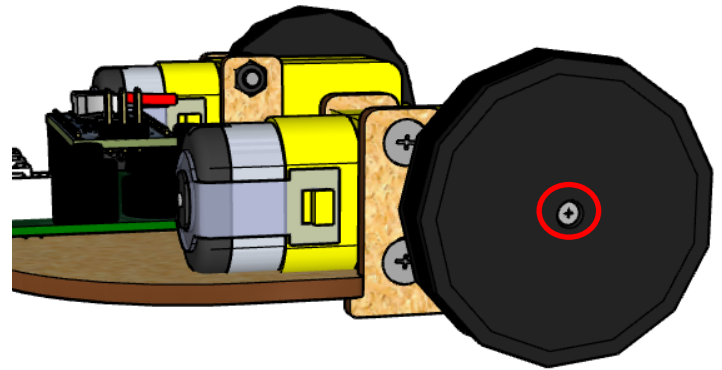

23

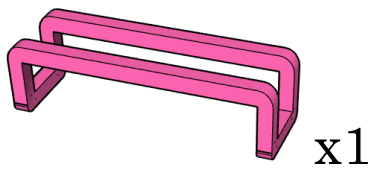
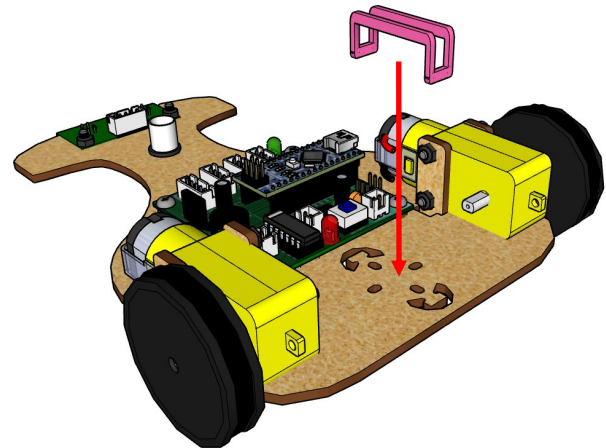

x1

Liga de goma

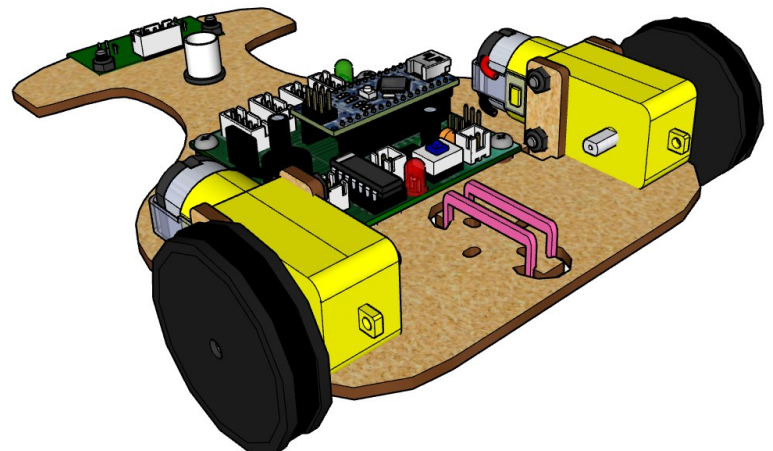

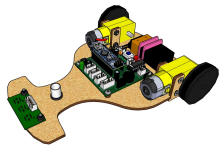

24

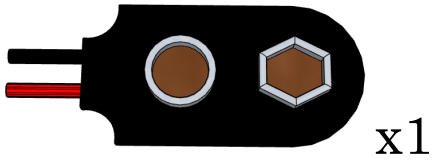

x1

Broche para batería 9v.

Batería no incluida.

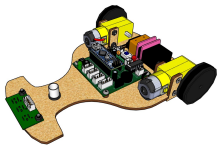
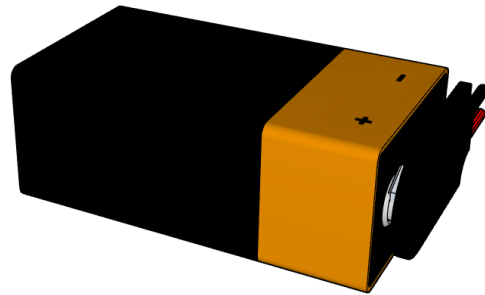
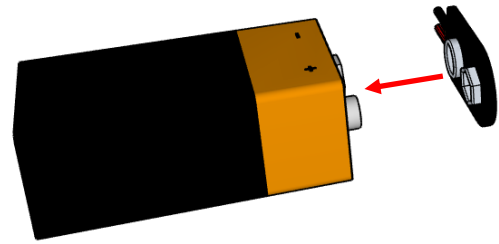

25

Utiliza la liga de goma para fijar la batería 9v.

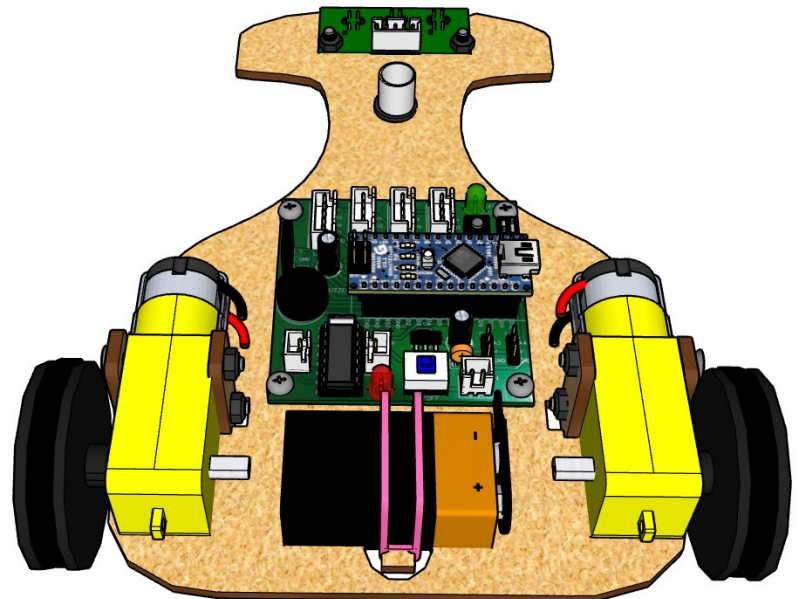

Tornillería

Utiliza el siguiente esquema para comparar y conocer las medidas de los tornillos y tuercas que necesitas durante el ensamble. Solo basta con colocar encima el tornillo o tuerca hasta que coincida con alguna de las figuras. (Para corroborar correctamente las medidas de los tornillos imprime esta hoja)

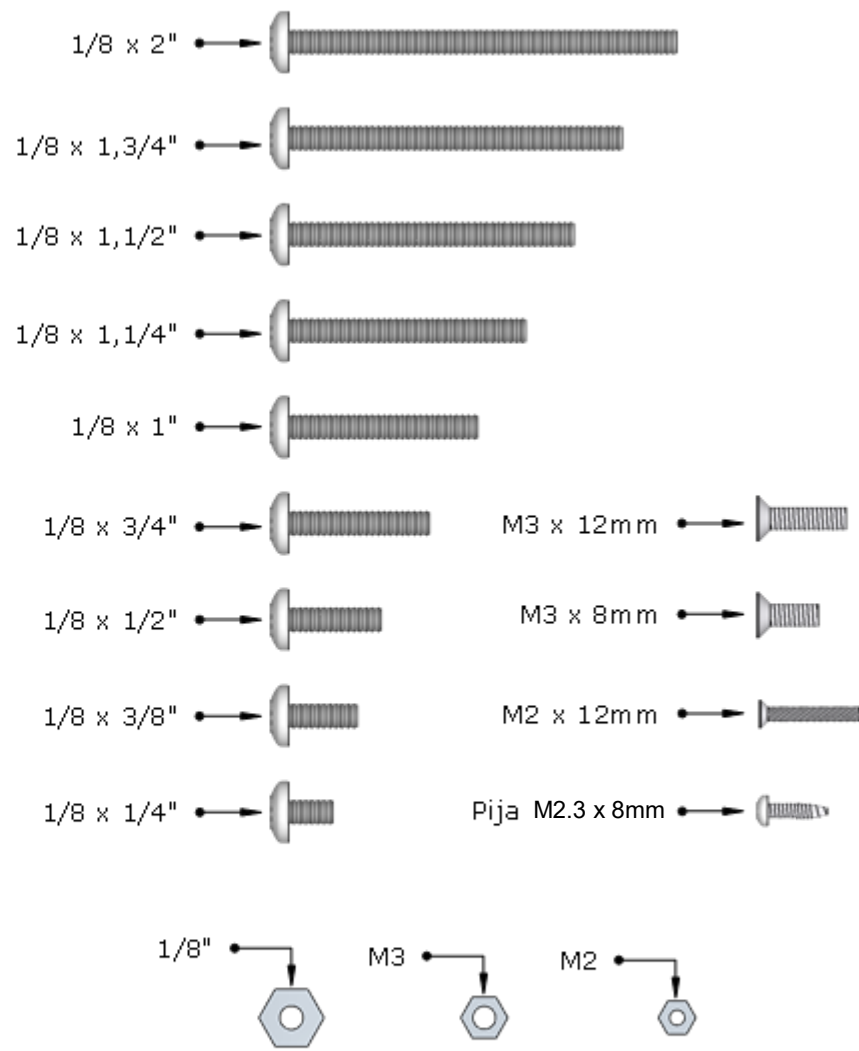

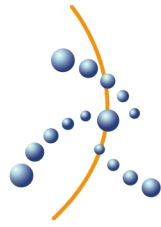

robodacta.mx
robótica didáctica

No te olvides visitar nuestro sitio web y seguirnos en nuestras redes sociales donde encontrarás más contenido.

www.robodacta.mx



@Robodacta.RD



56 396 6 1716



@robodacta.mx



RobodactaMx