

robodacta.mx
robótica didáctica

Manual de ensamble
Kit Sumo Alámbrico
Código KIT1425

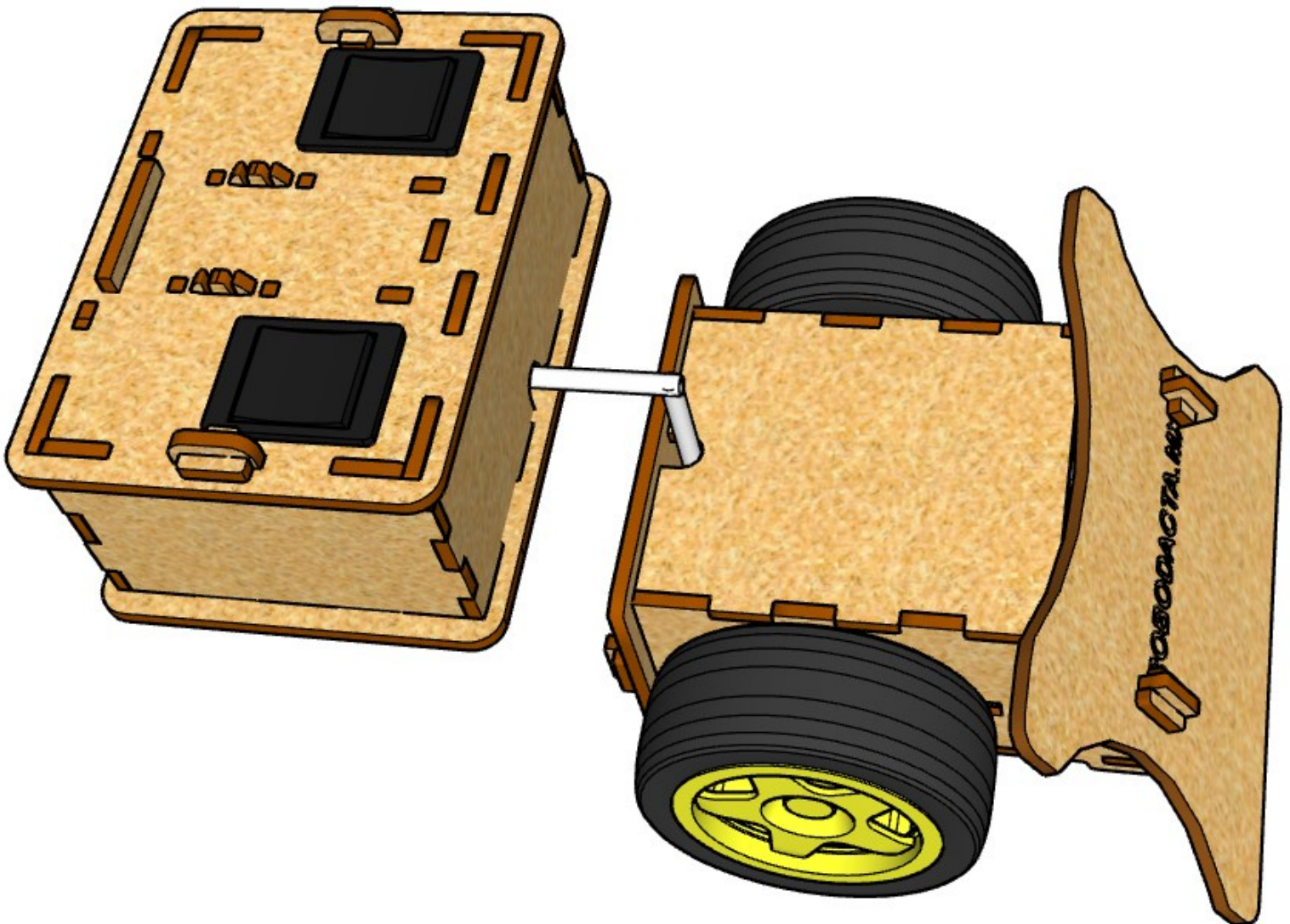

Para poder armar el **Robot Sumo** identifica las siguientes piezas.

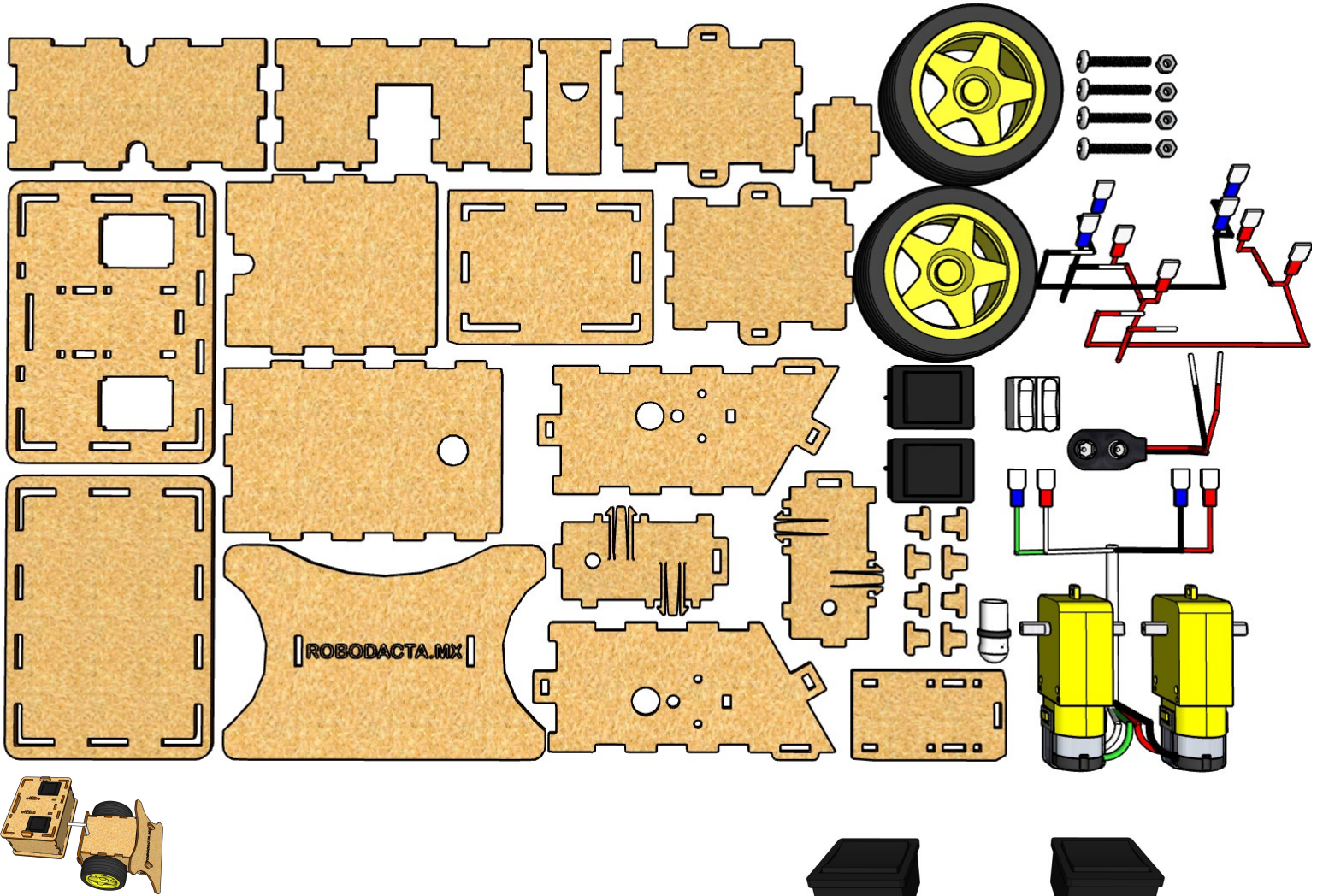

1

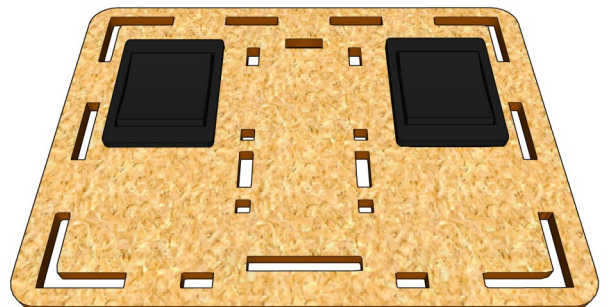
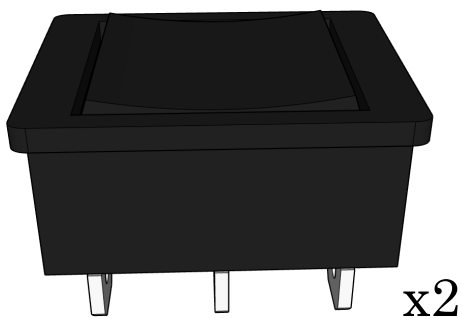
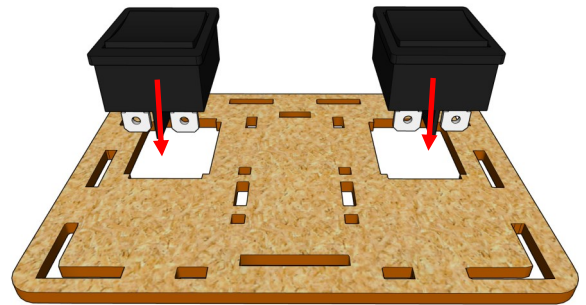
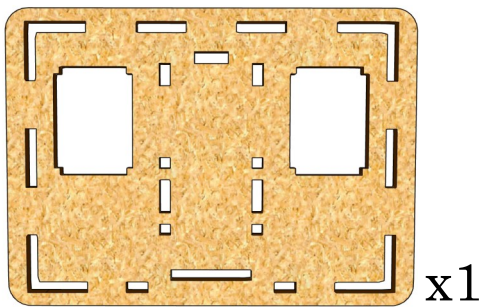

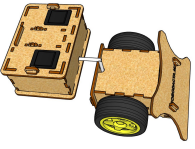

2

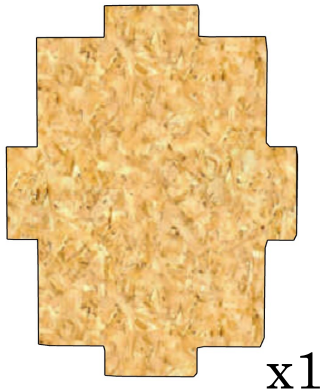

x1

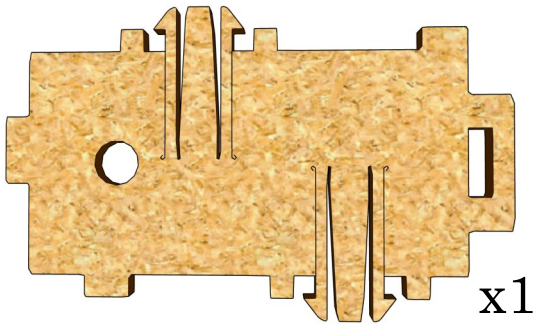
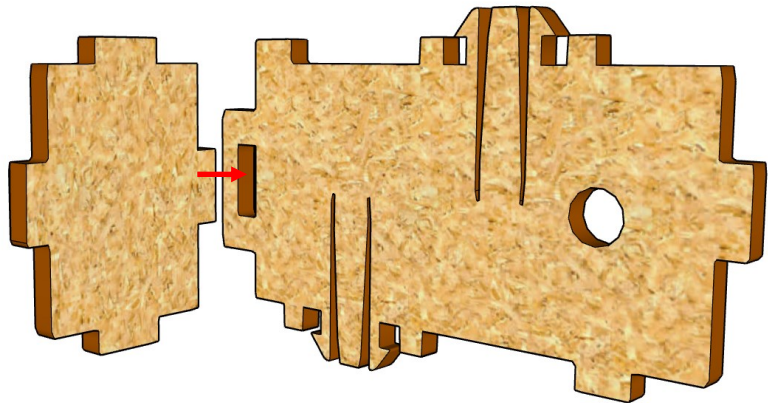

x1

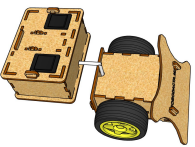
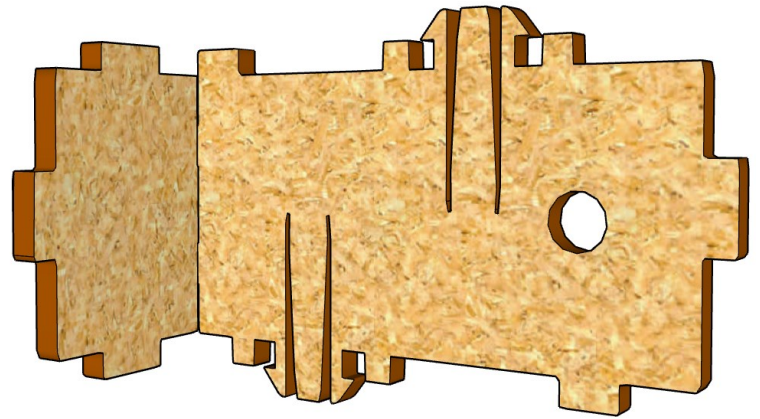

3

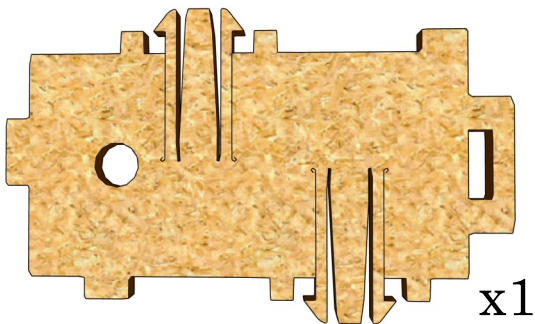

x1

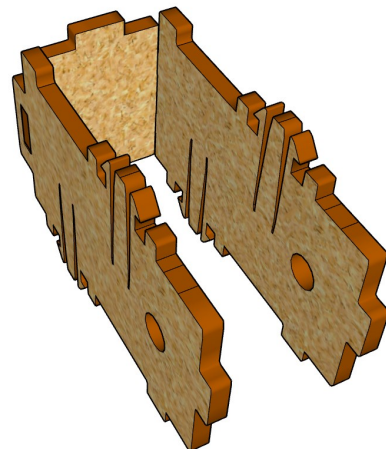
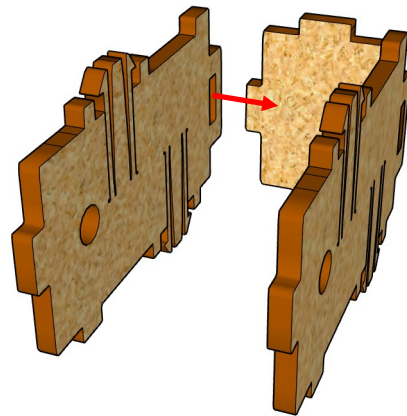

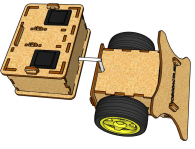

4

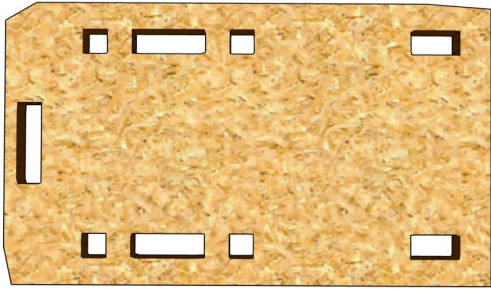

x1

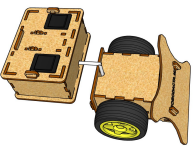
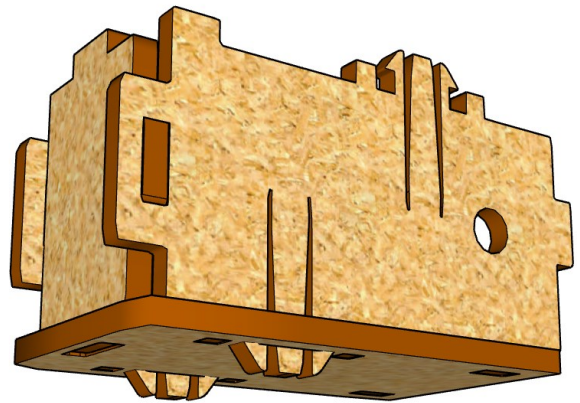
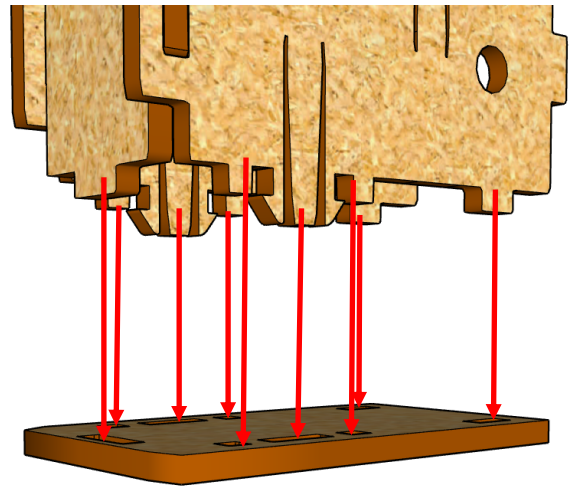

5

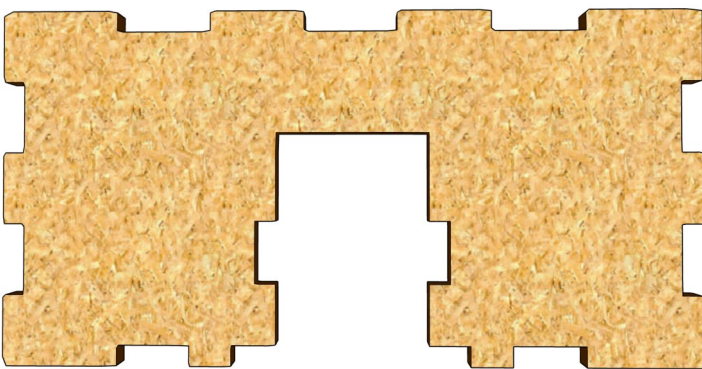

x1

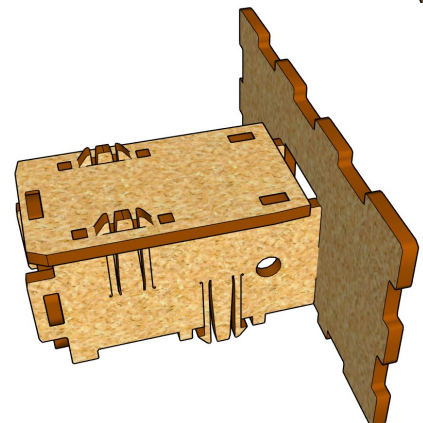
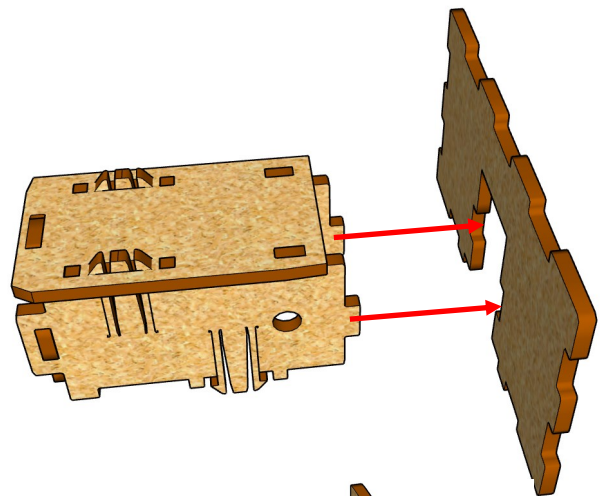

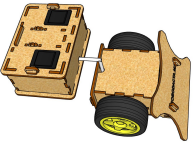

6

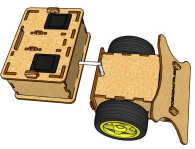
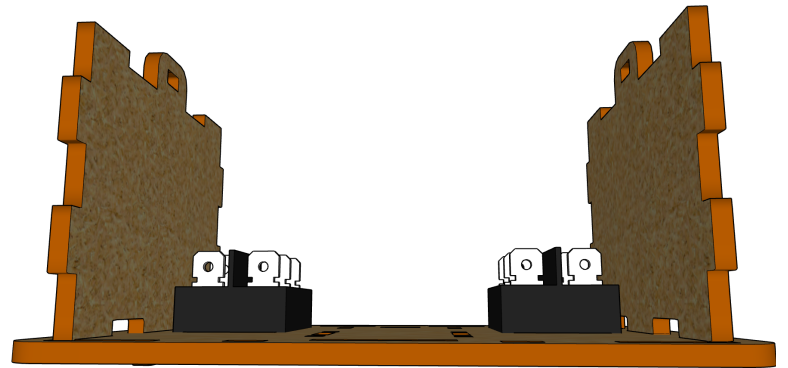
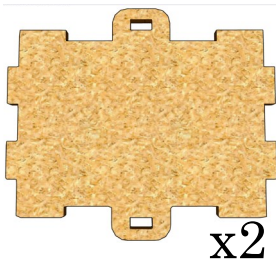
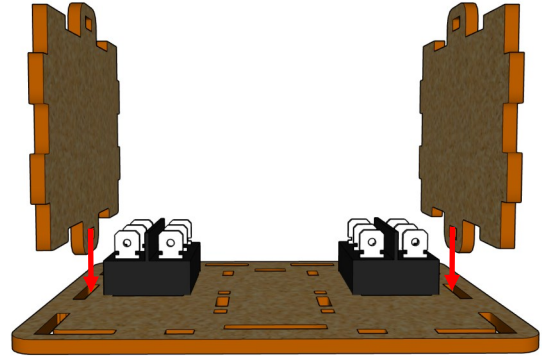
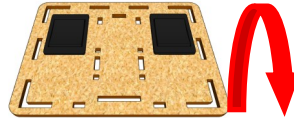
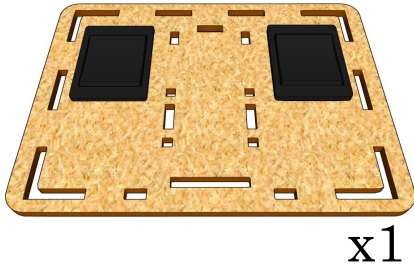

7

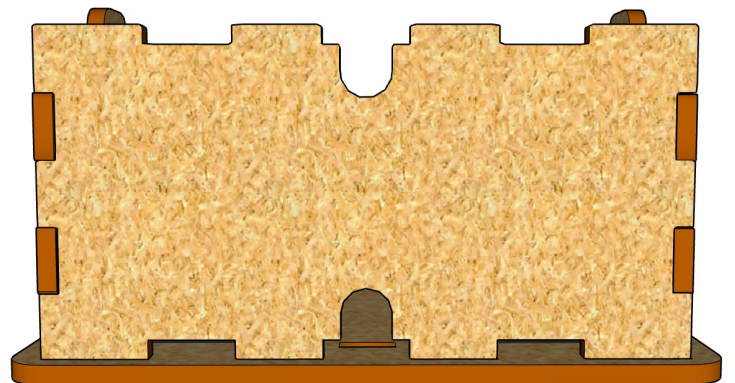
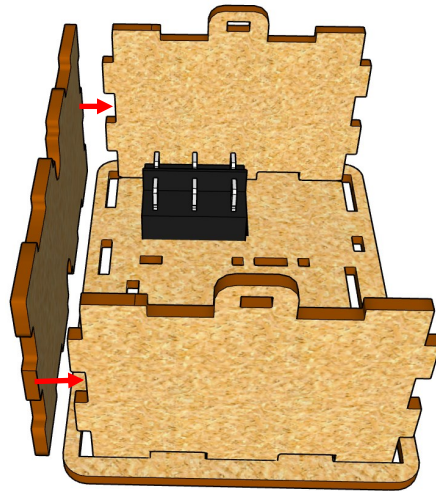
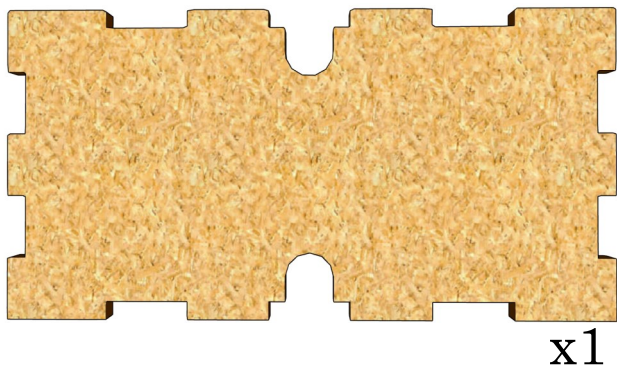

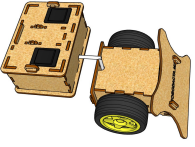

8

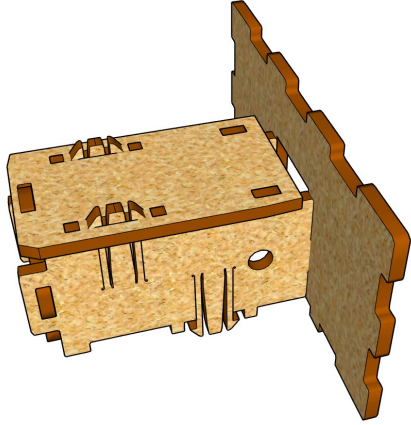

x1

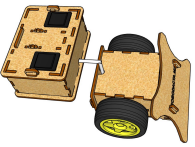
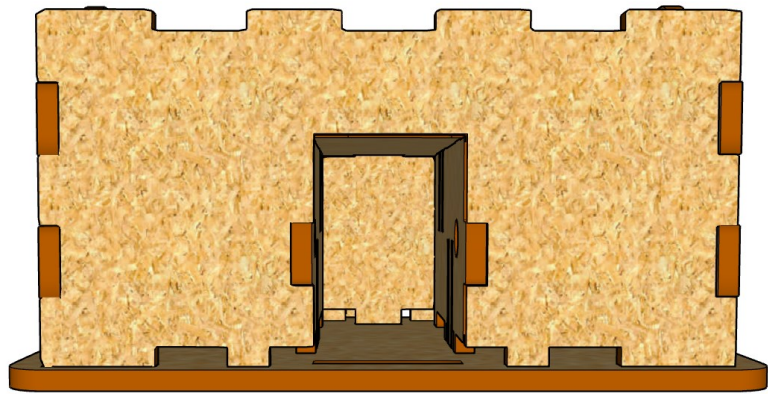
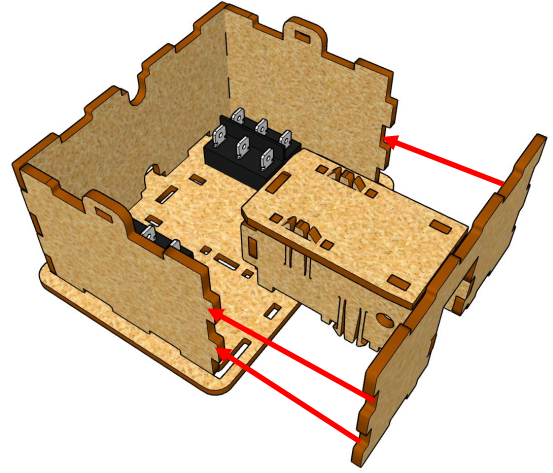

9

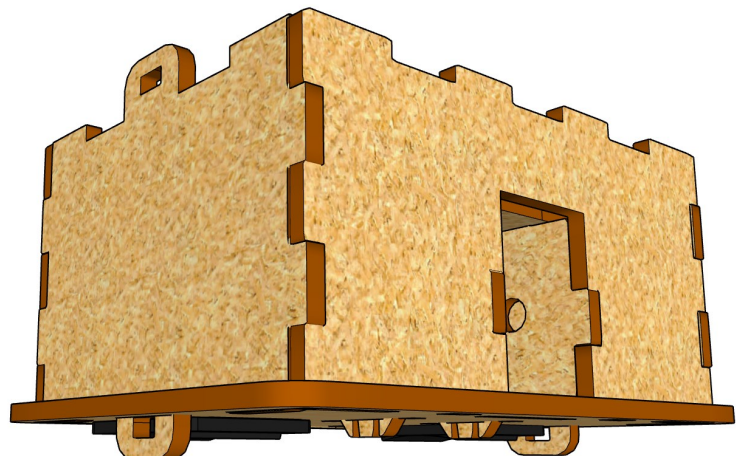
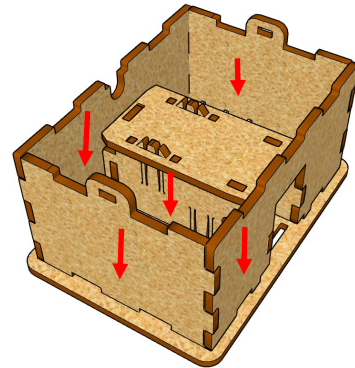

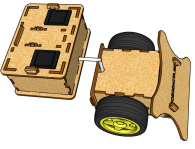

10

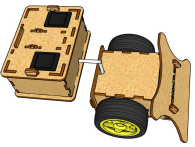
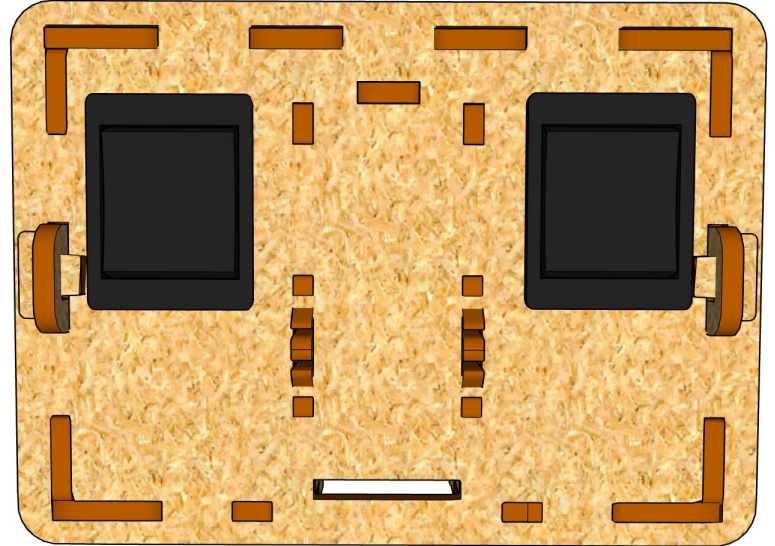
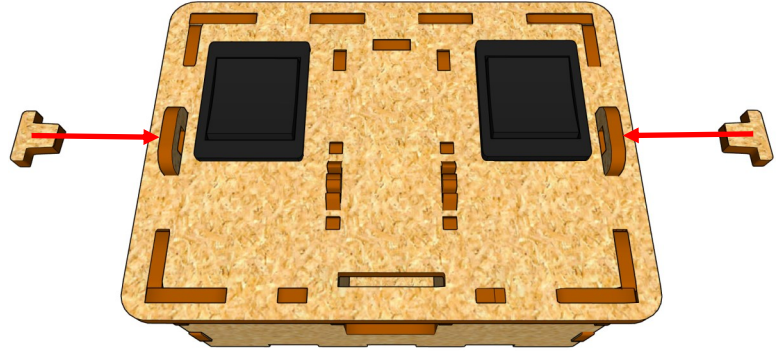
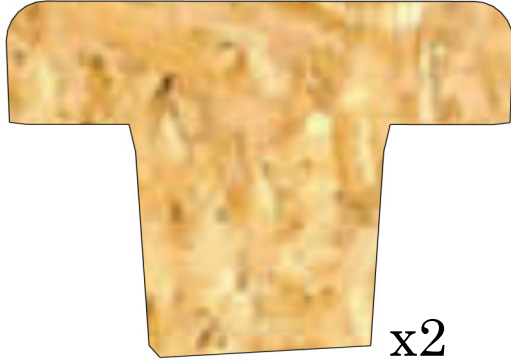

11

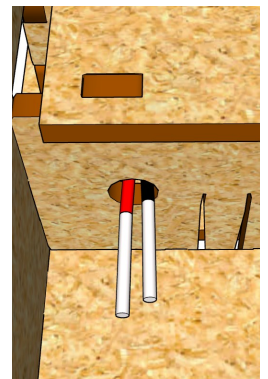
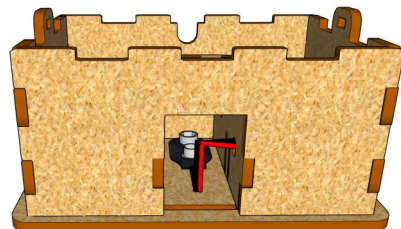
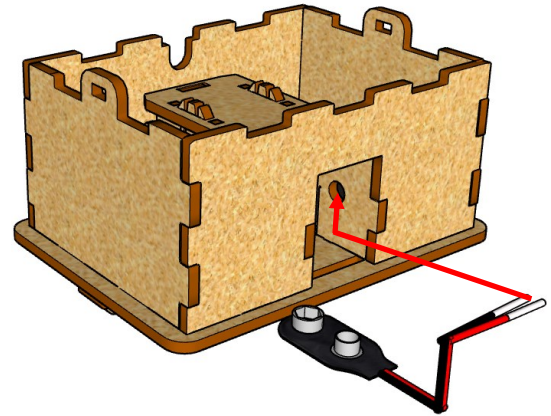

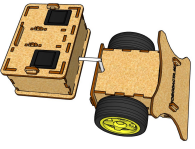

12

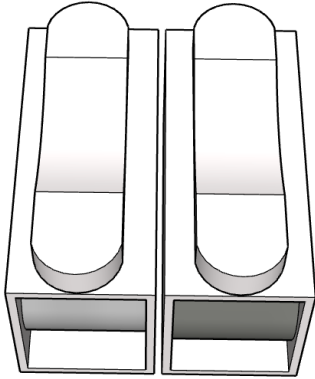

x1

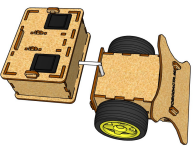
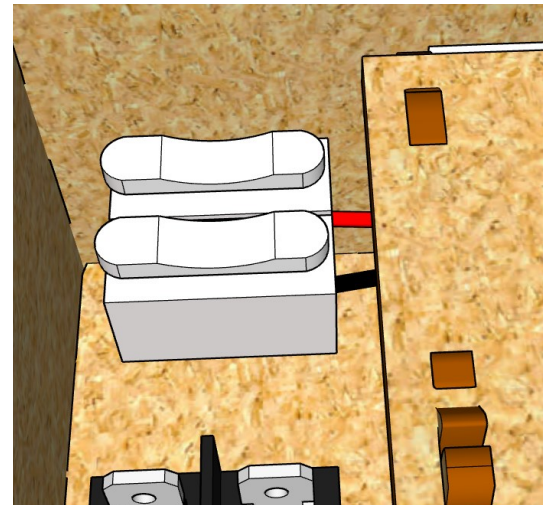
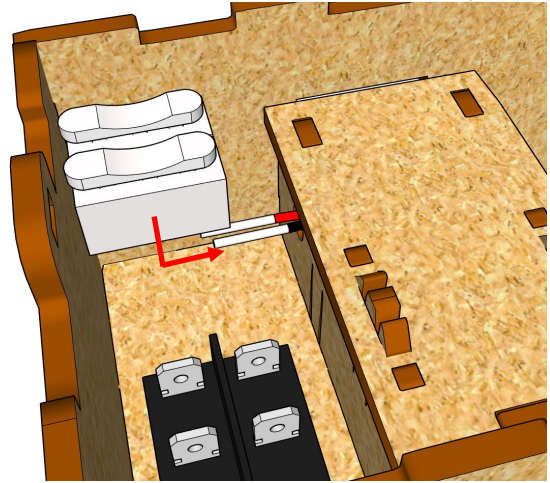

13

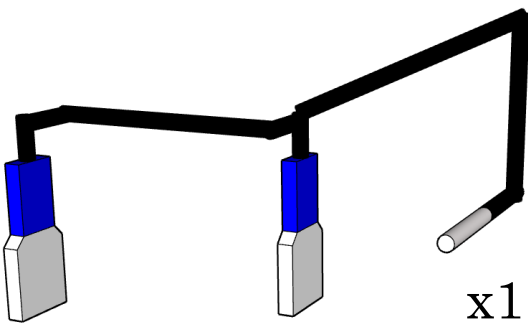

x1

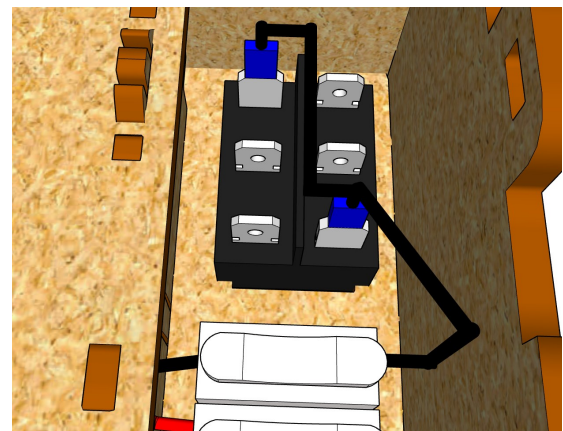
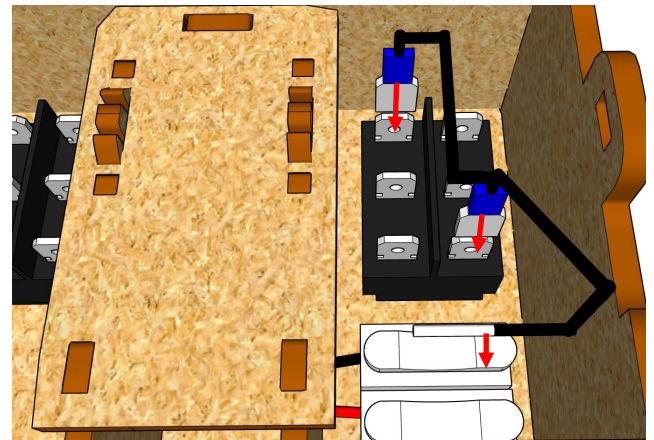

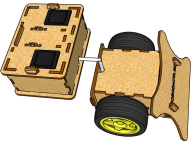

14

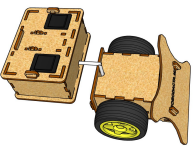
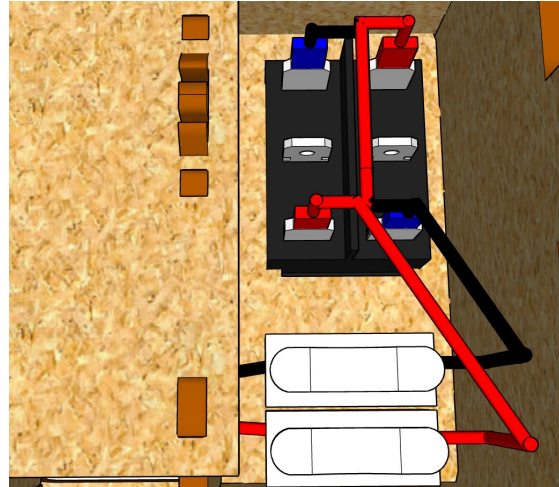
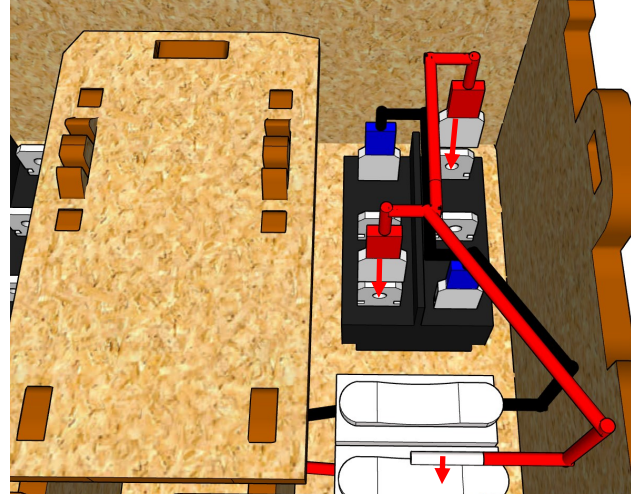
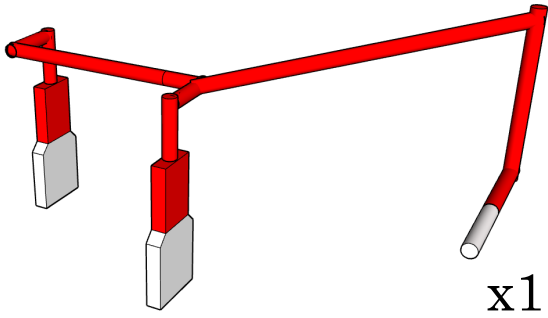

15

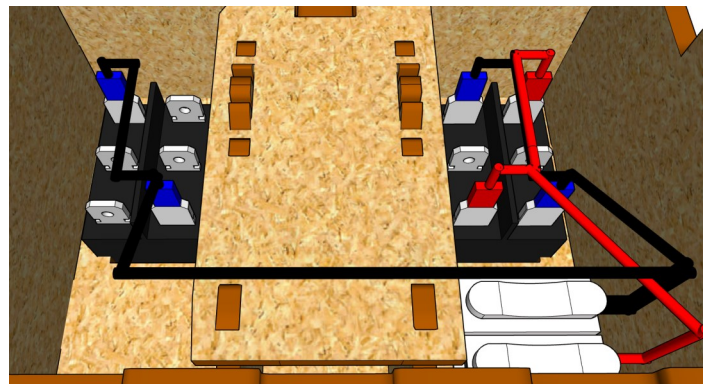
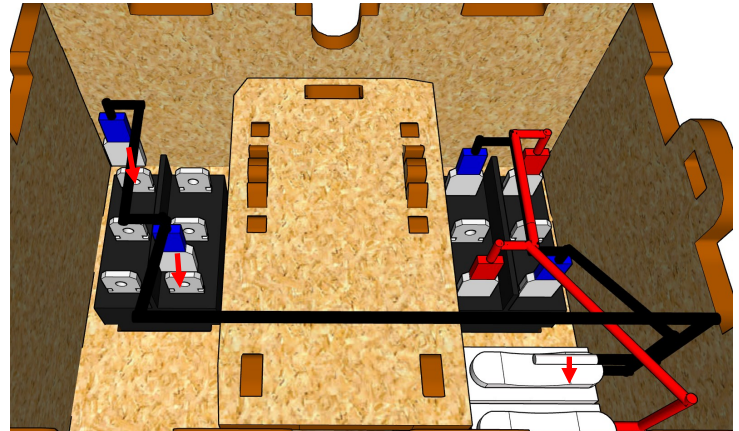
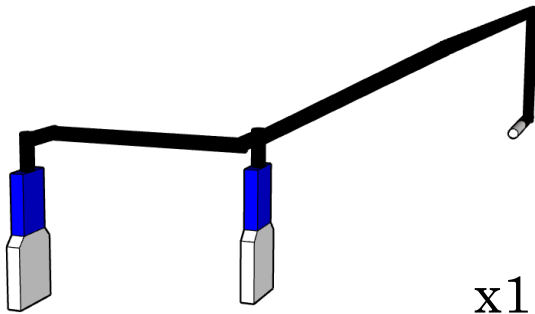

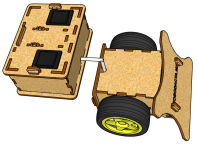

16

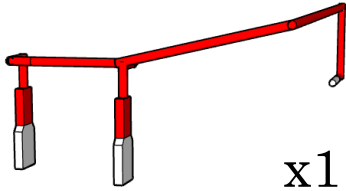

x1

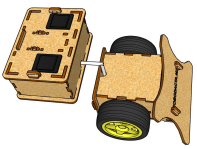
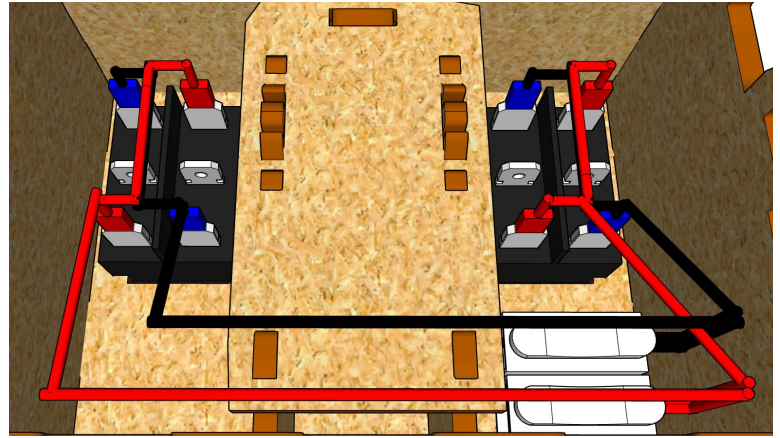
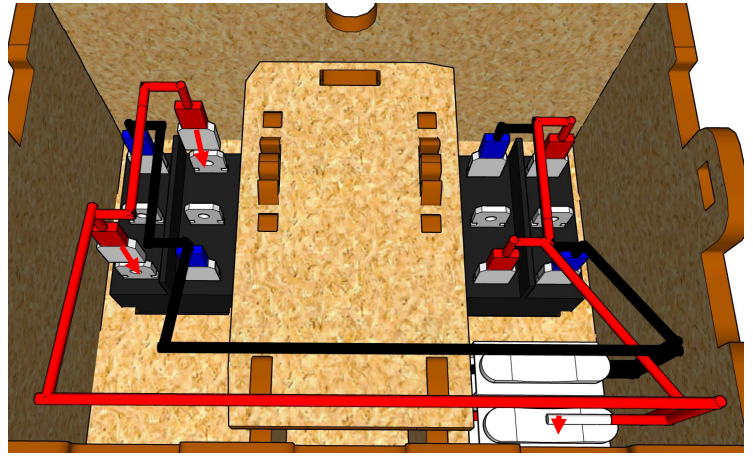

17

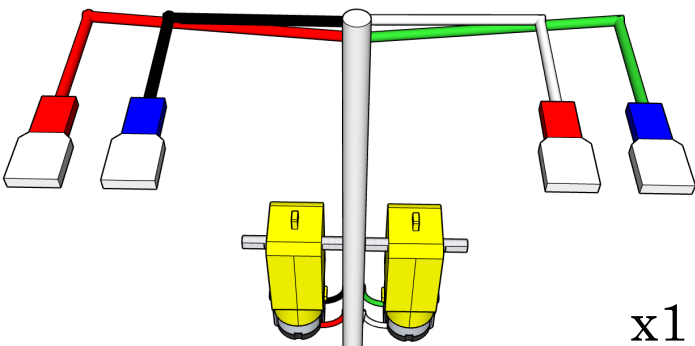

x1

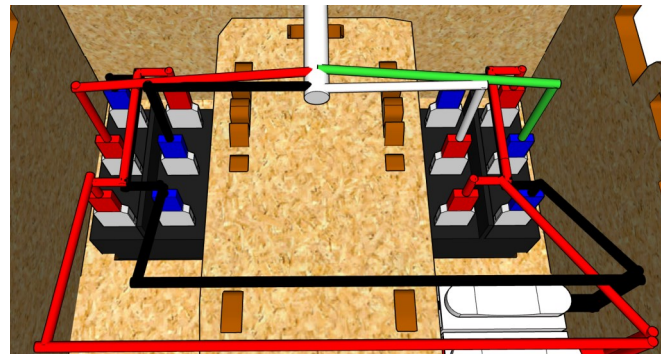
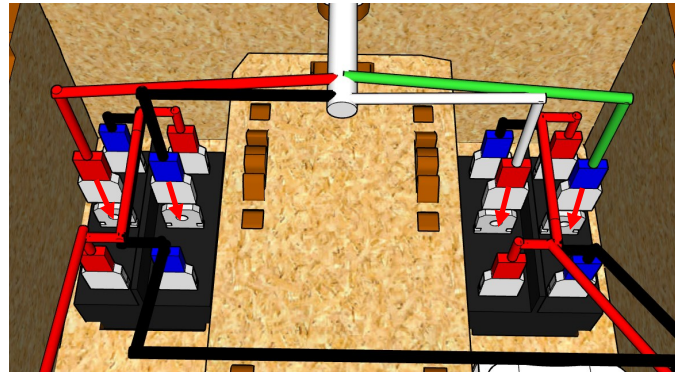

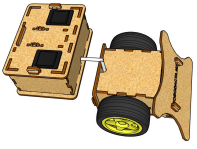

18

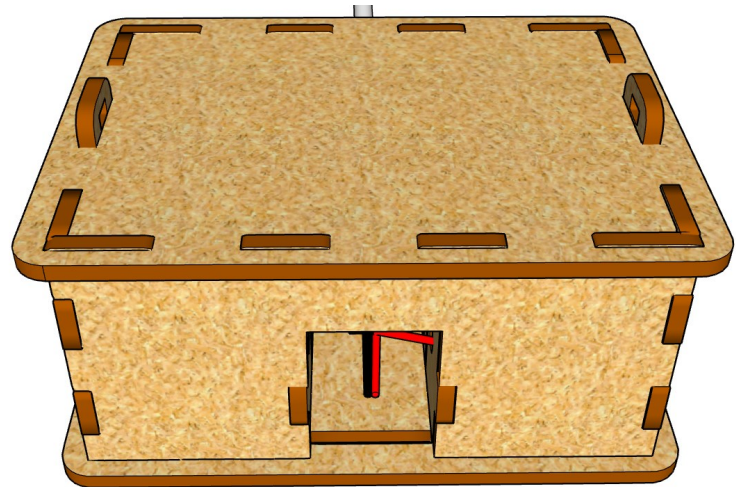
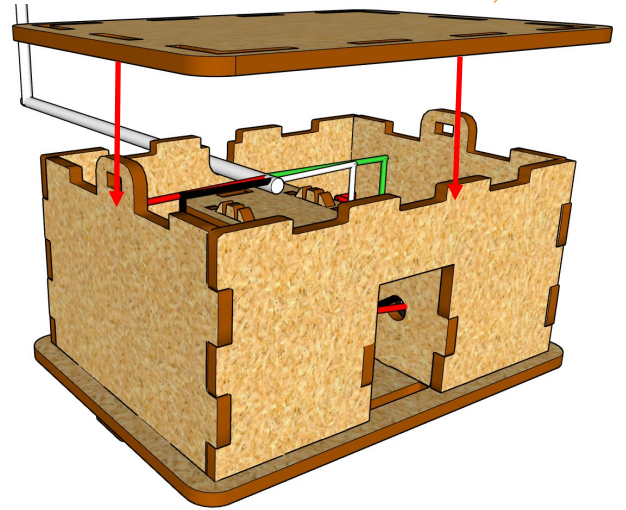
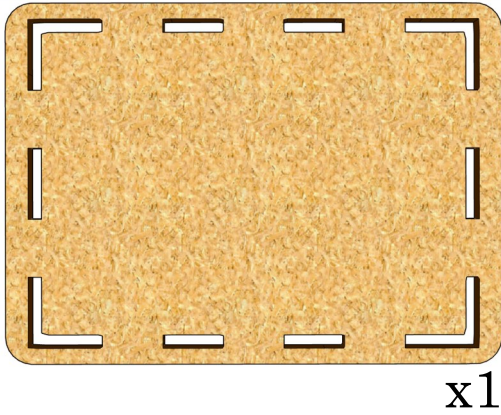

Nota: Los cinturones de seguridad deben quedar dentro del control.

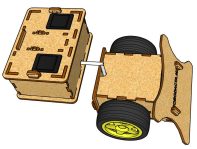

19

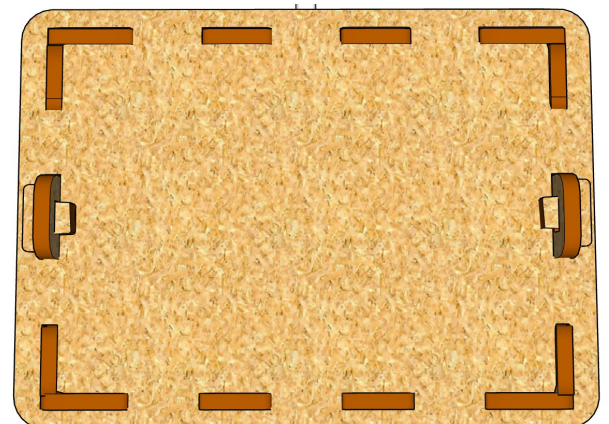
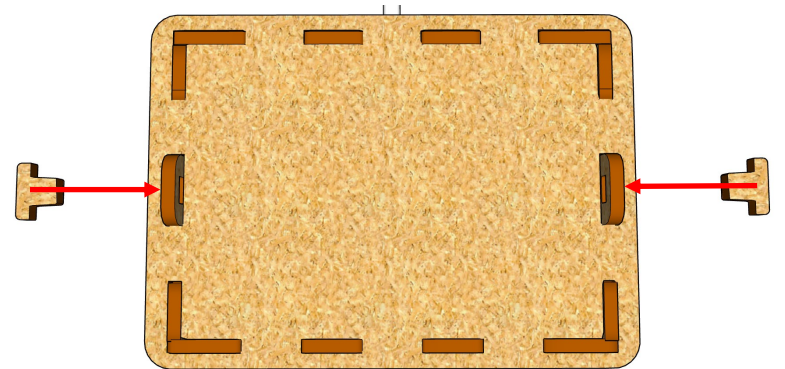

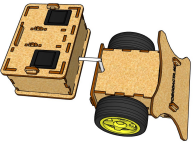

20

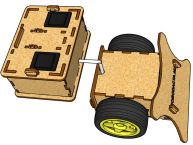
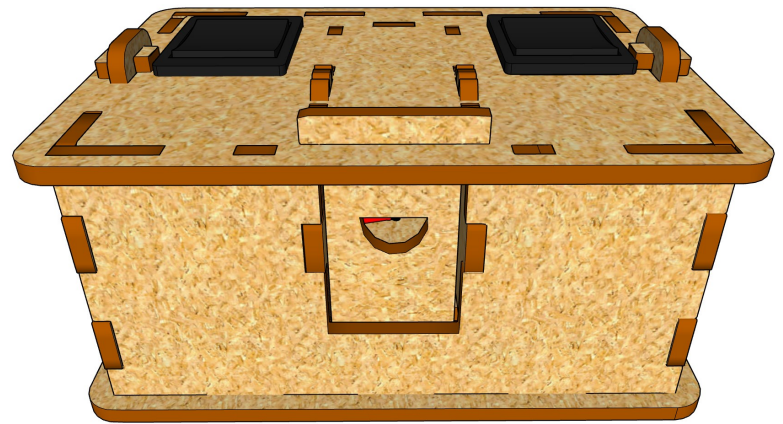
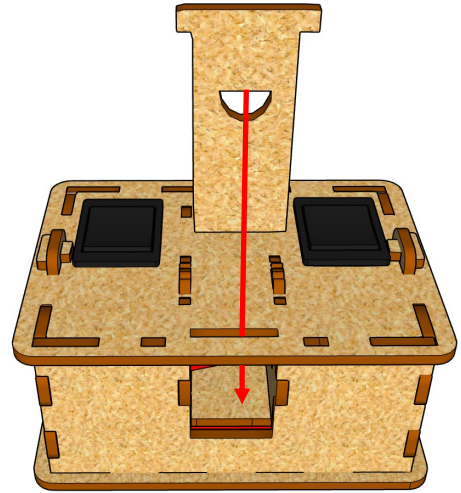
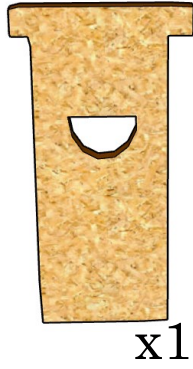

21

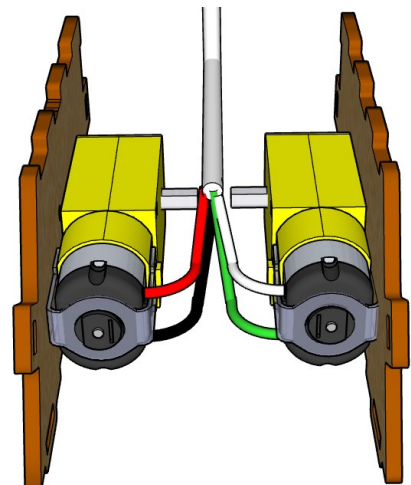
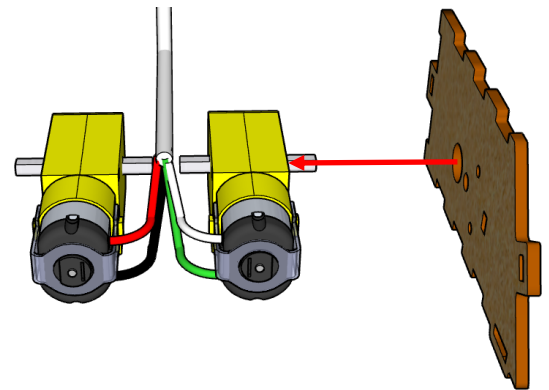
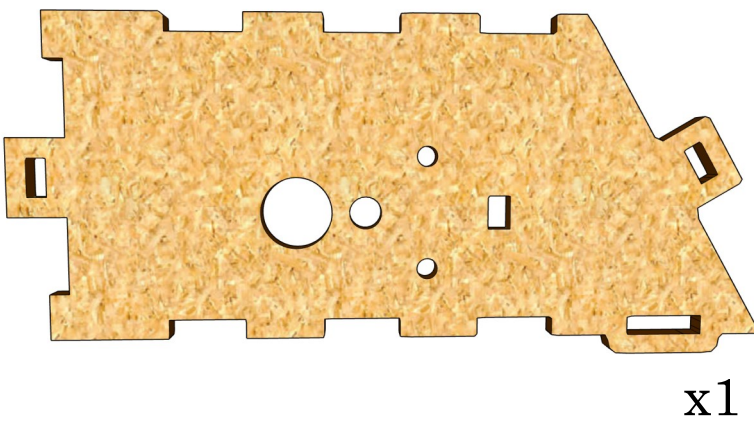

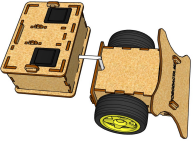

22

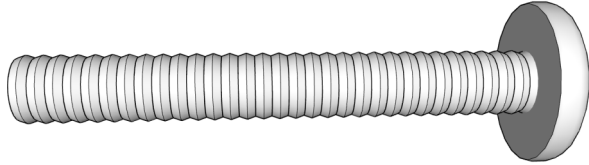
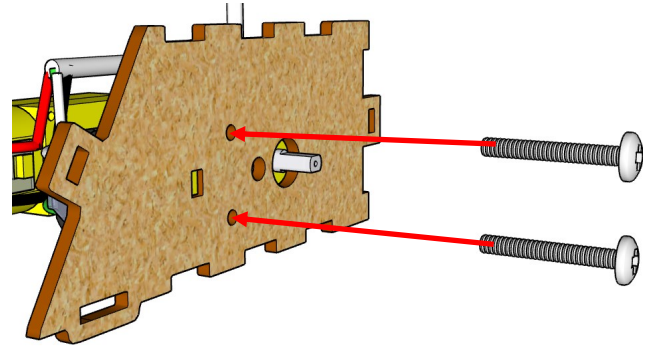

x2

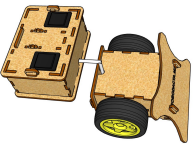
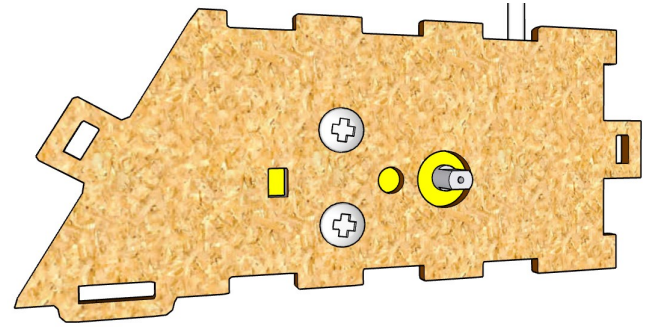

23

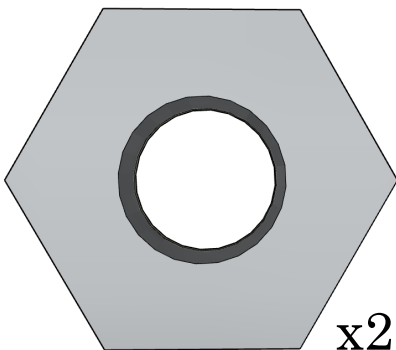
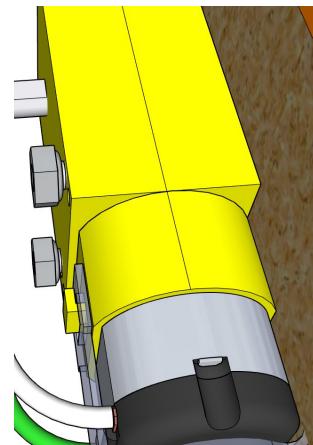
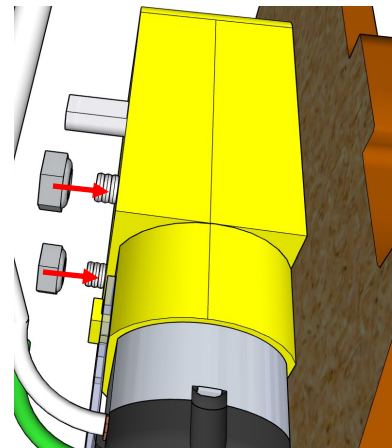

x2

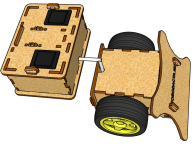

24

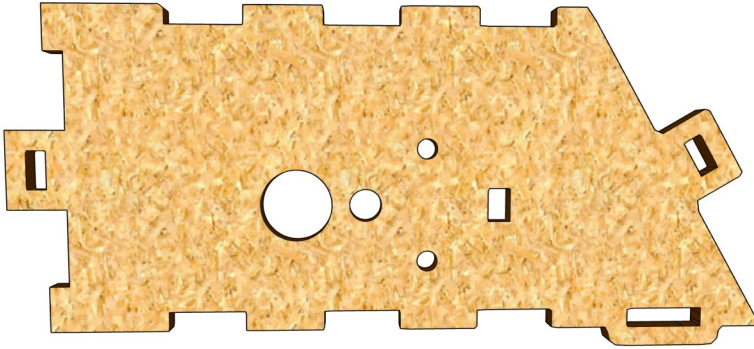

x1

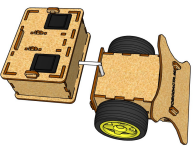
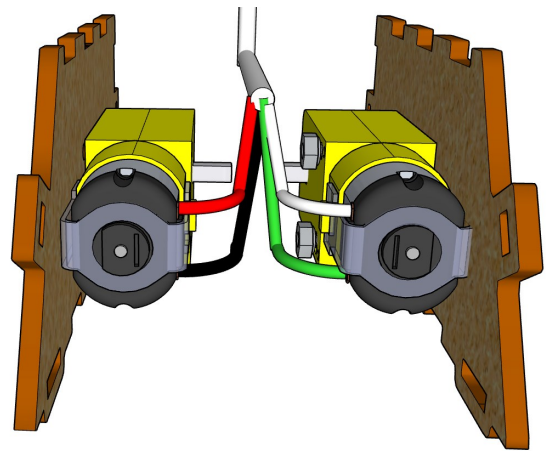
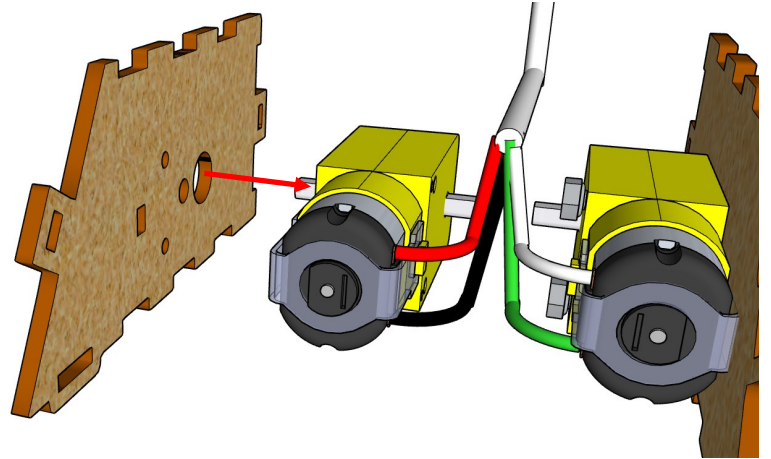

25

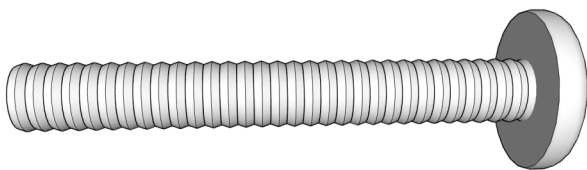

x2

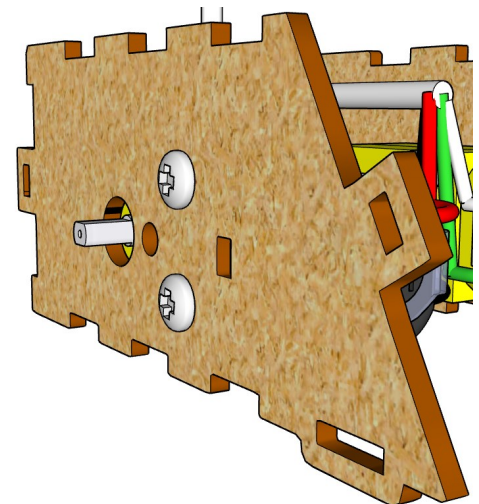
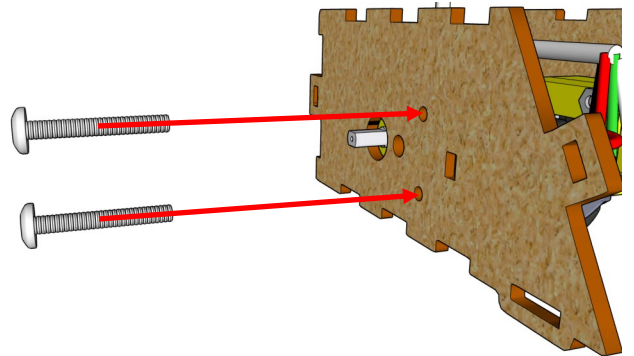

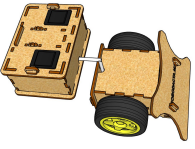

26

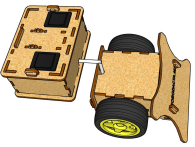
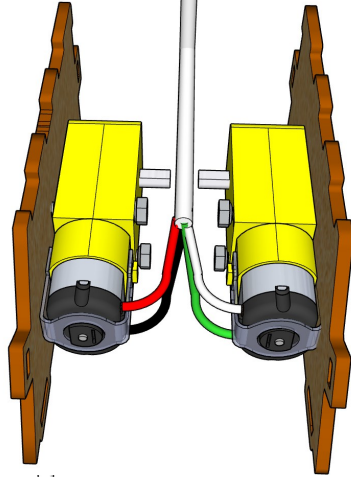
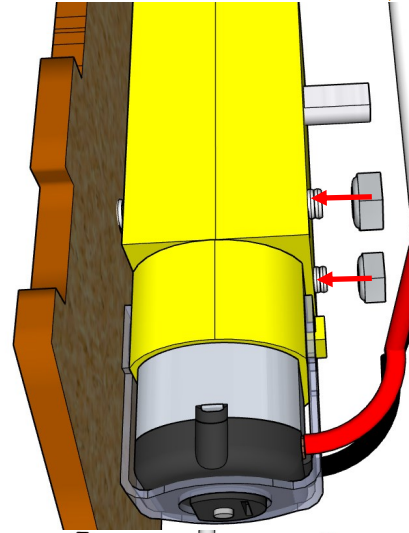
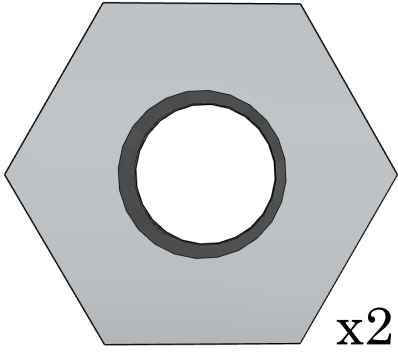

27

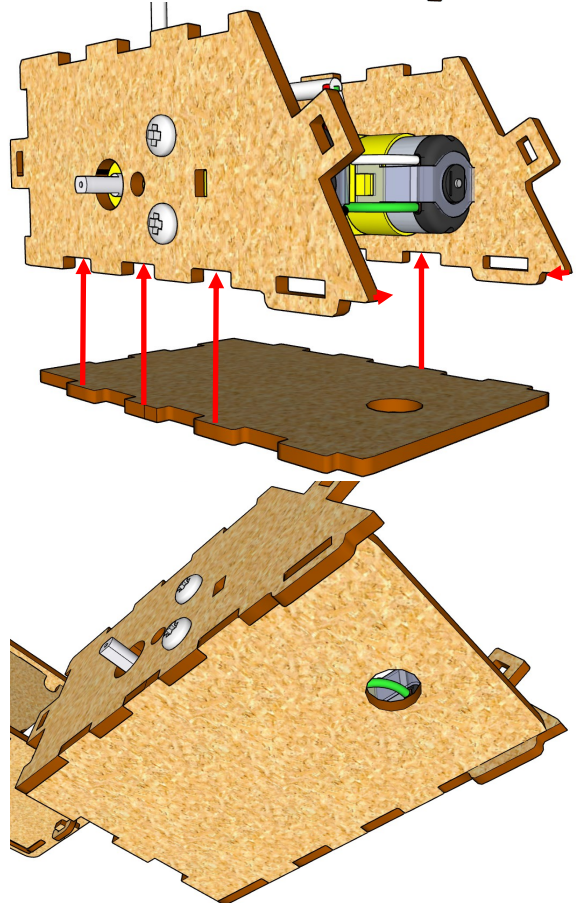
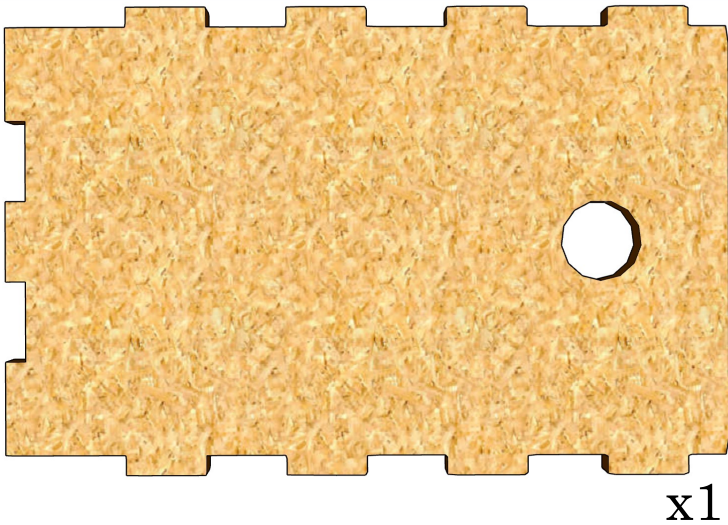

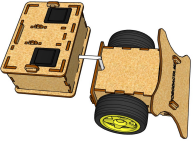

28

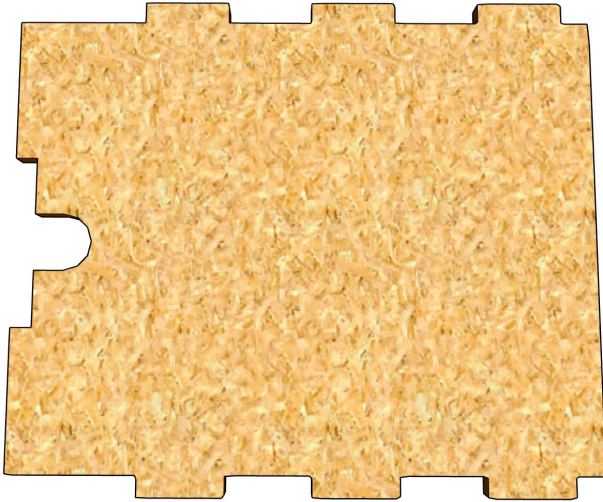

x1

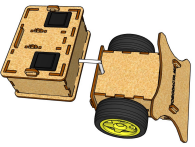
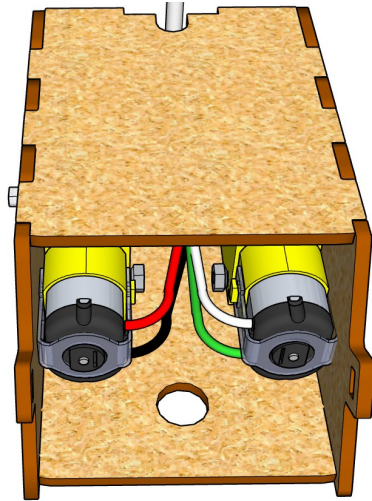
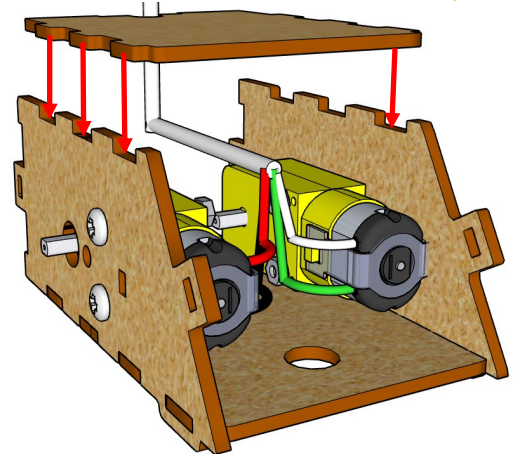

29

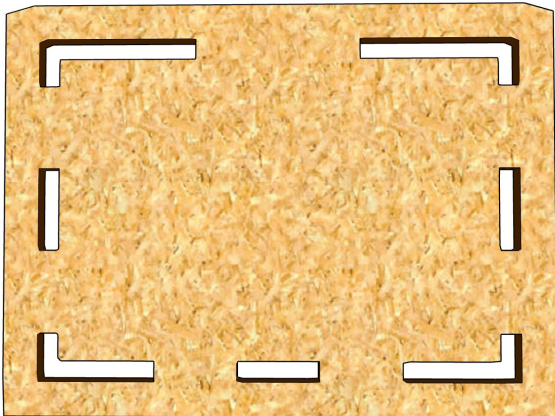

x1

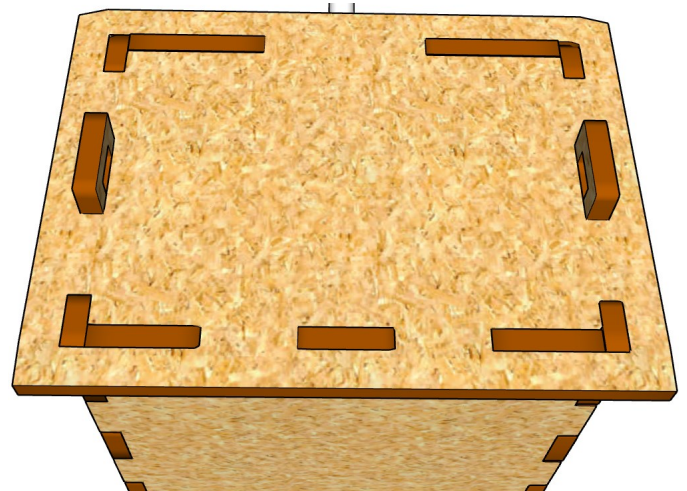
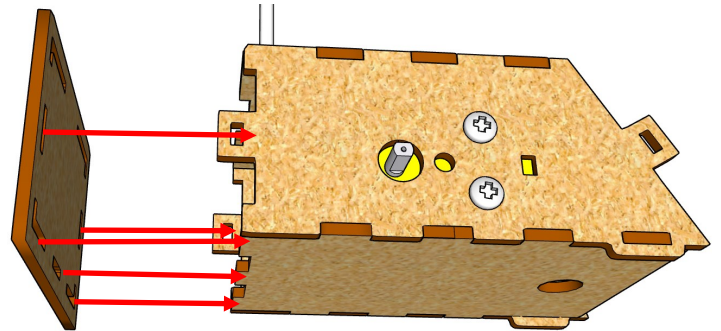

Nota: Los cinturones de seguridad deben quedar dentro del sumo.

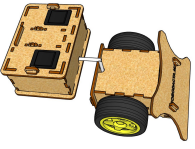

30

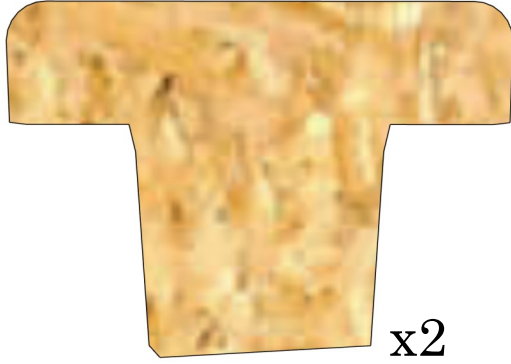

x2

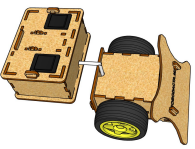
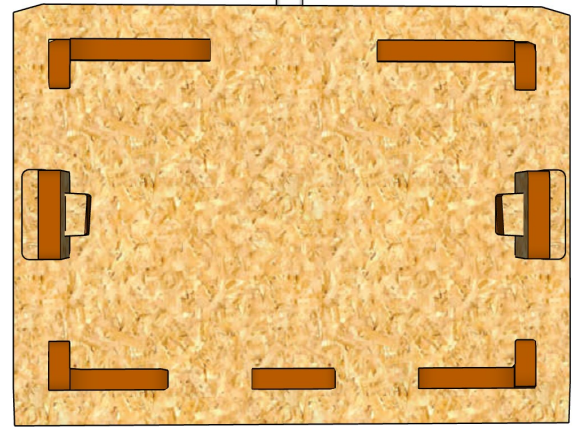
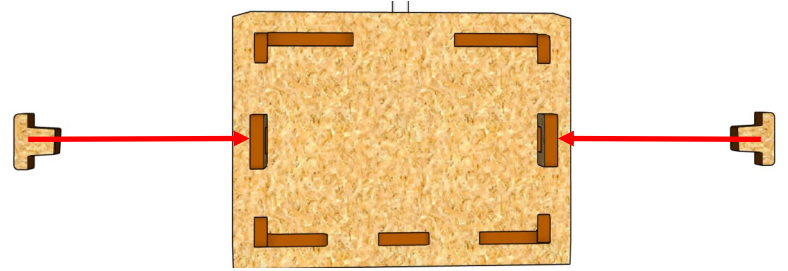

31

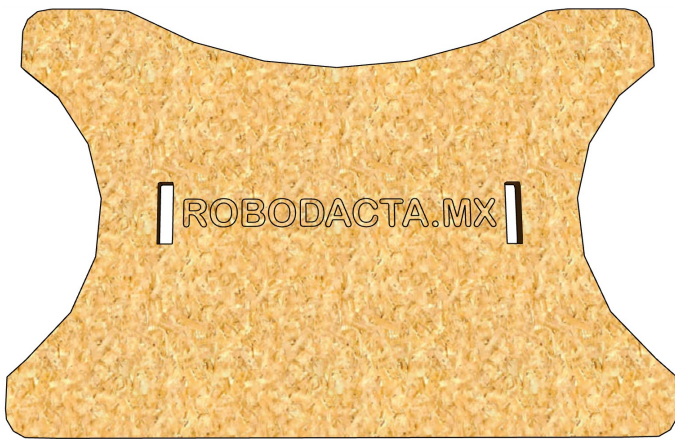

x1

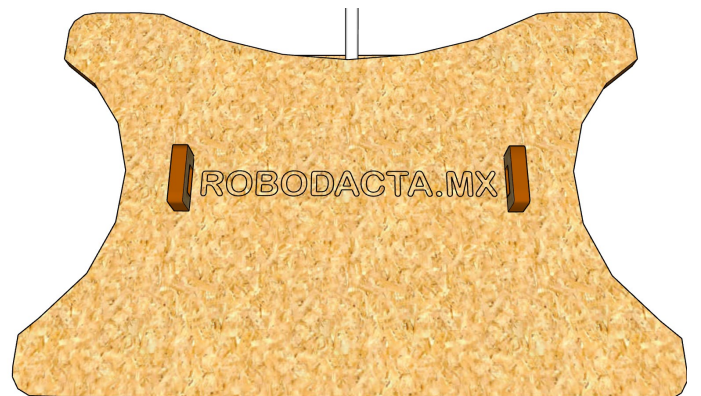
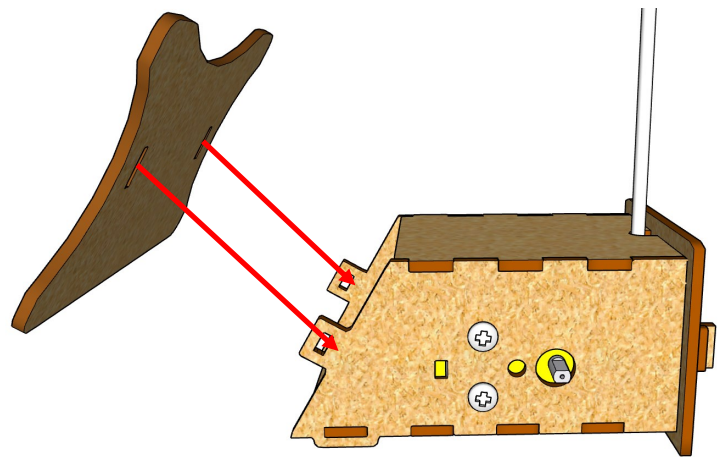

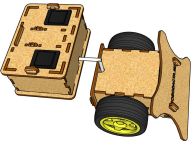

32

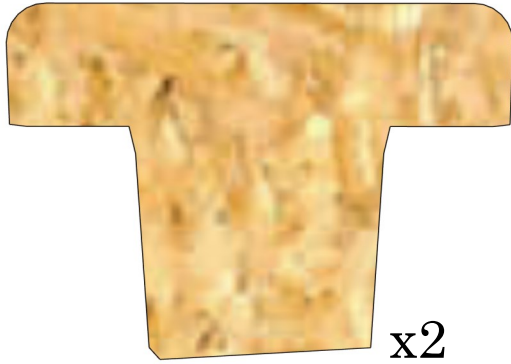

x2

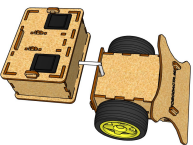
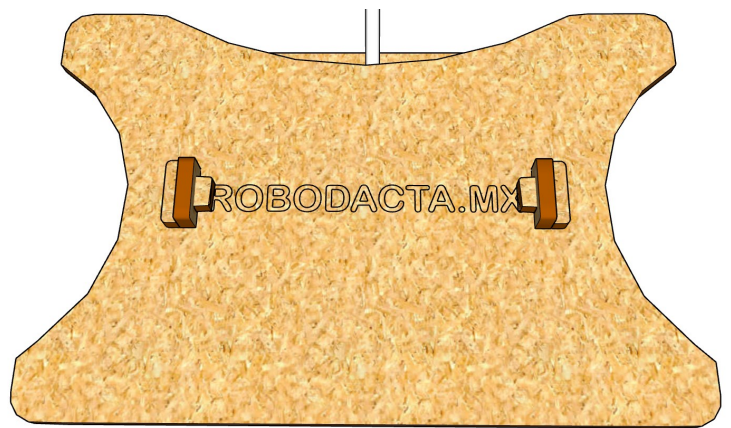
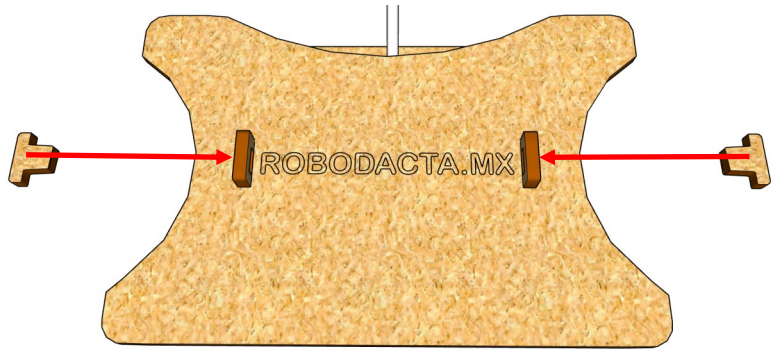

33

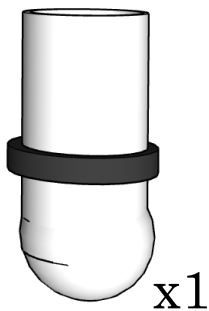

x1

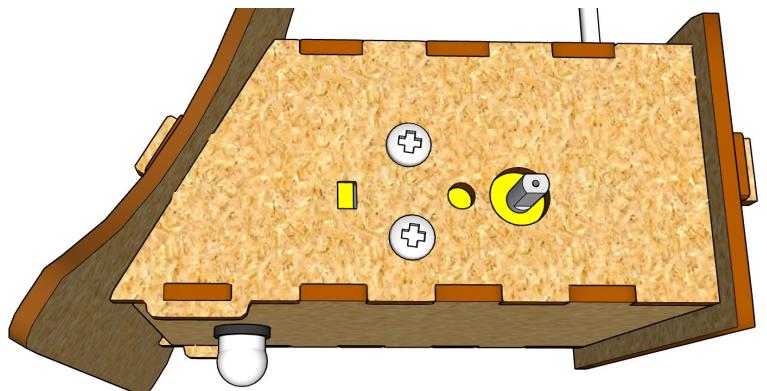
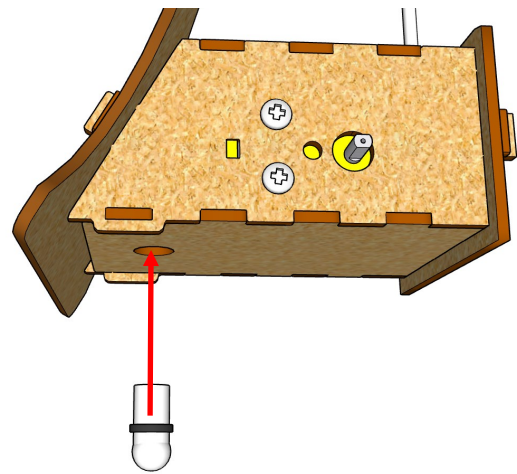

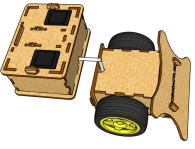

34

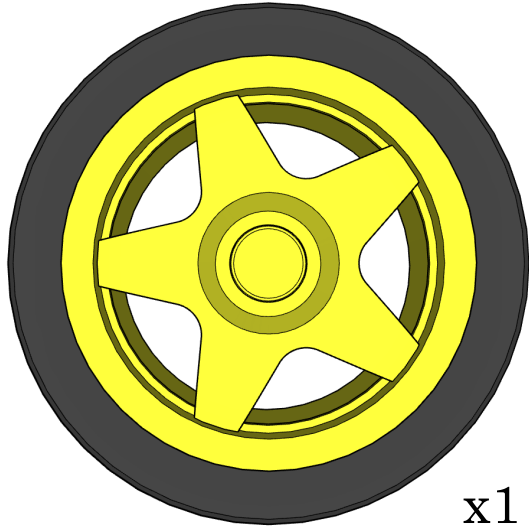

x1

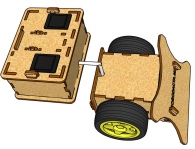
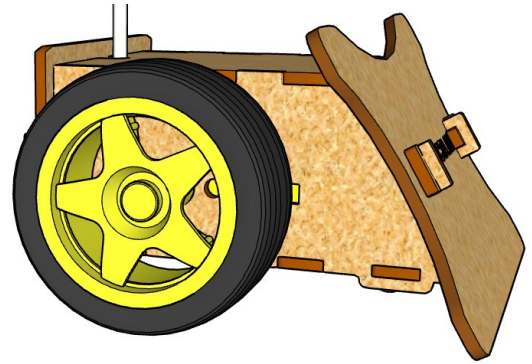
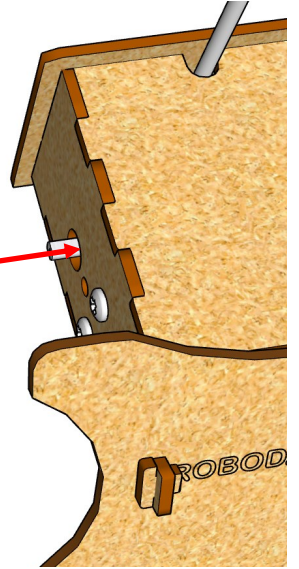
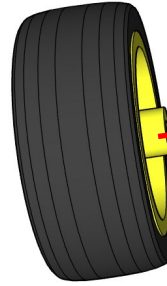

35

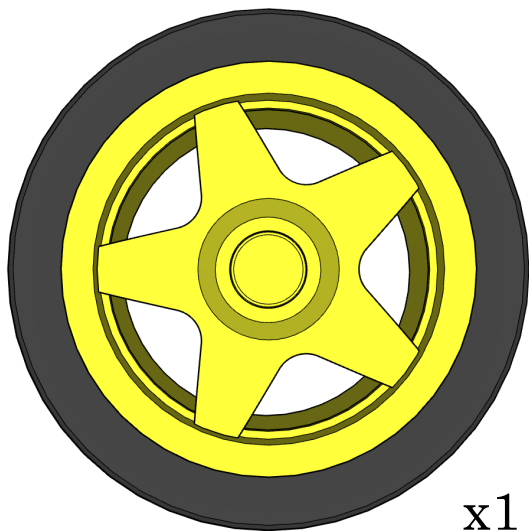

x1

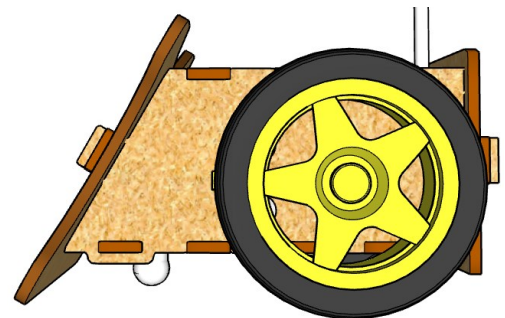
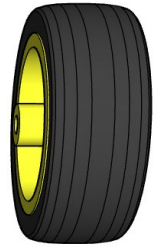
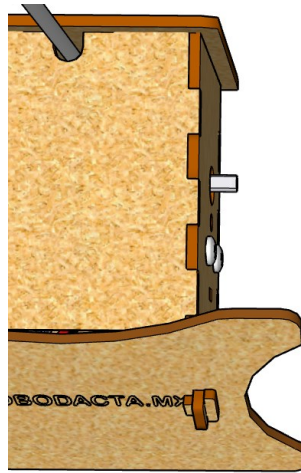

Tornillería

Utiliza el siguiente esquema para comparar y conocer las medidas de los tornillos y tuercas que necesitas durante el ensamble. Solo basta con colocar encima el tornillo o tuerca hasta que coincida con alguna de las figuras. (Para corroborar correctamente las medidas de los tornillos imprime esta hoja)

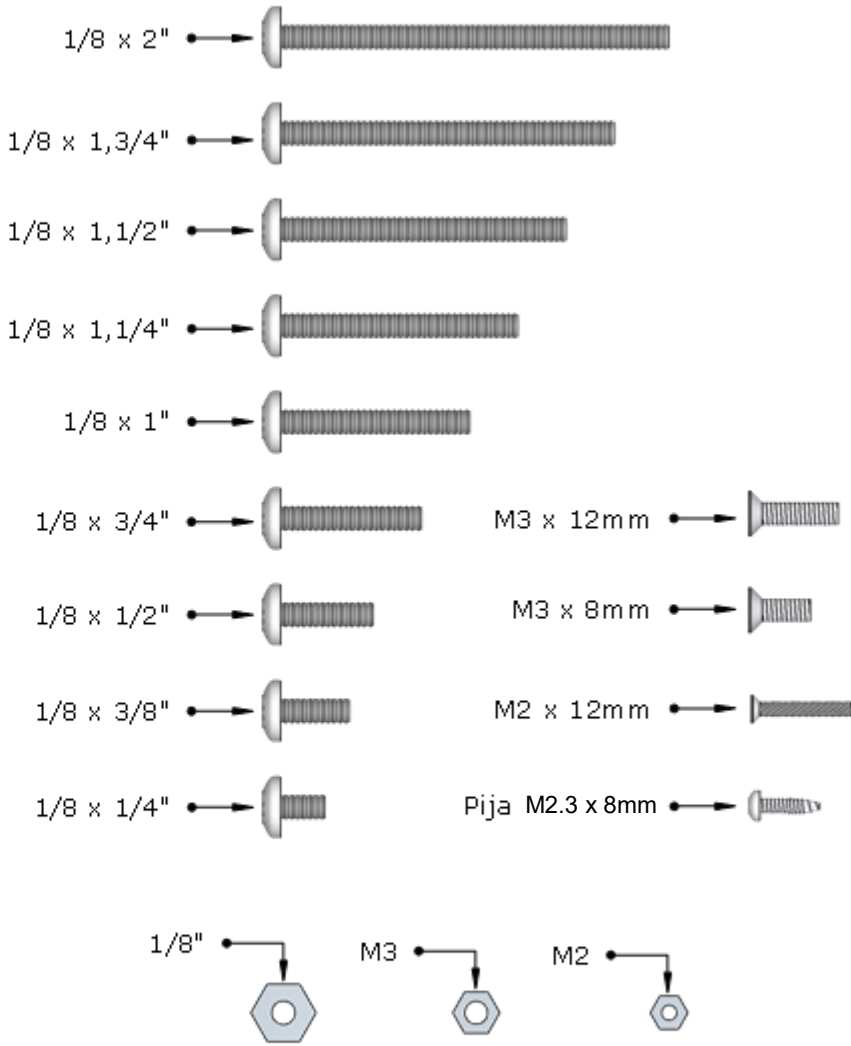

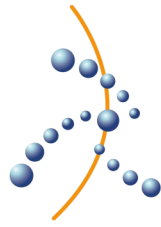

robodacta.mx
robótica didáctica

No te olvides visitar nuestro sitio web y seguirnos en nuestras redes sociales donde encontrarás más contenido.

www.robodacta.mx



@Robodacta.RD



56 28 08 95 23



@robodacta.mx



RobodactaMx