

robodacta.mx
robótica didáctica

Manual de ensamble
Kit Robot Hormiga
Código KIT1422

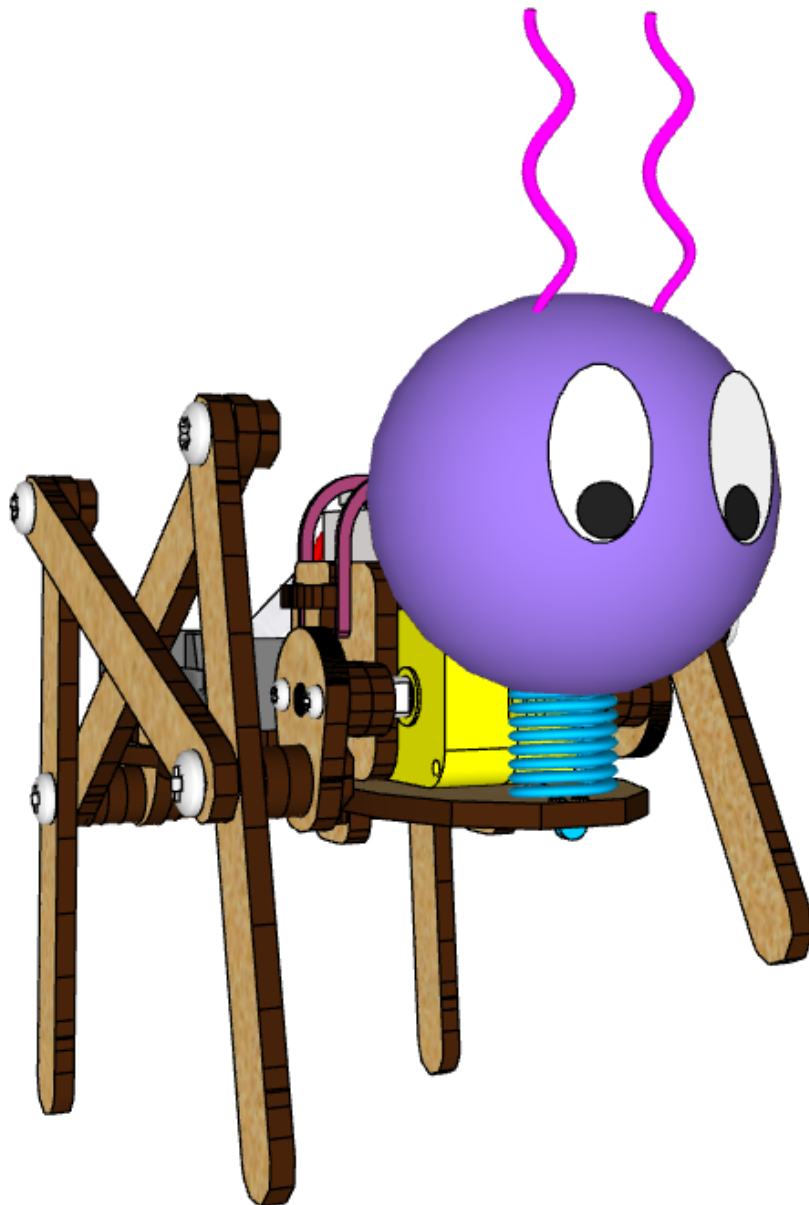

Para poder armar **la Hormiga** identifica las siguientes piezas.

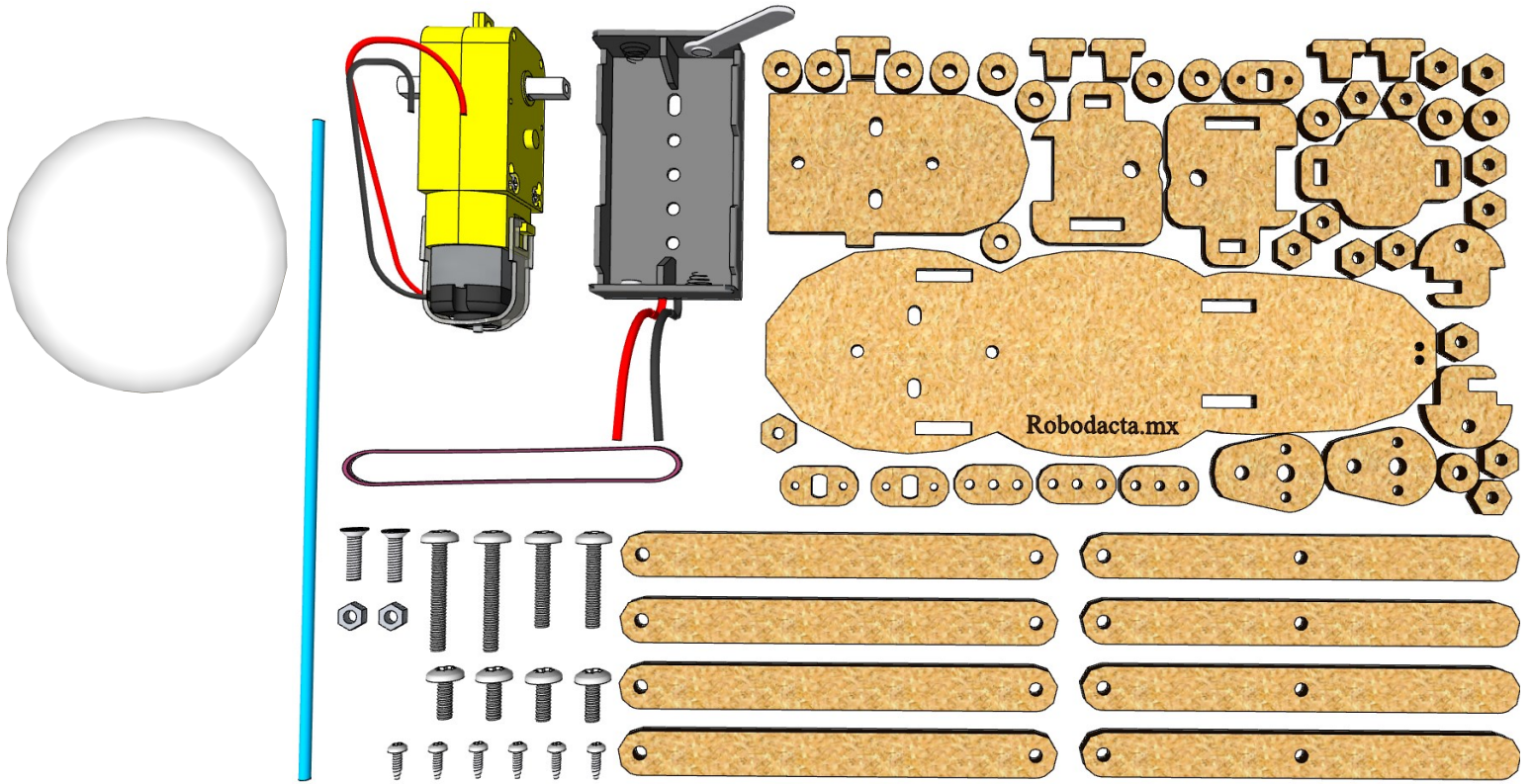

Nota: Compara tus tornillos en el apartado de la tornillería.



1

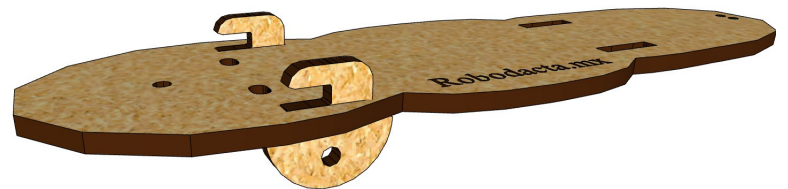
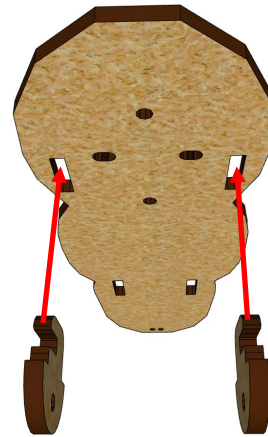
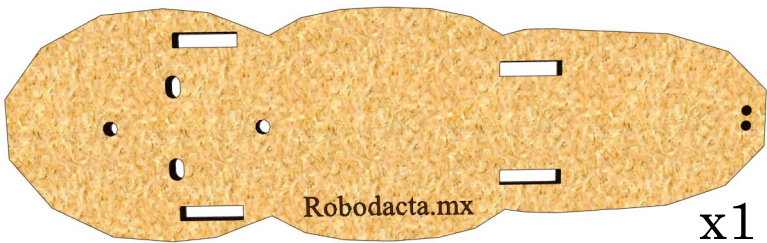



2

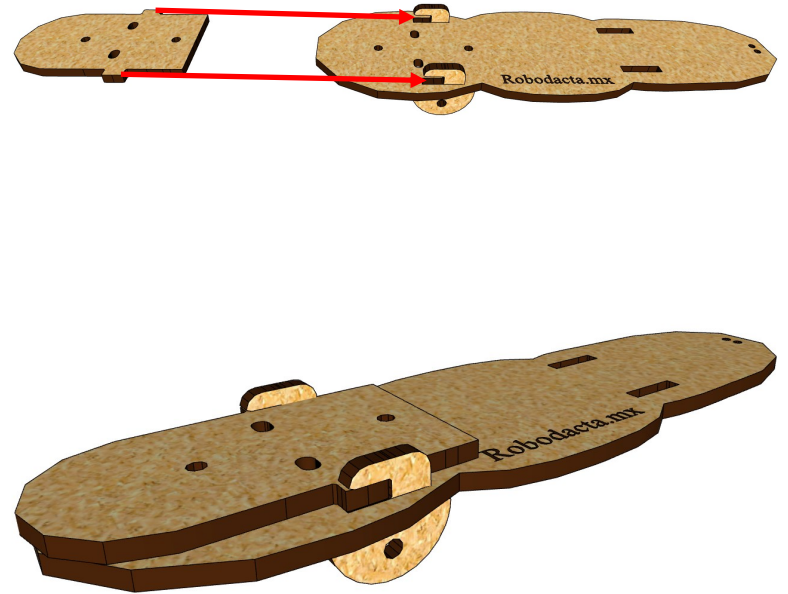
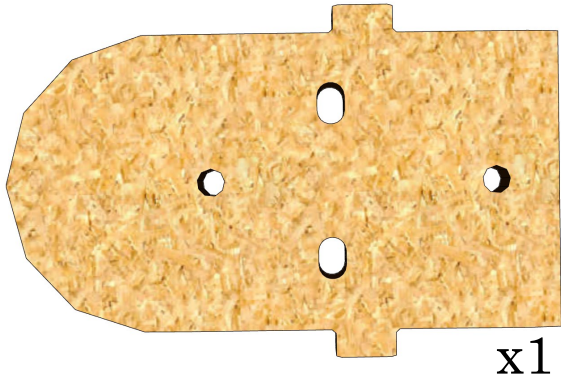

3

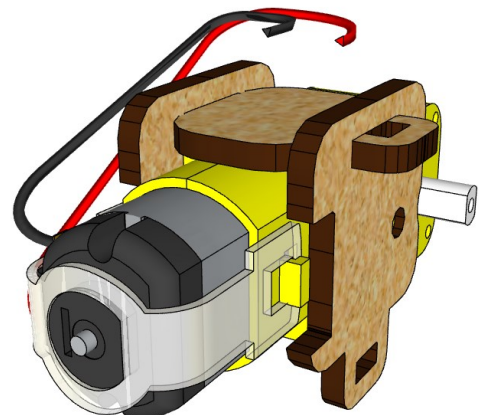
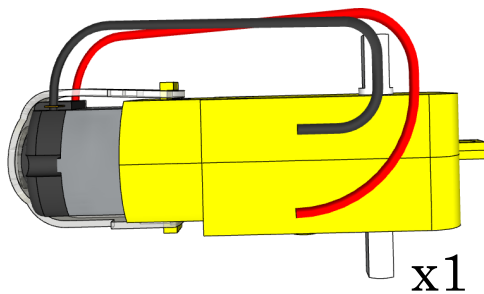
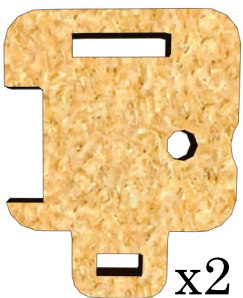
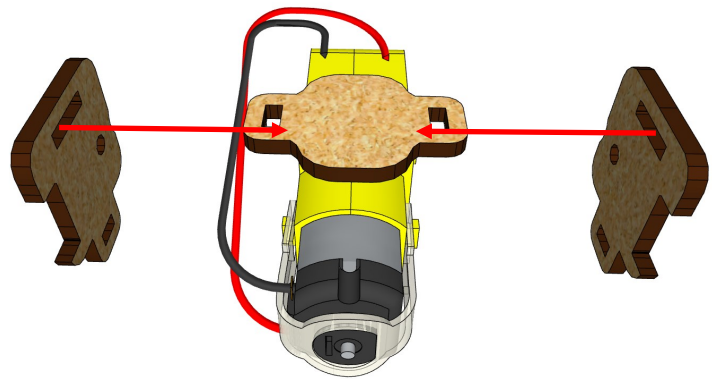
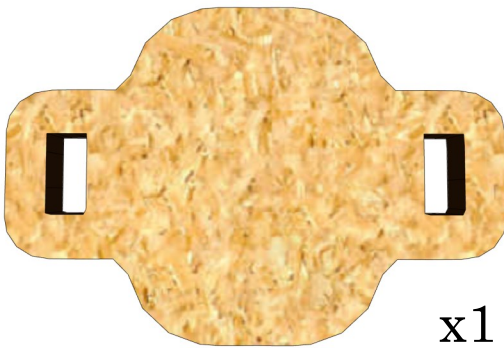



4



x2

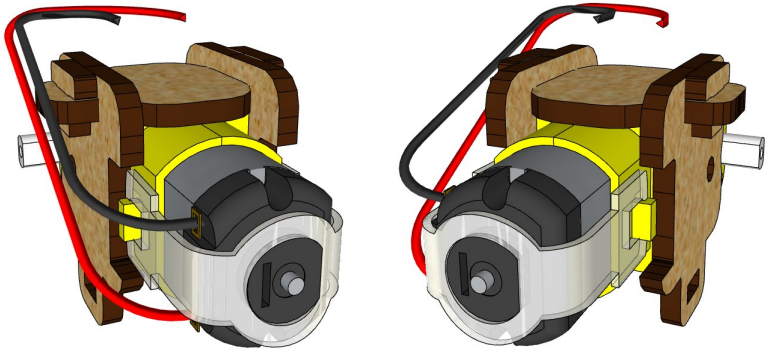
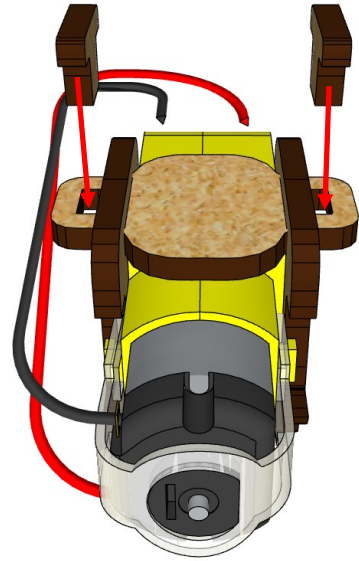

5

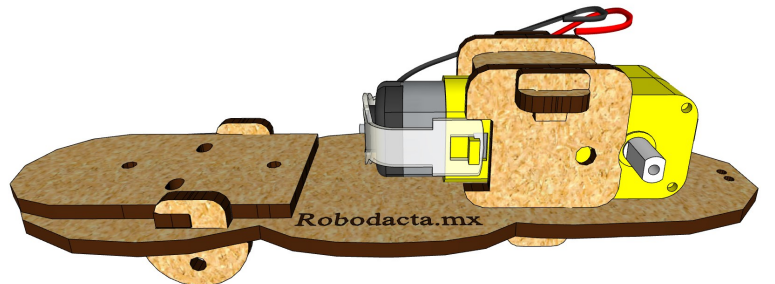
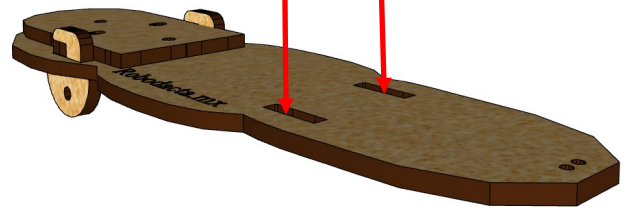
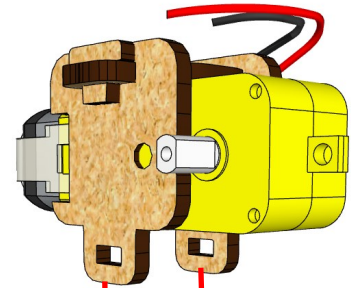



6



x2

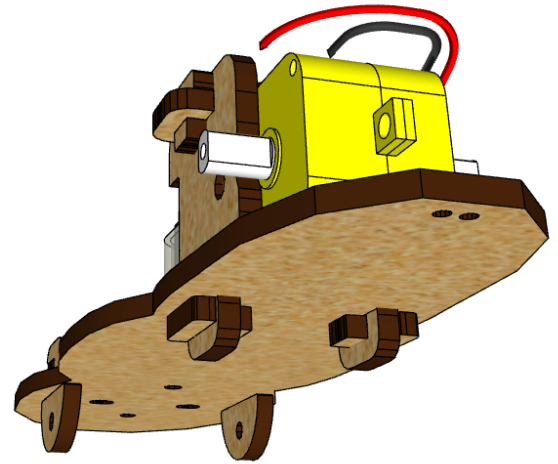
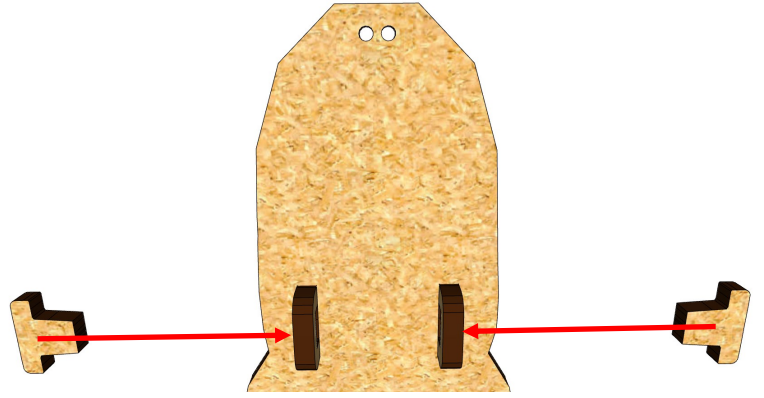

7

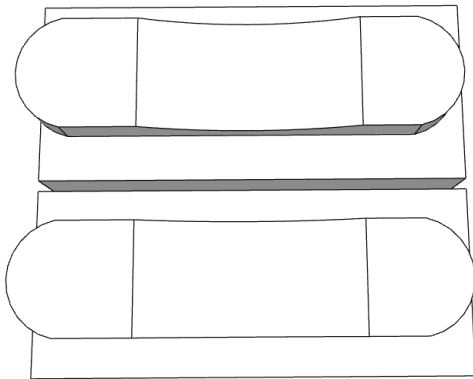

x1

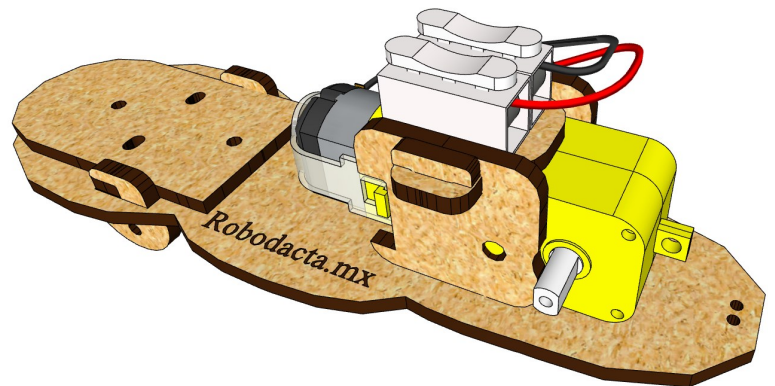
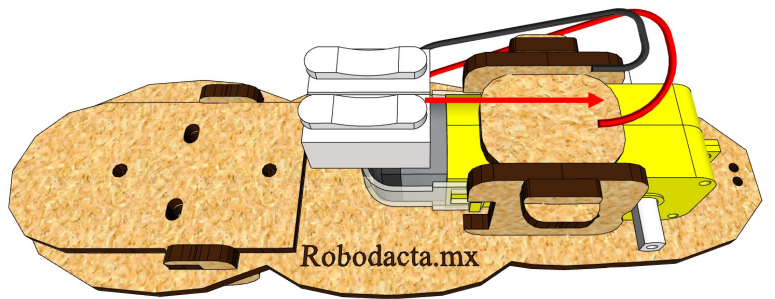



8

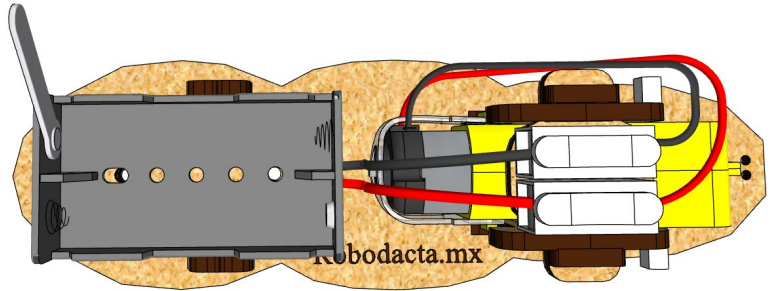
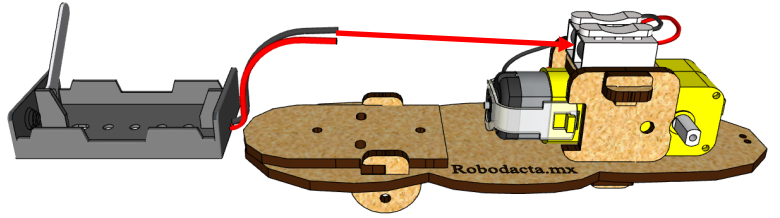
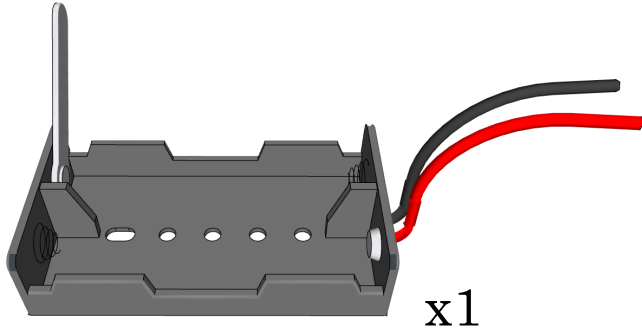

9

M3 x 12

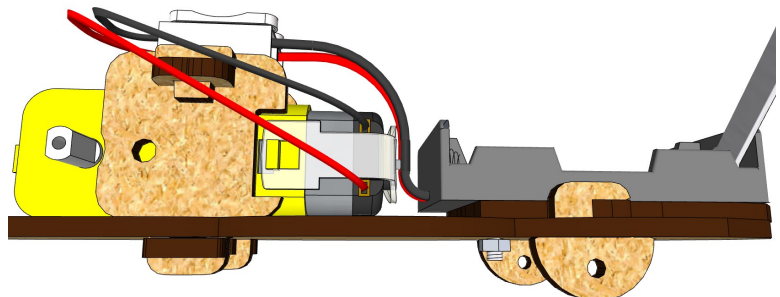
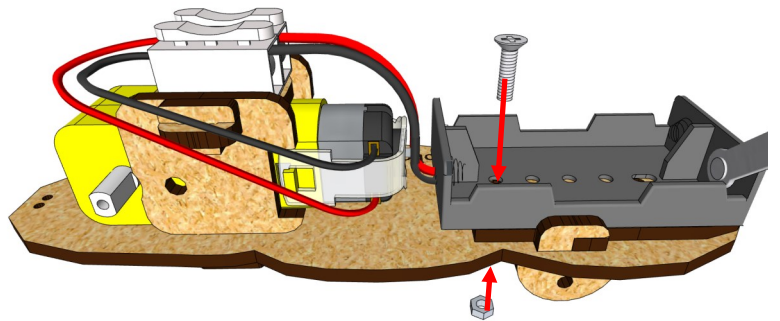
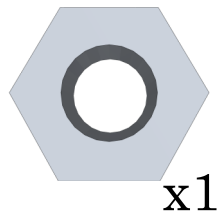



10

M3 x 12

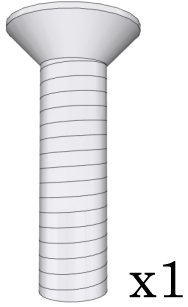

x1

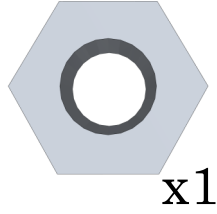

x1

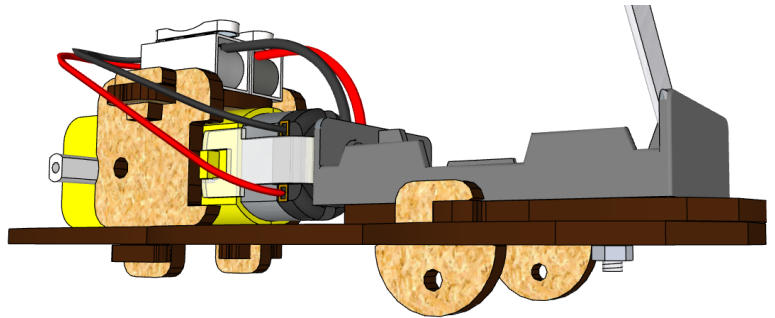
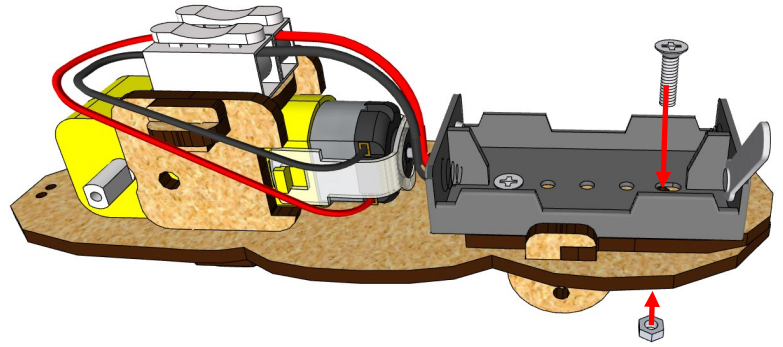

11



x1

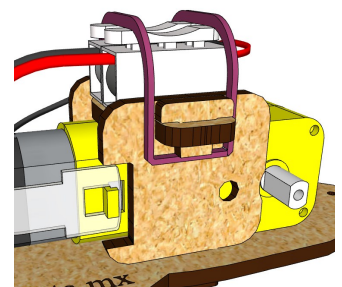
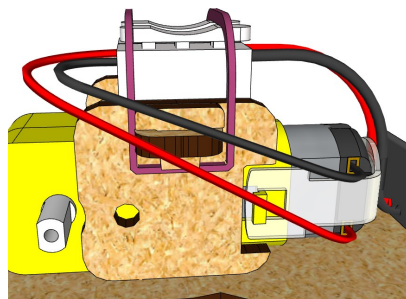
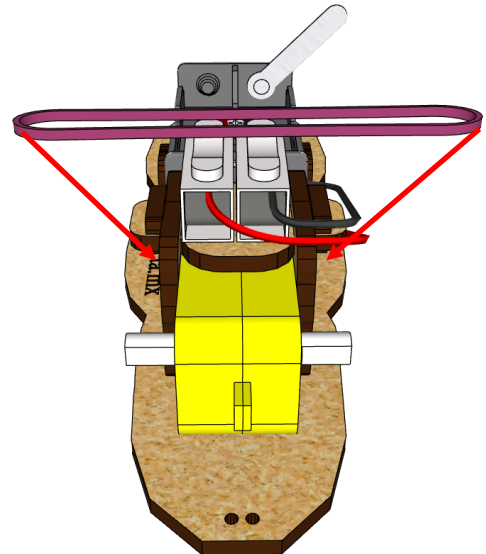



12

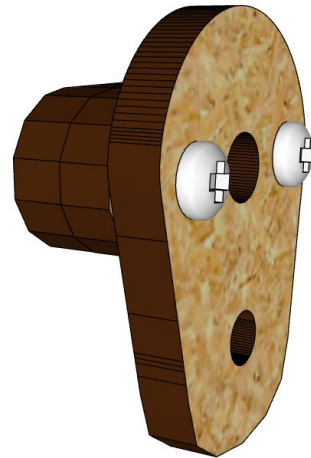
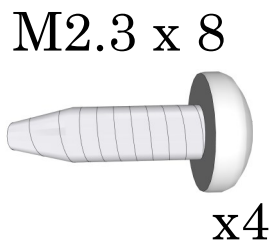
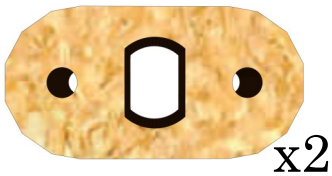
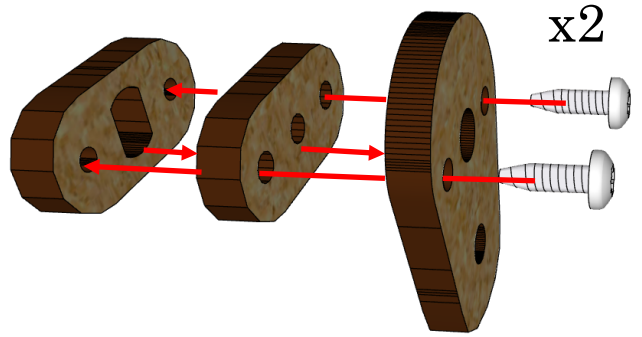
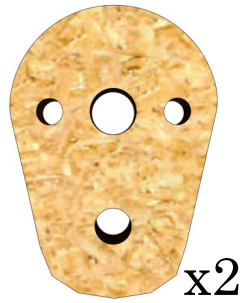
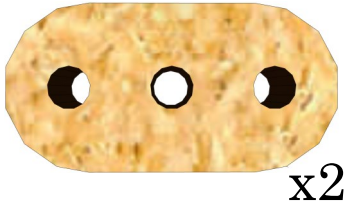

13

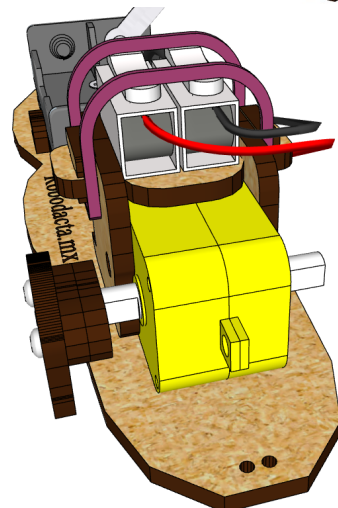
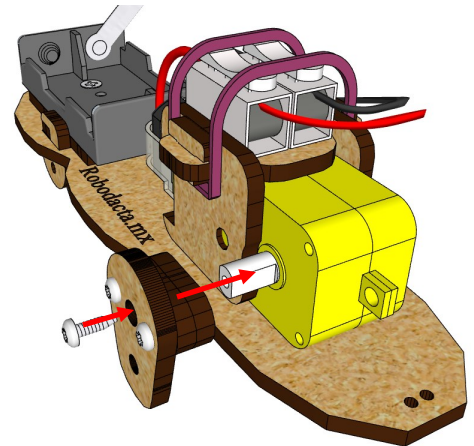
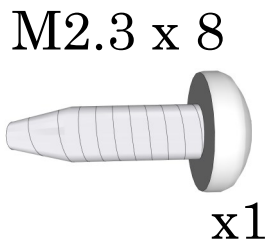
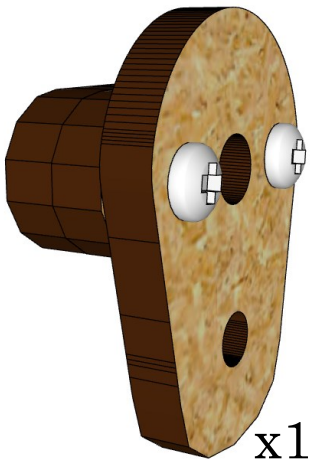

Nota: Ten en cuenta la posición de esta y la siguiente pieza, para que la hormiga funcione correctamente.



14

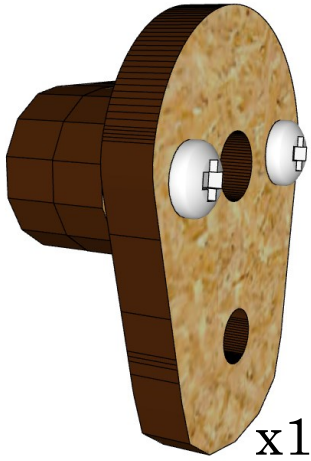

x1

M2.3 x 8

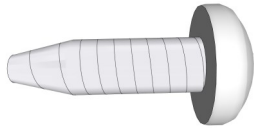

x1

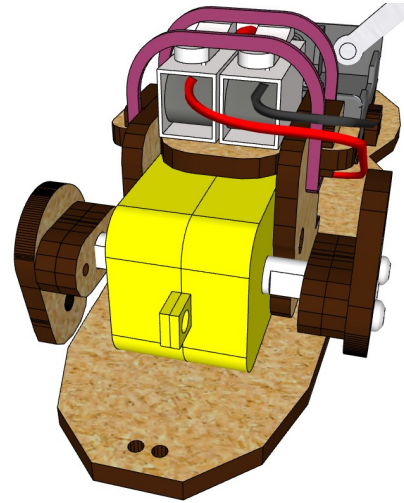
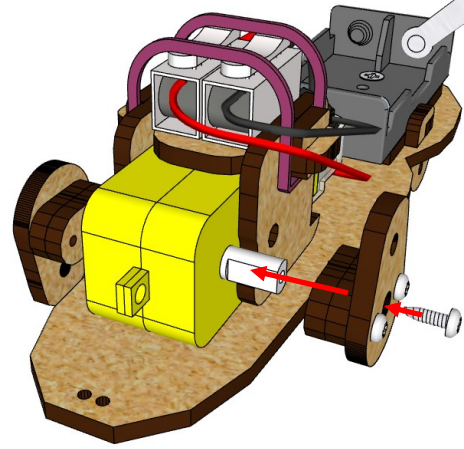

15

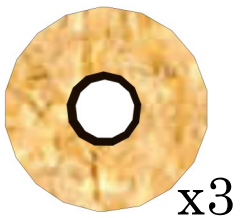

x3

1/8 x 1

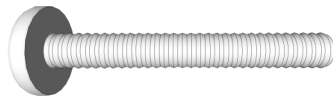

x1

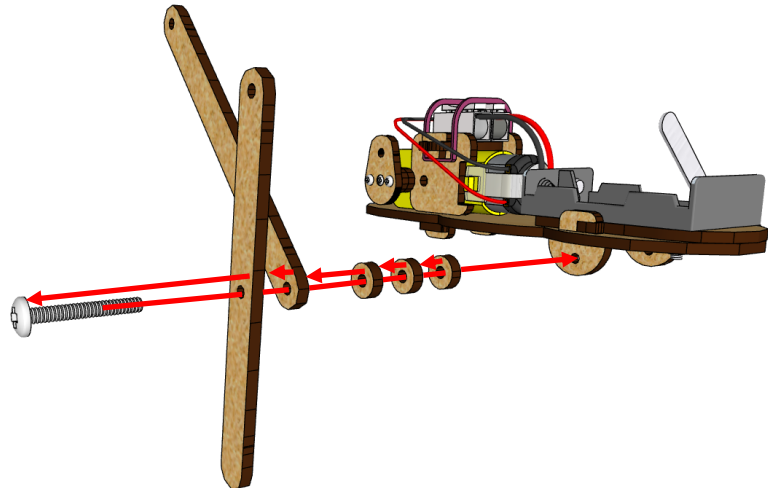

x1



x1

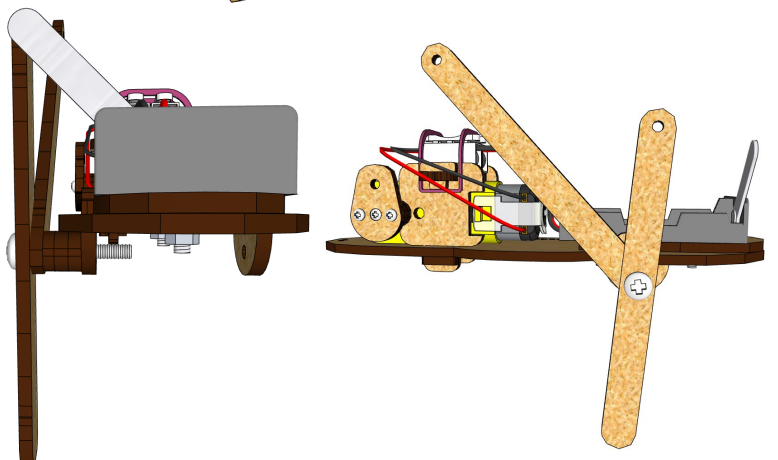



16



x1

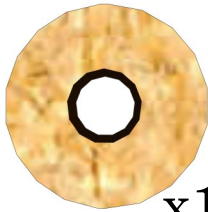

x1

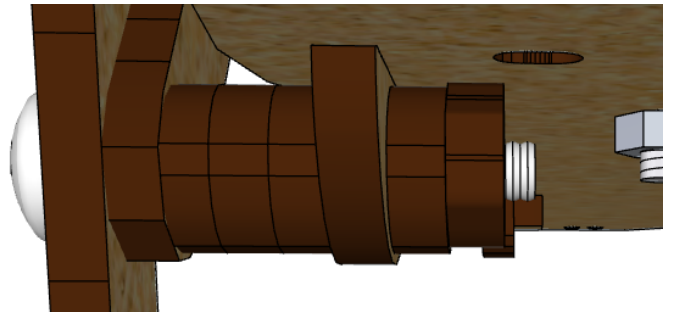
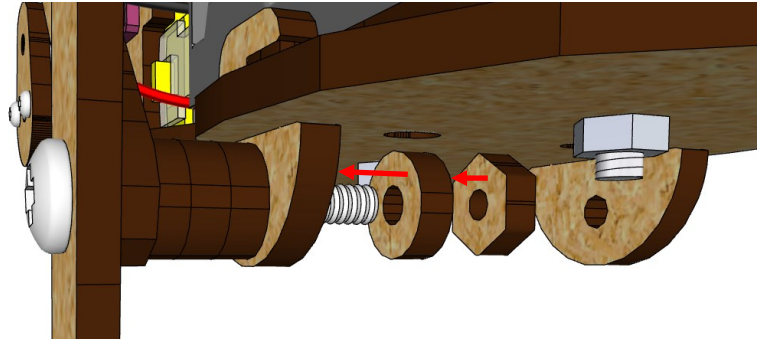
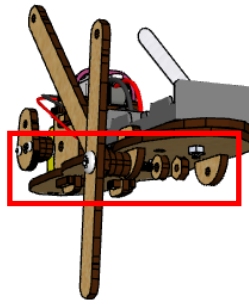

Nota: al colocar las tuercas de MDF ajusta asta el tope y regresa 1/2 de vuelta.



17

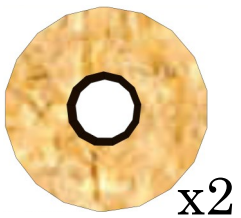

x2

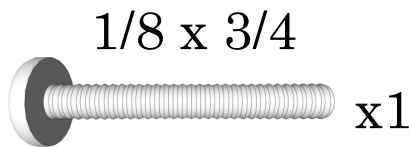

1/8 x 3/4

x1

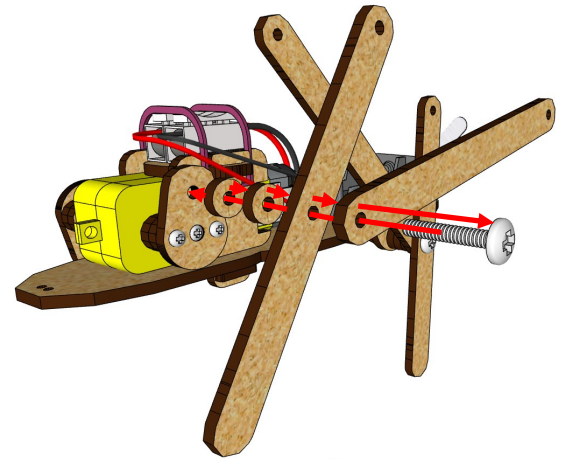

x1



x1





18

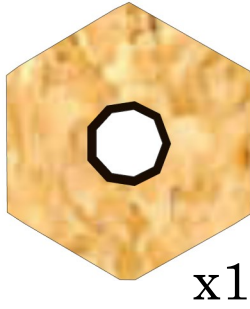

x1

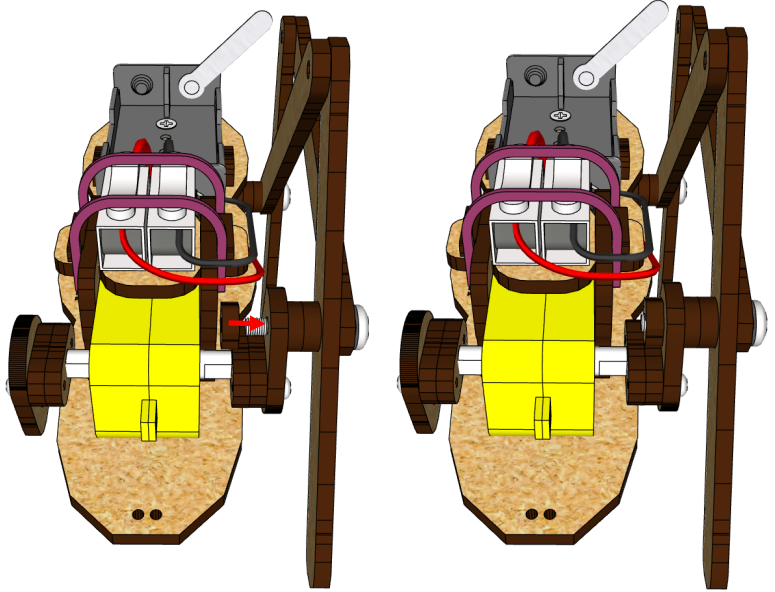

19

1/8 x 3/8

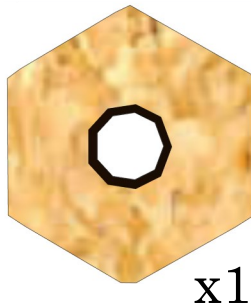
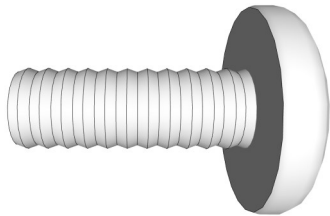

x1

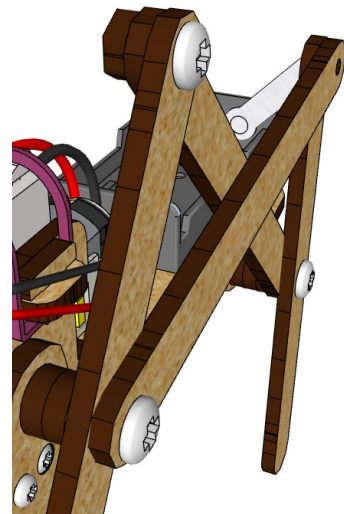



20

1/8 x 3/8

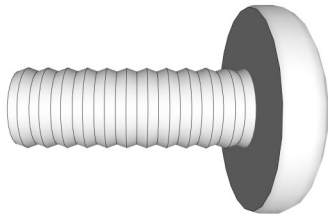

x1

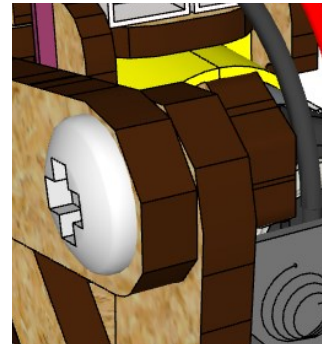
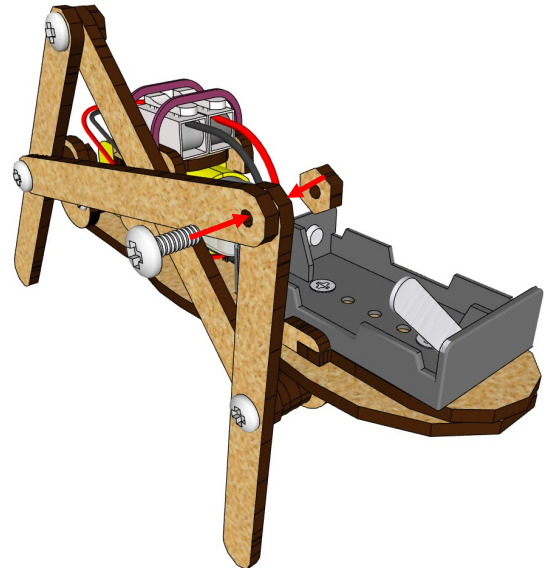

21

1/8 x 1

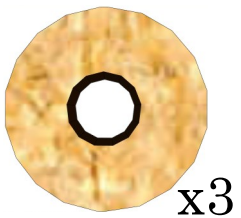

x3

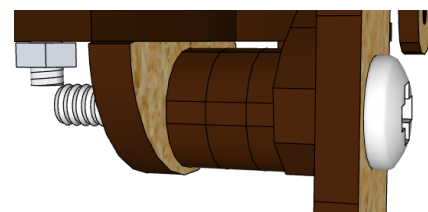
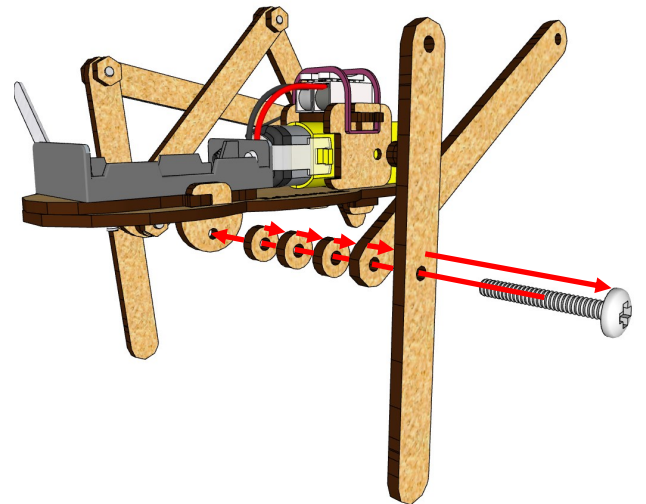
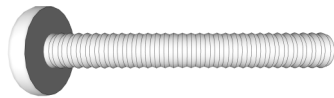



22



x1

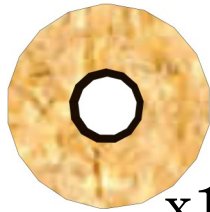

x1

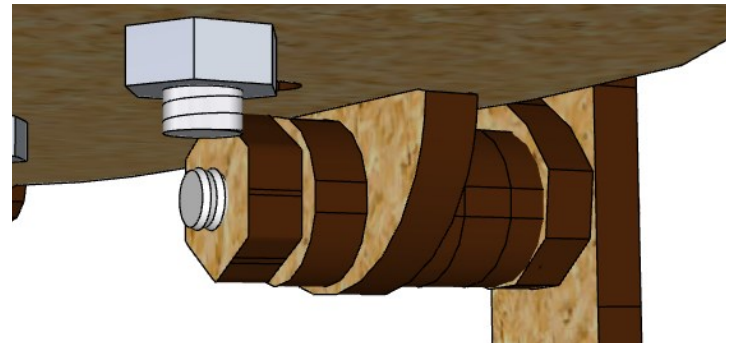
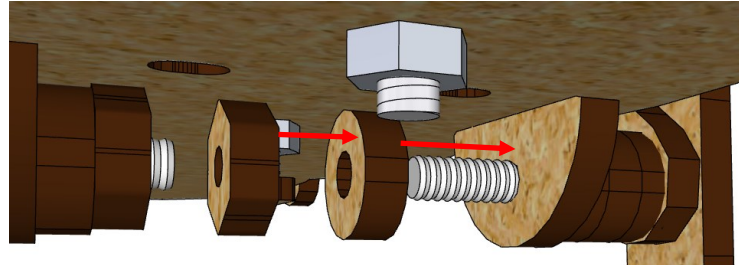
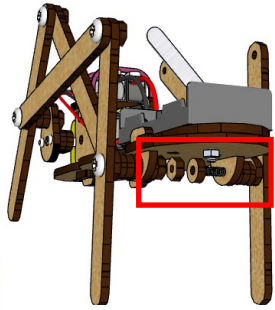

23

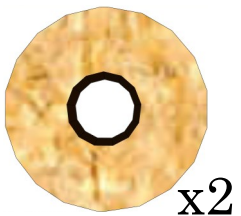

x2

1/8 x 3/4

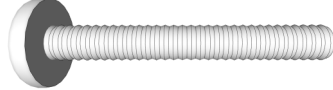

x1

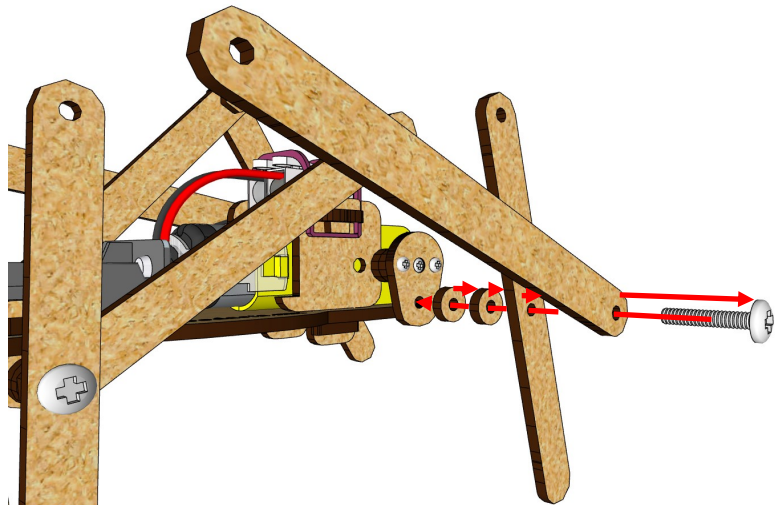

x1



x1

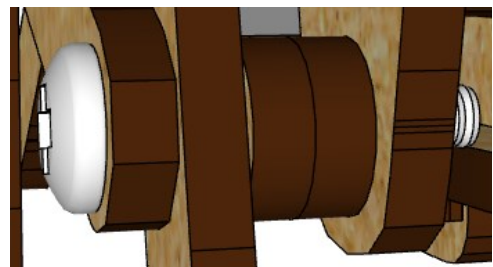



24

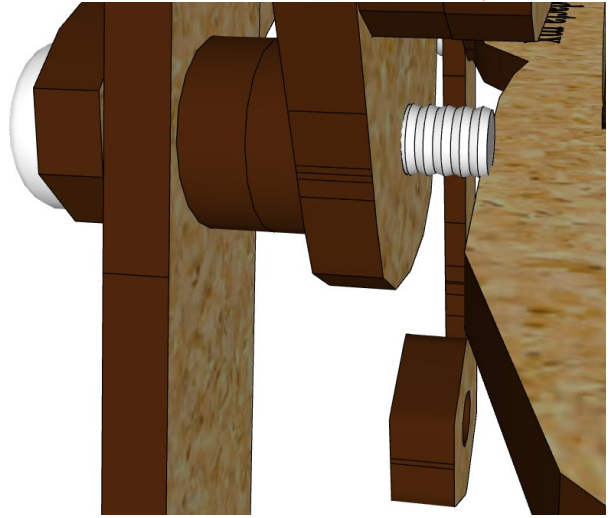
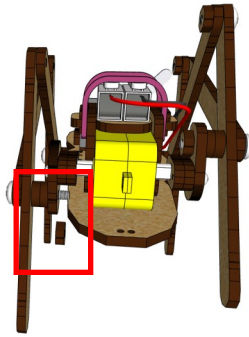

x1

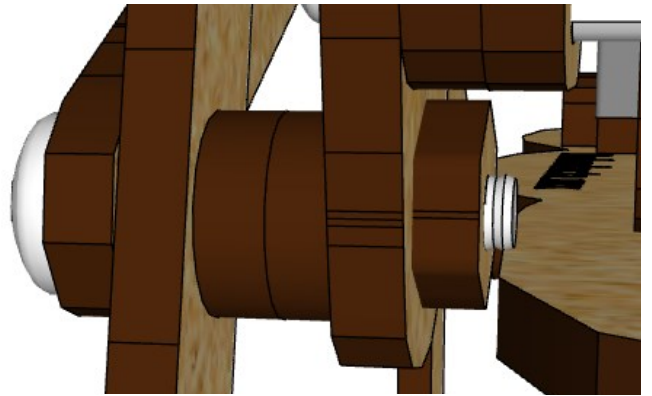

25

1/8 x 3/8

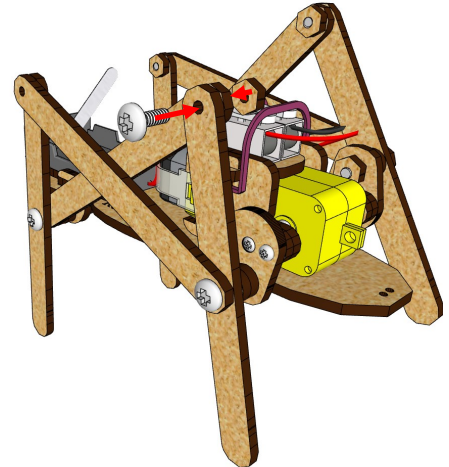
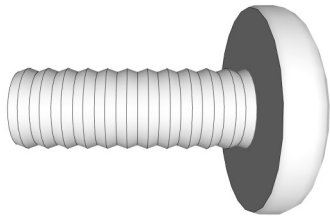

x1

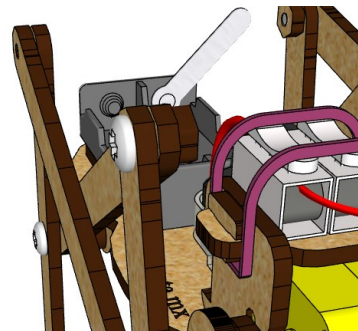



26

1/8 x 3/8

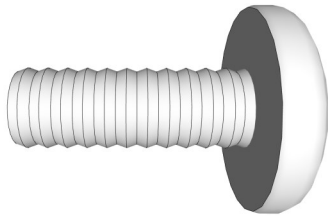

x1

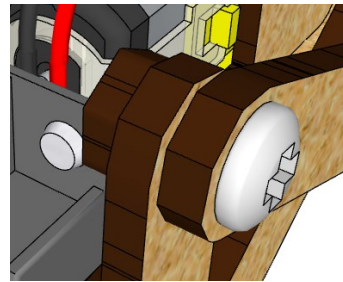
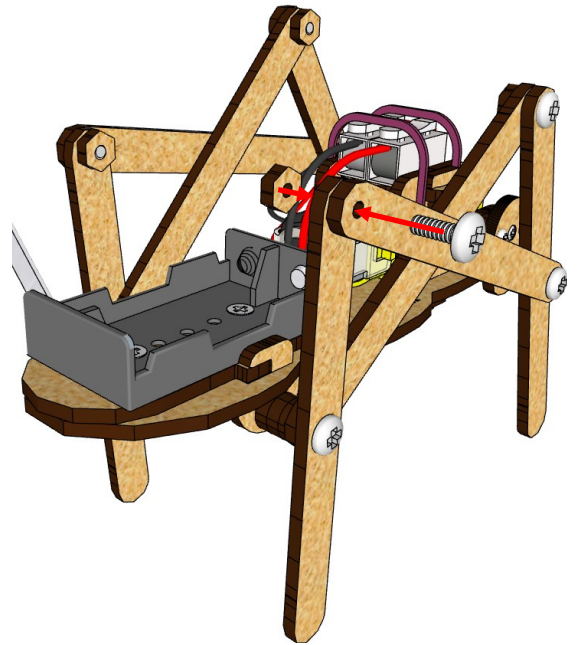

27



x1

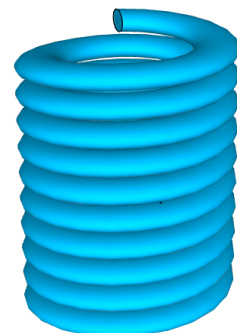



28

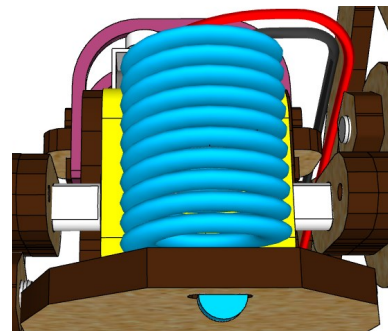
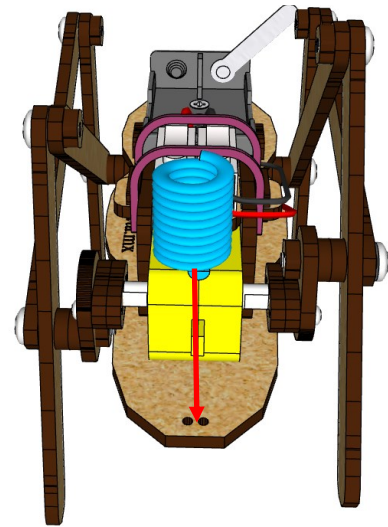
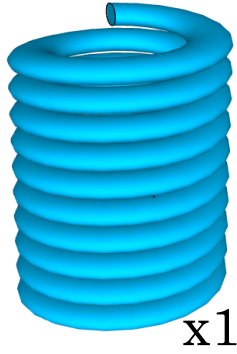

29

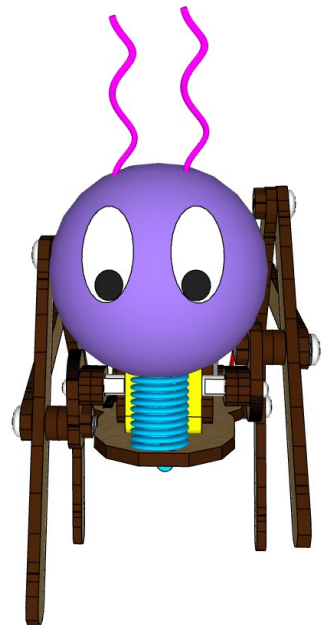
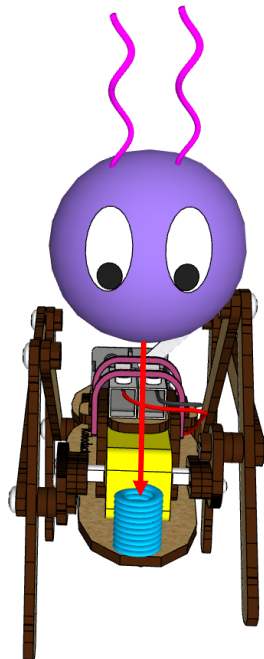
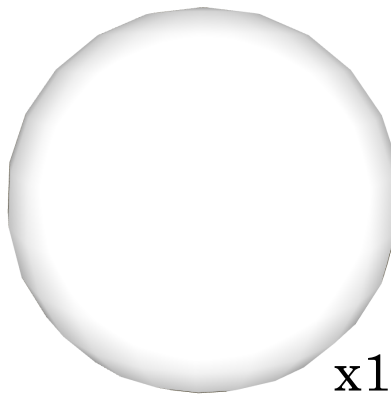

Nota: personaliza la cabeza de tu hormiga

Tornillería

Utiliza el siguiente esquema para comparar y conocer las medidas de los tornillos y tuercas que necesitas durante el ensamble. Solo basta con colocar encima el tornillo o tuerca hasta que coincida con alguna de las figuras. (Para corroborar correctamente las medidas de los tornillos imprime esta hoja)

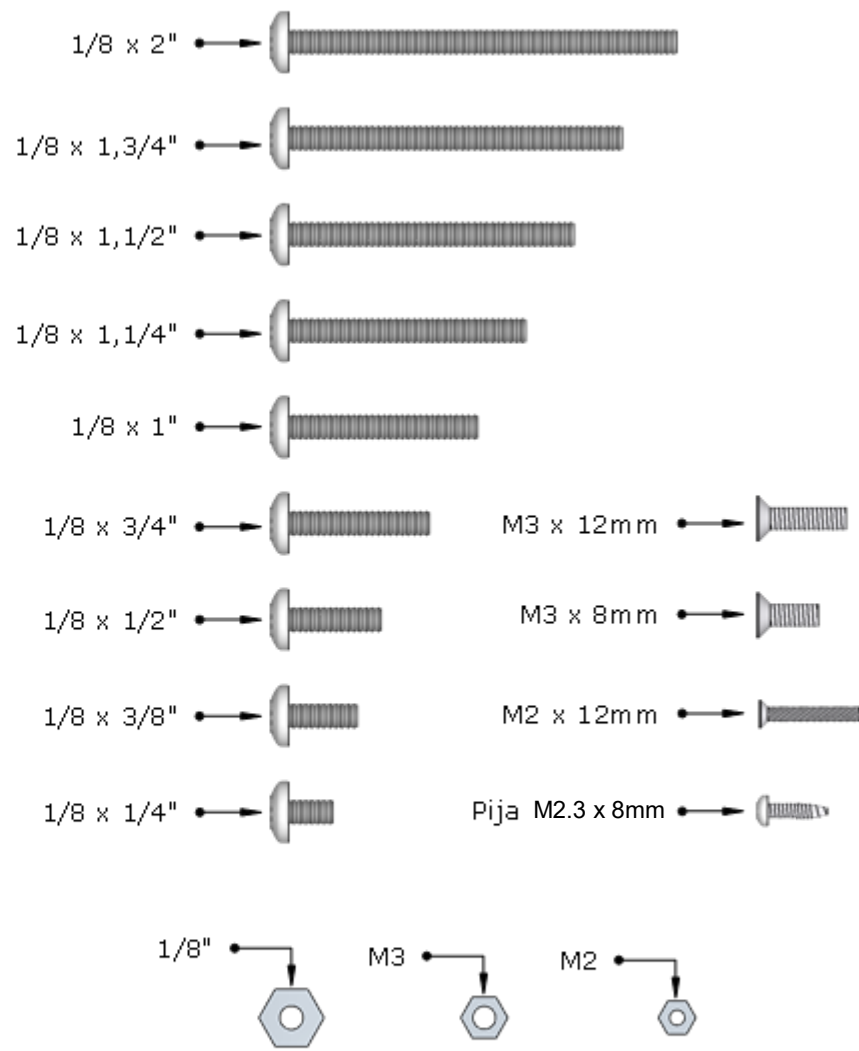

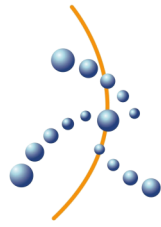

robodacta.mx
robótica didáctica

No te olvides visitar nuestro sitio web y seguirnos en nuestras redes sociales donde encontrarás más contenido.

www.robodacta.mx



@Robodacta.RD



56 28 08 95 23



@robodacta.mx



RobodactaMx