

**robodacta**.mx  
robótica didáctica

Manual de ensamble  
**Kit Carro Direccional**

Código KIT1199

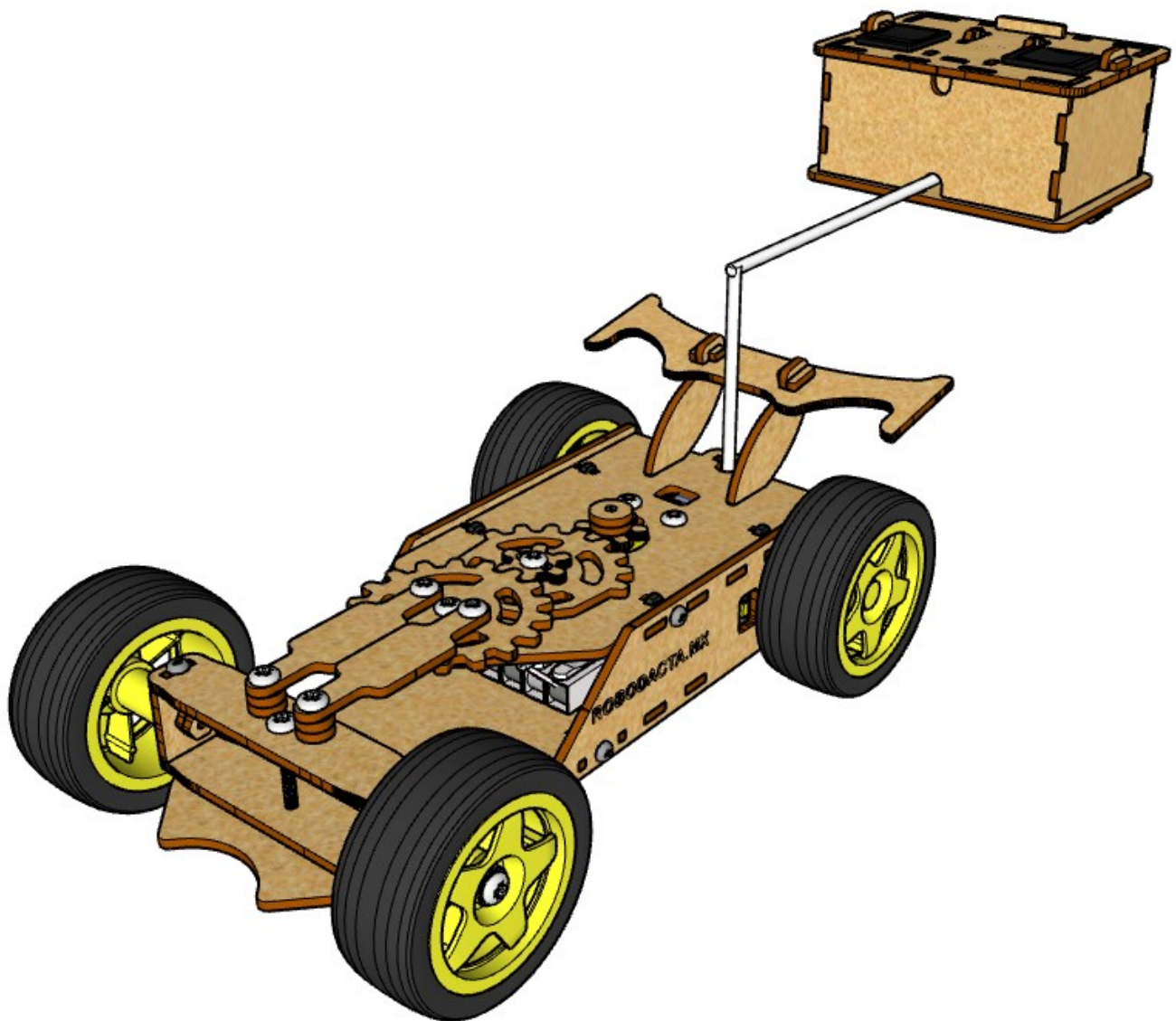

*Para poder armar el **Carro Direccional** identifica las siguientes piezas.*

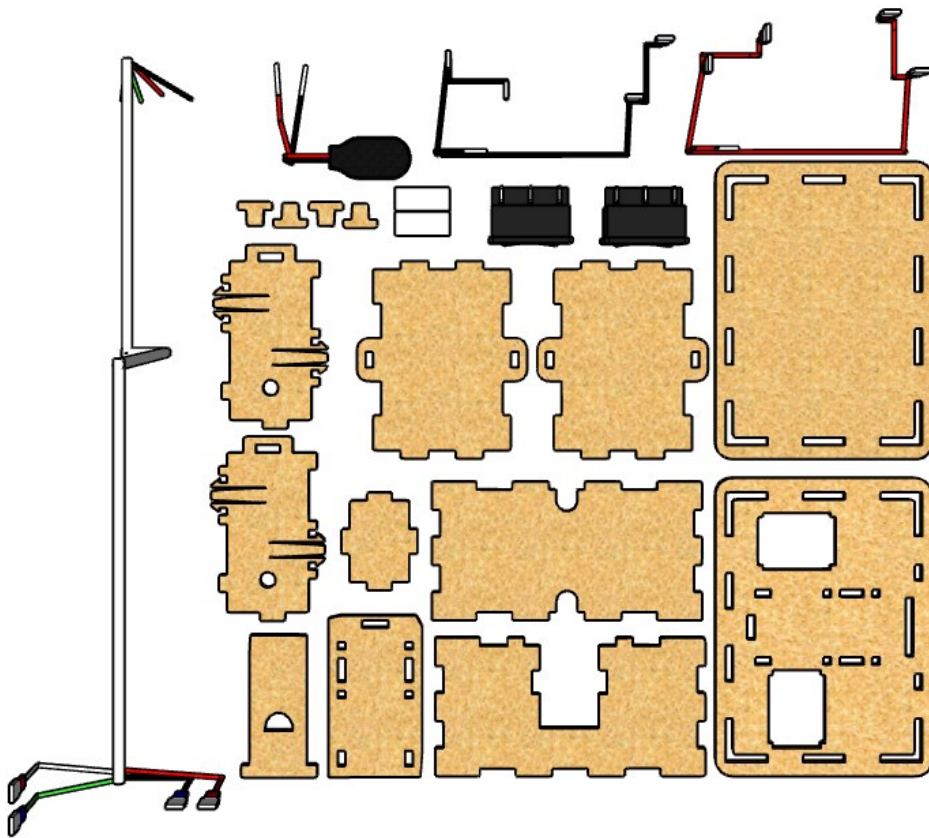

## Piezas para el control

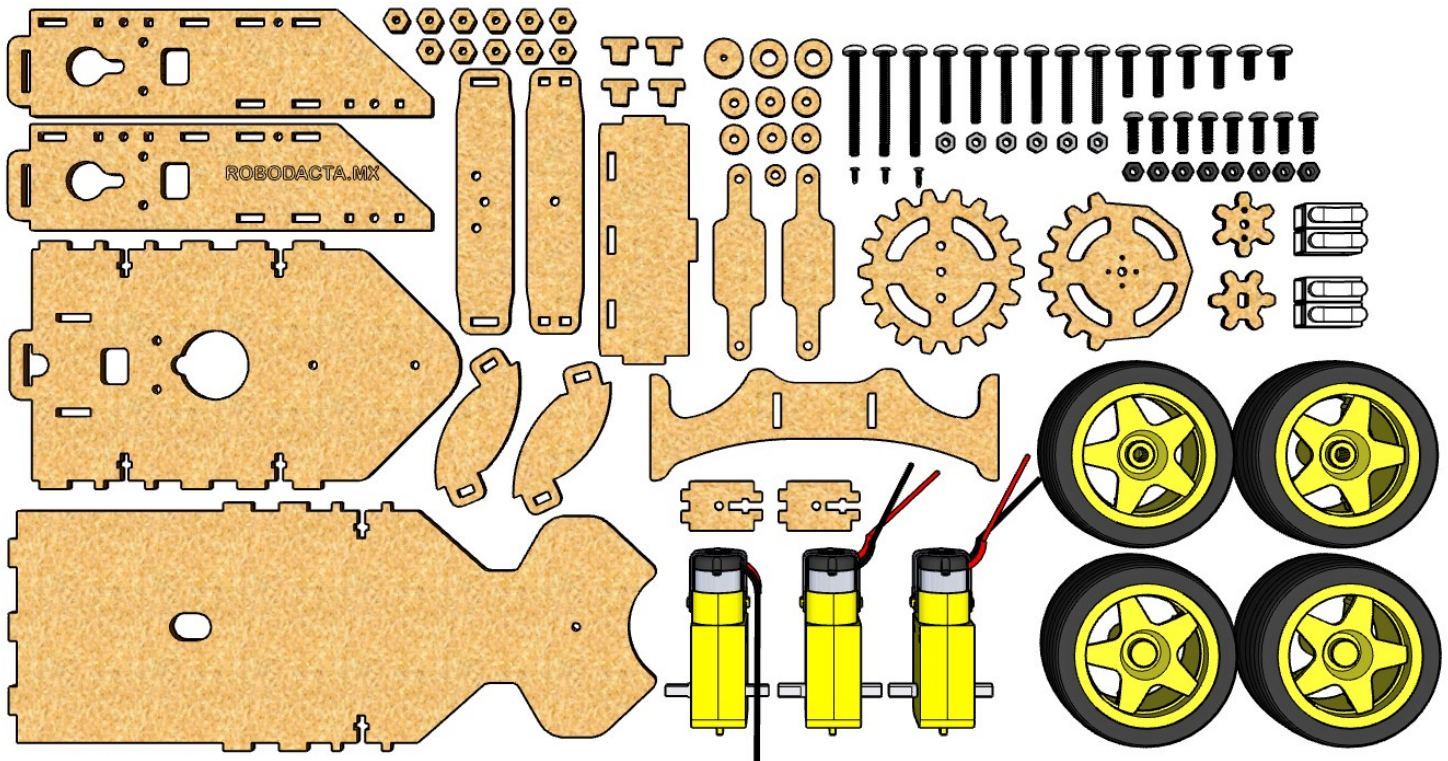

## Piezas para el carro

# Armado del control

1

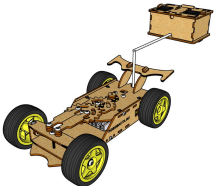

x2

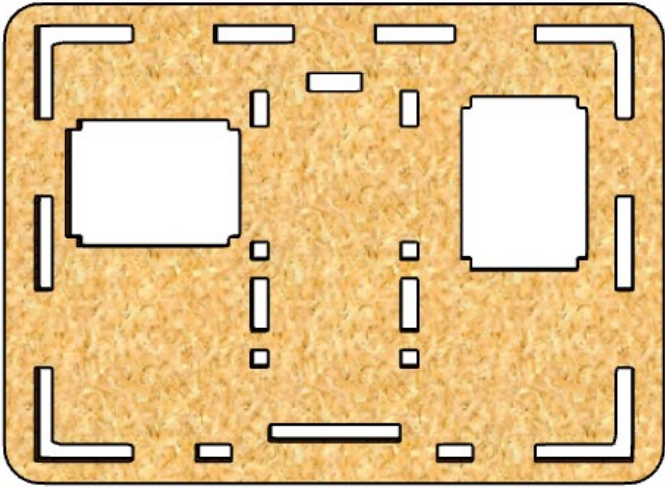
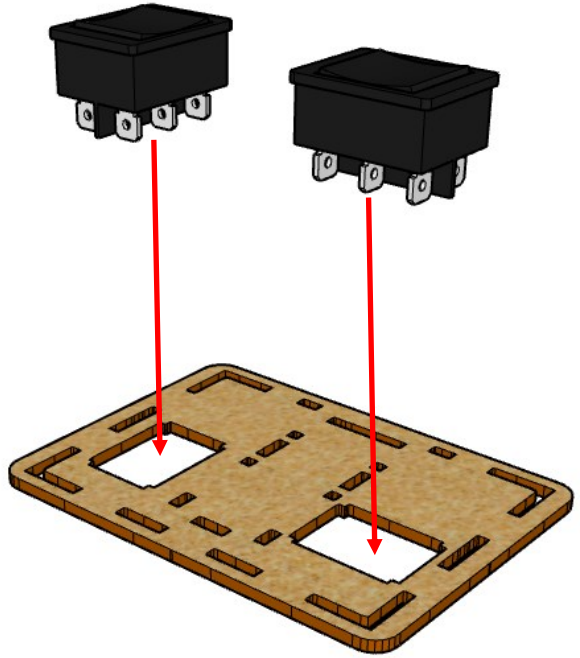

2

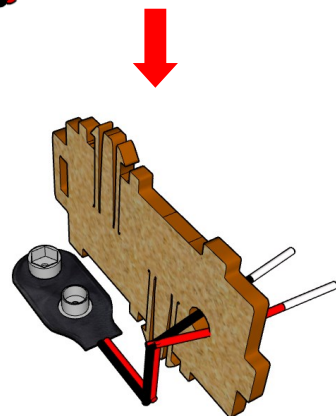
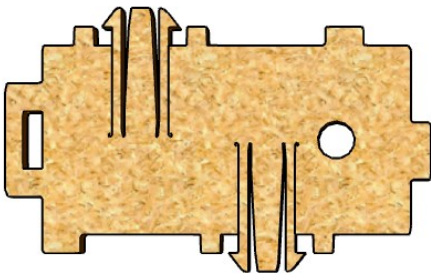
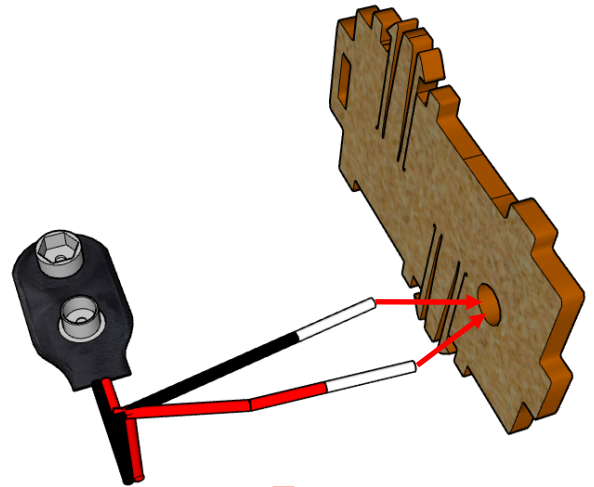
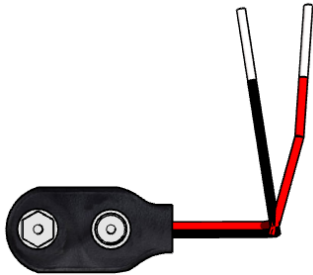
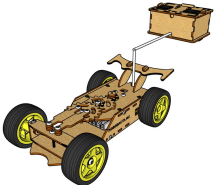

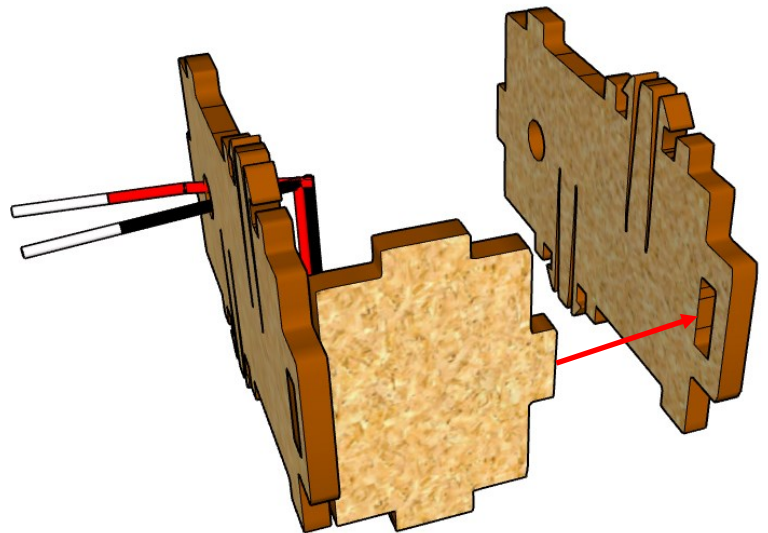
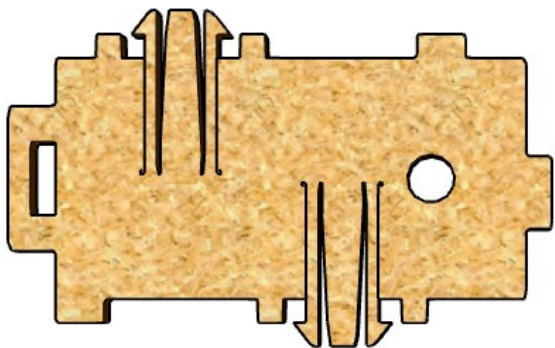
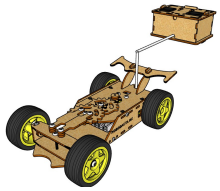
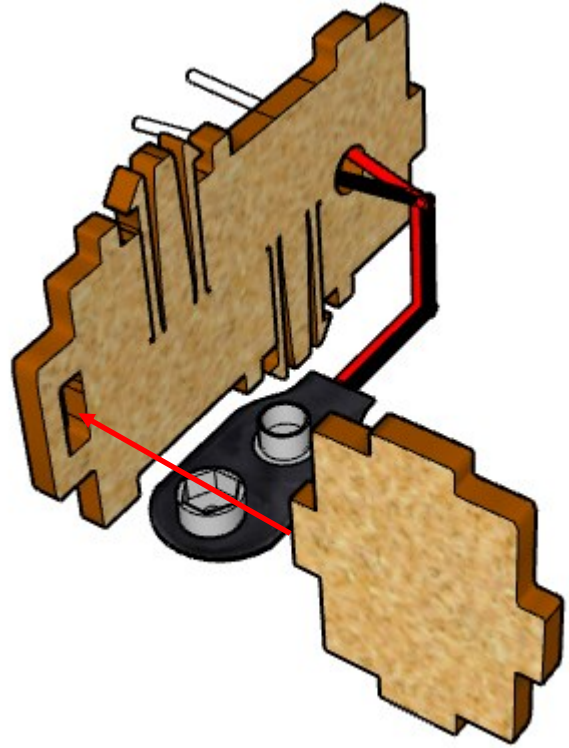
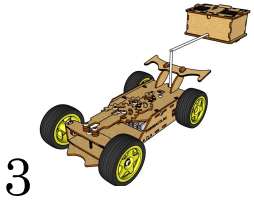

5

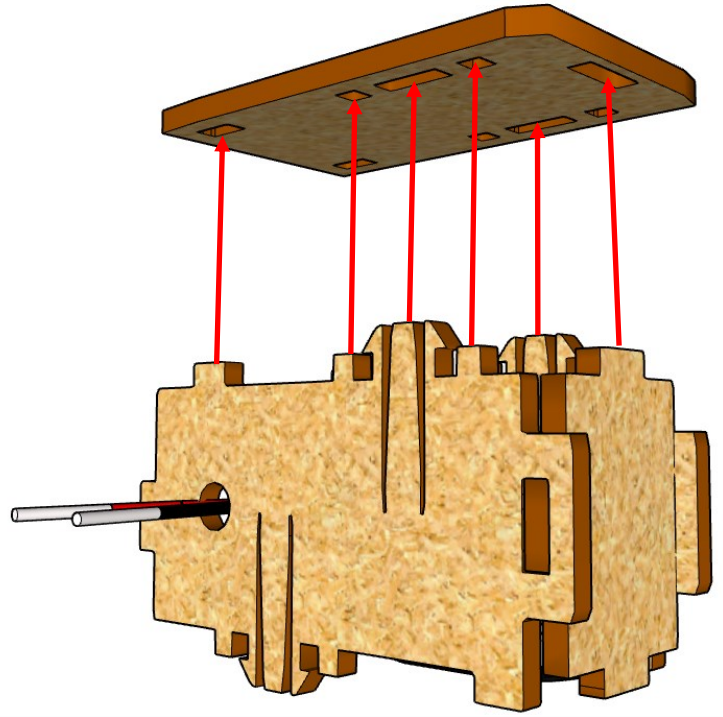
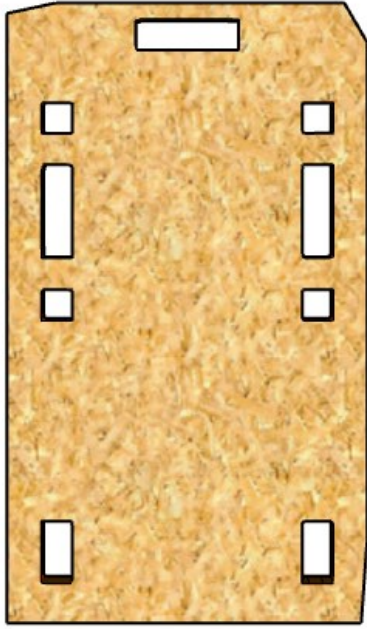
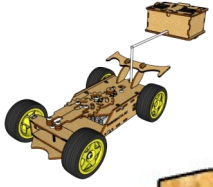

6

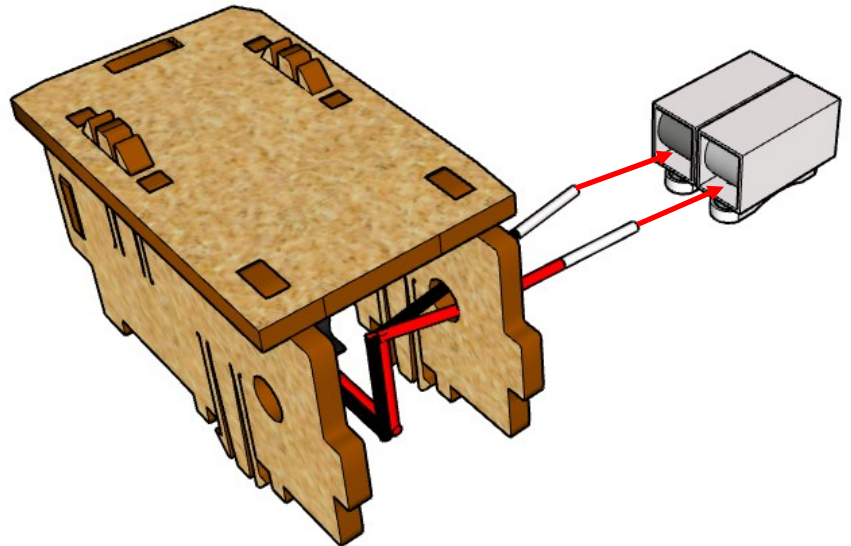
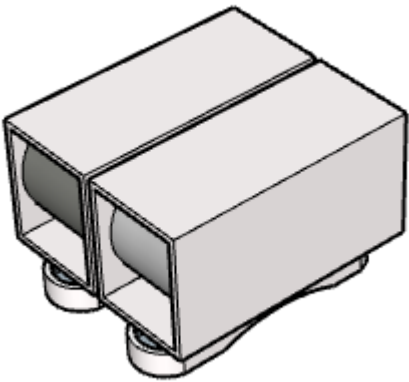
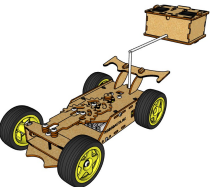

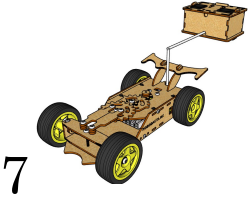

7

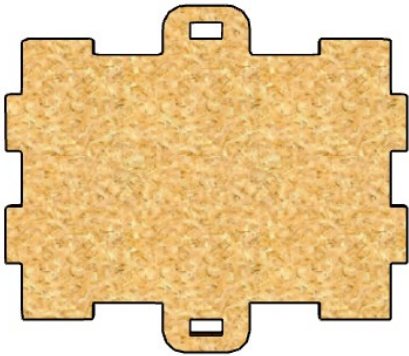
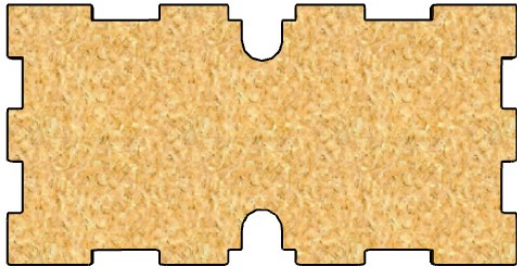

x2

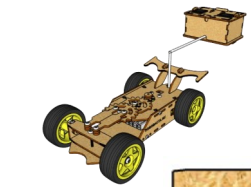
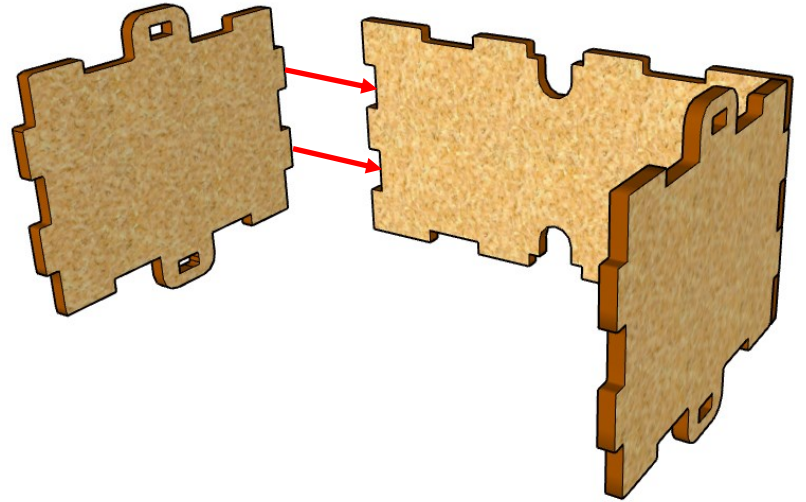
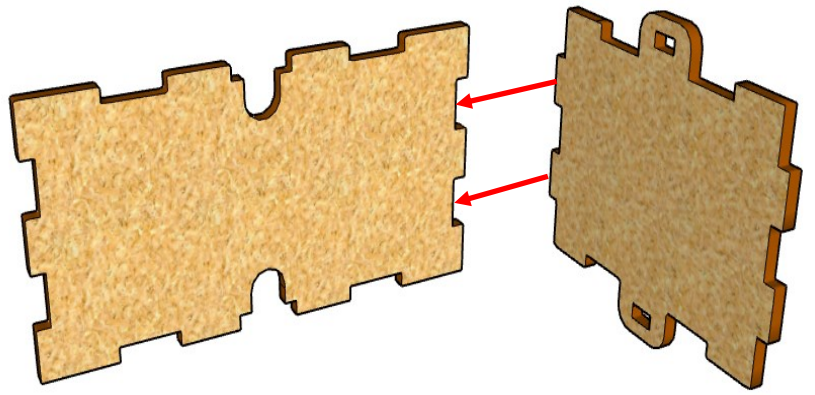

8

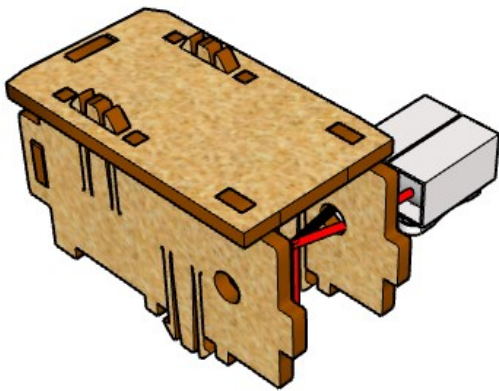
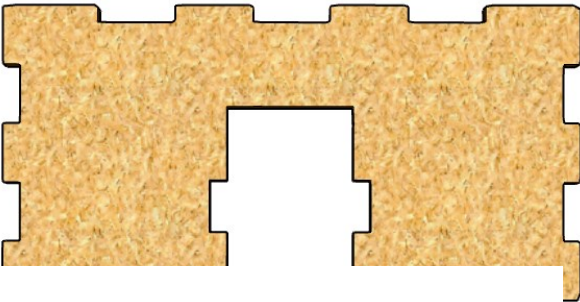

x1

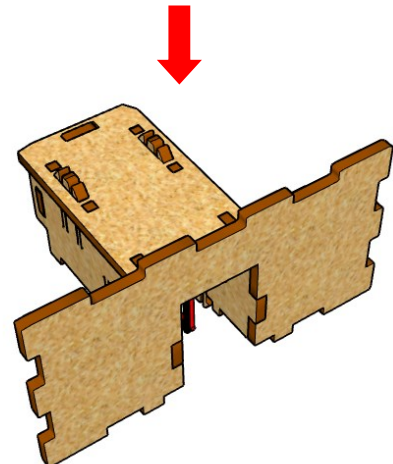
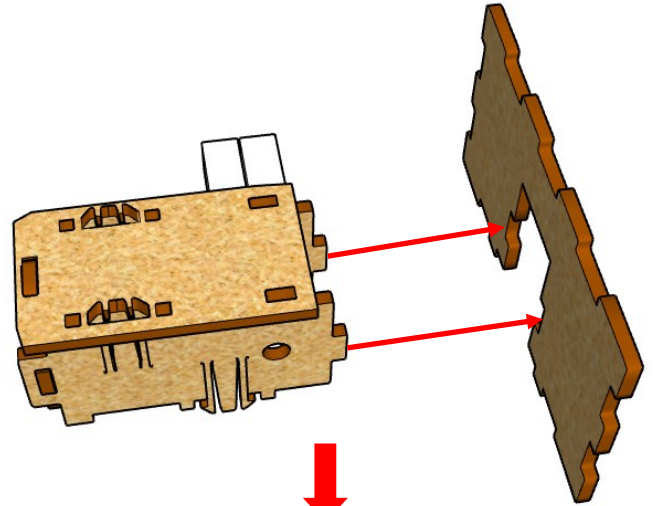

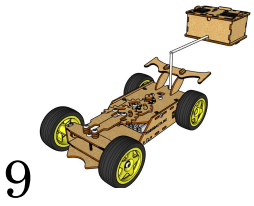

9

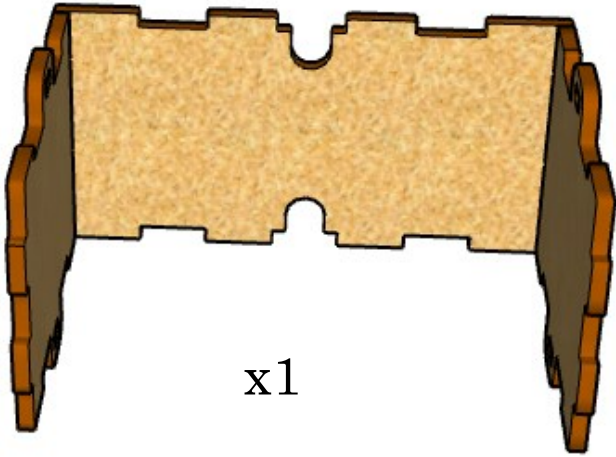

x1

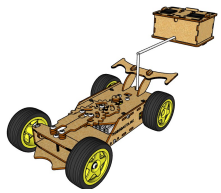
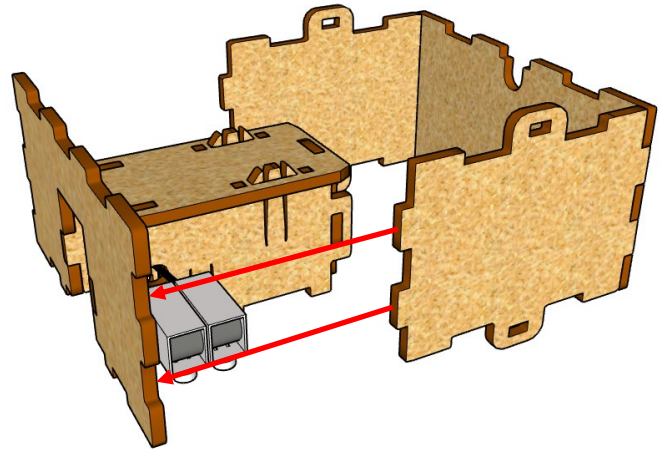
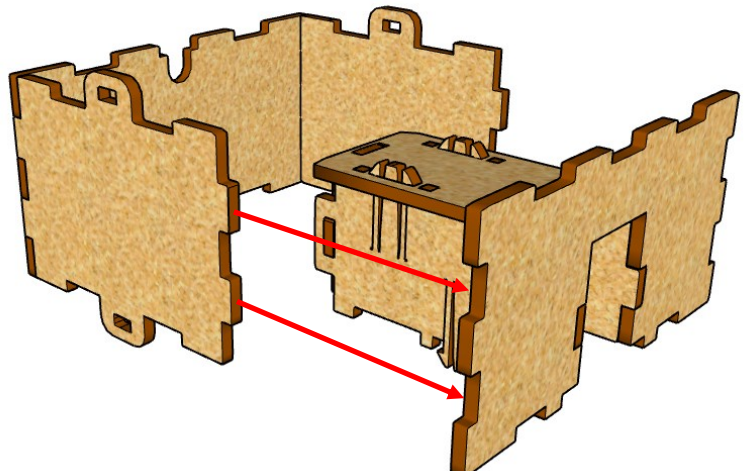

10

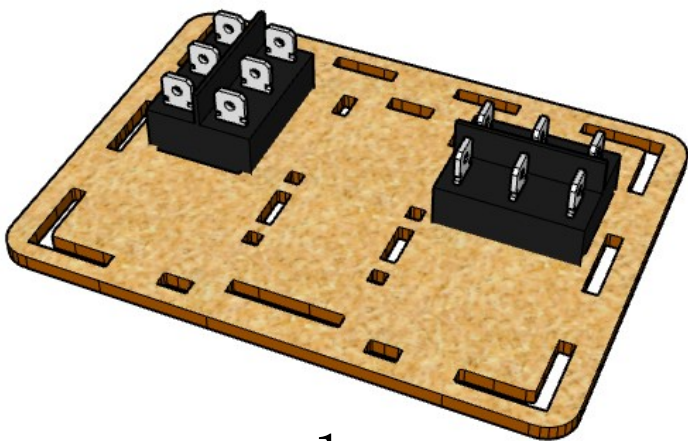

x1

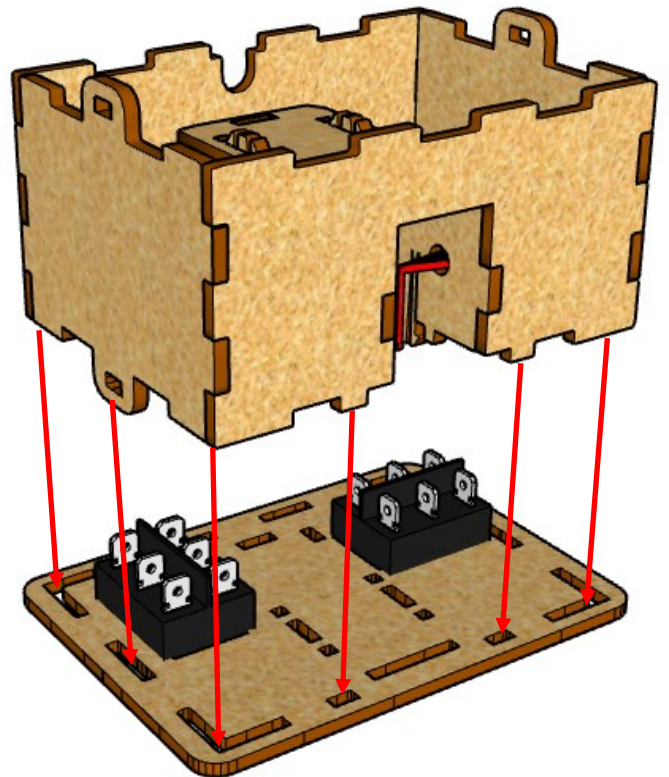

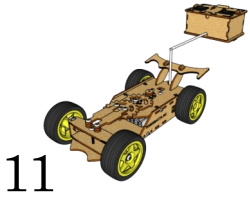

11



x2

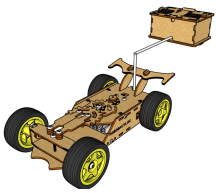
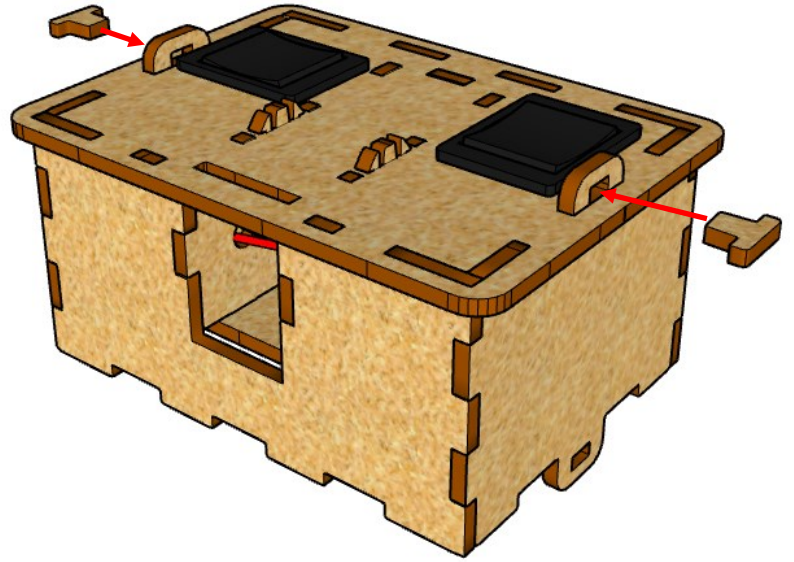

12

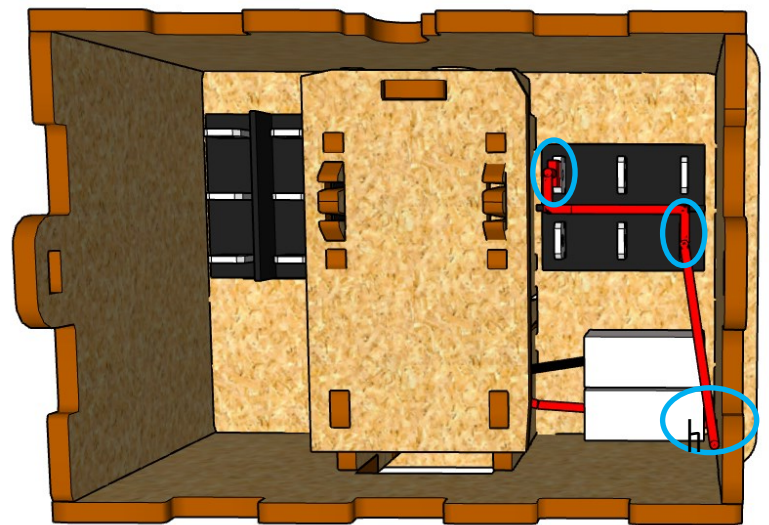
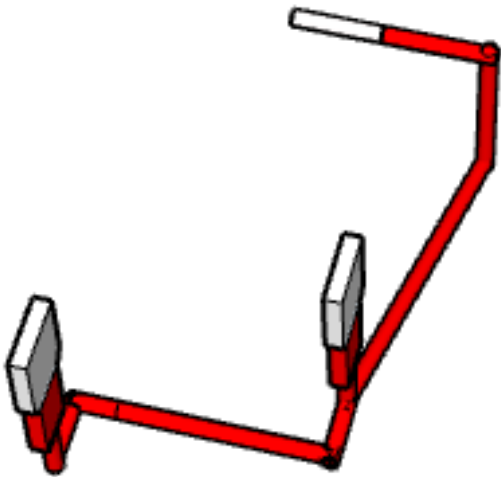

Realiza las siguientes conexiones

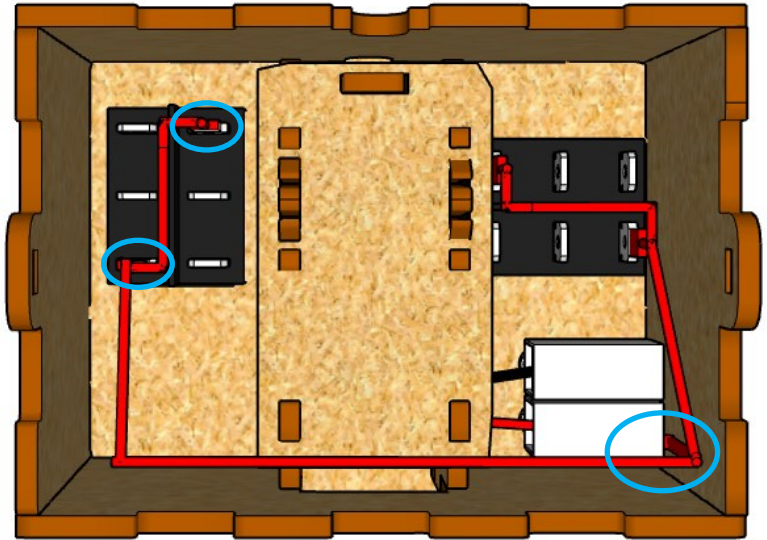
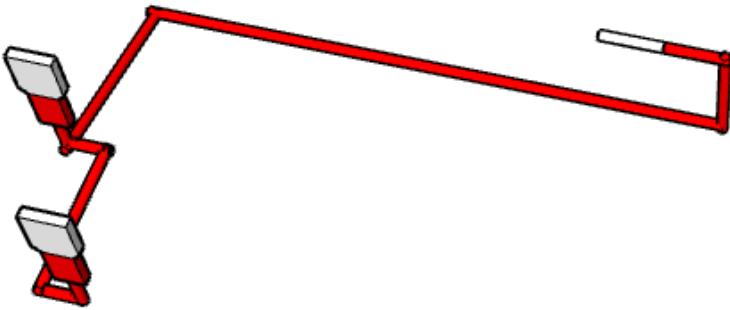
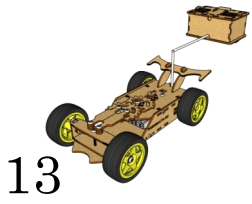

Realiza las siguientes conexiones

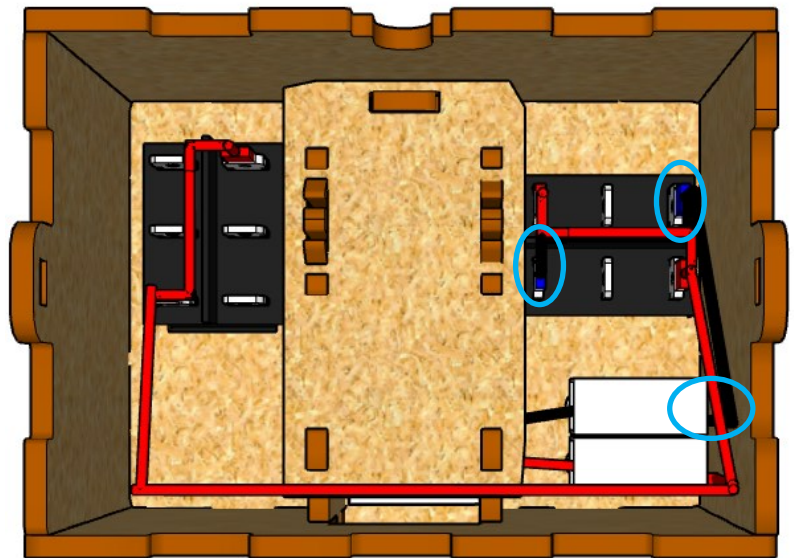
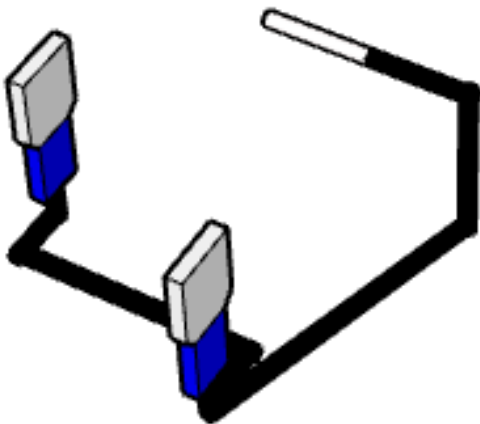

Realiza las siguientes conexiones

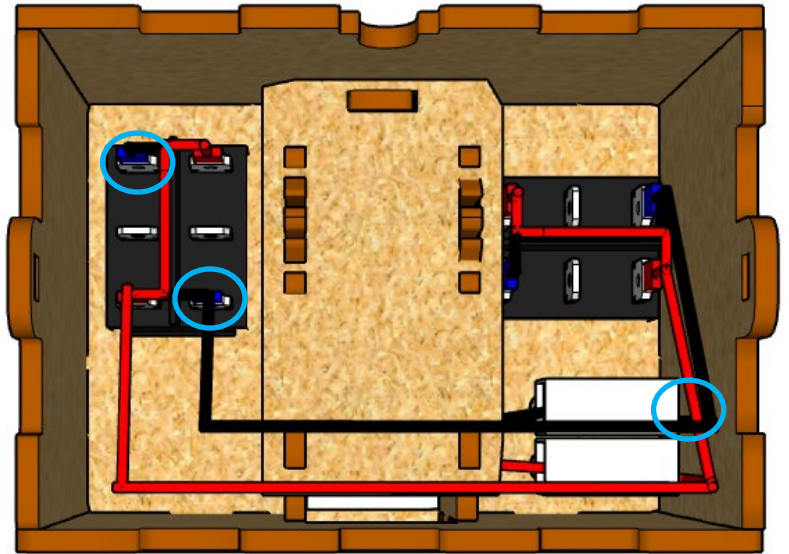
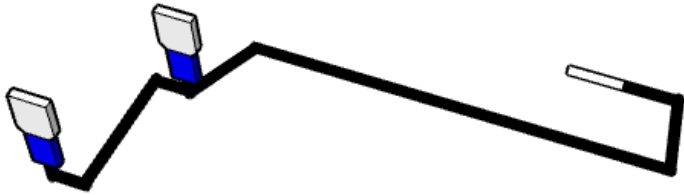
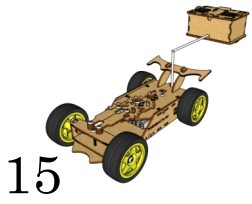

Realiza las siguientes conexiones

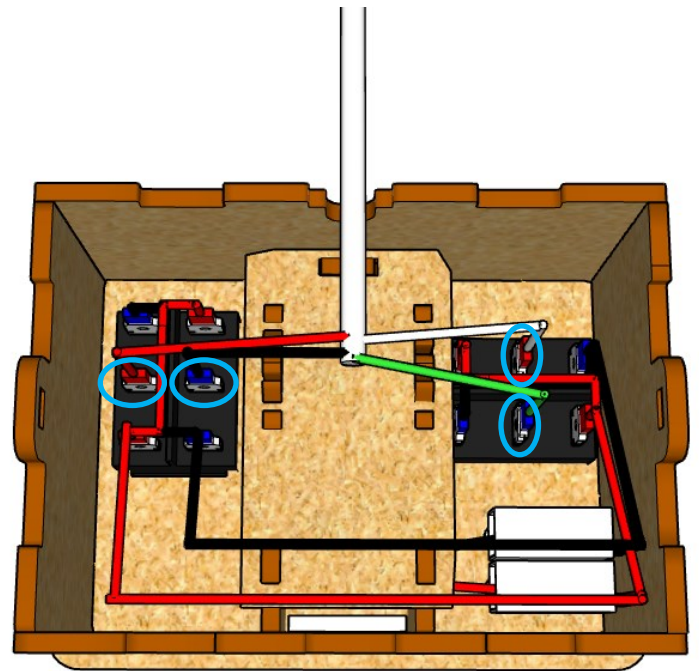
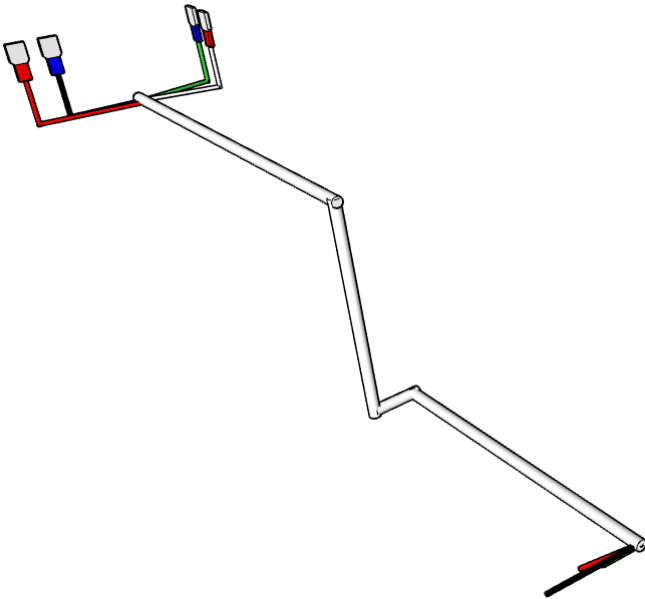
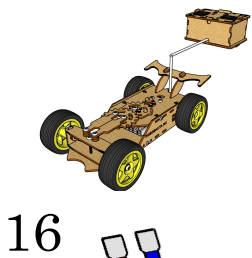

Realiza las siguientes conexiones

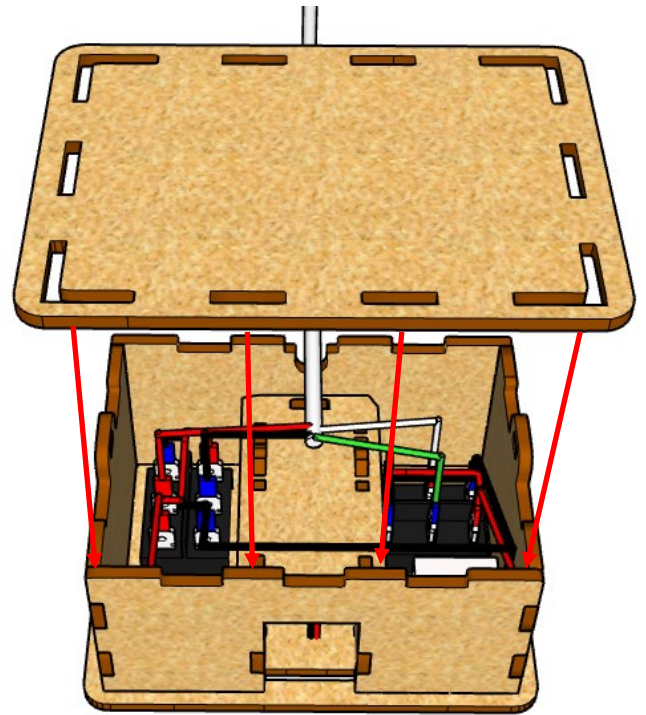
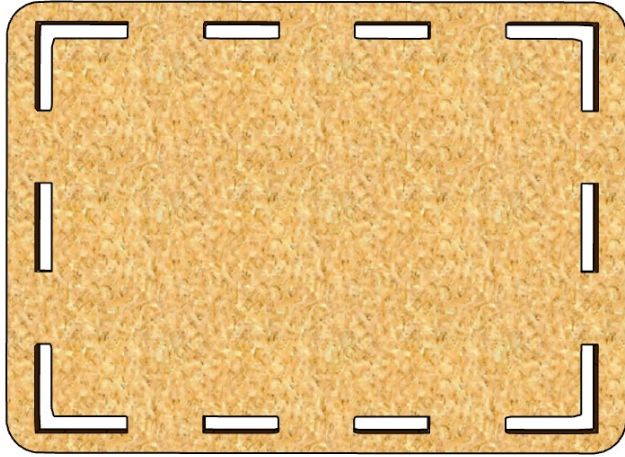
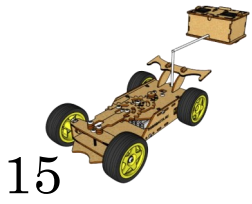

x2

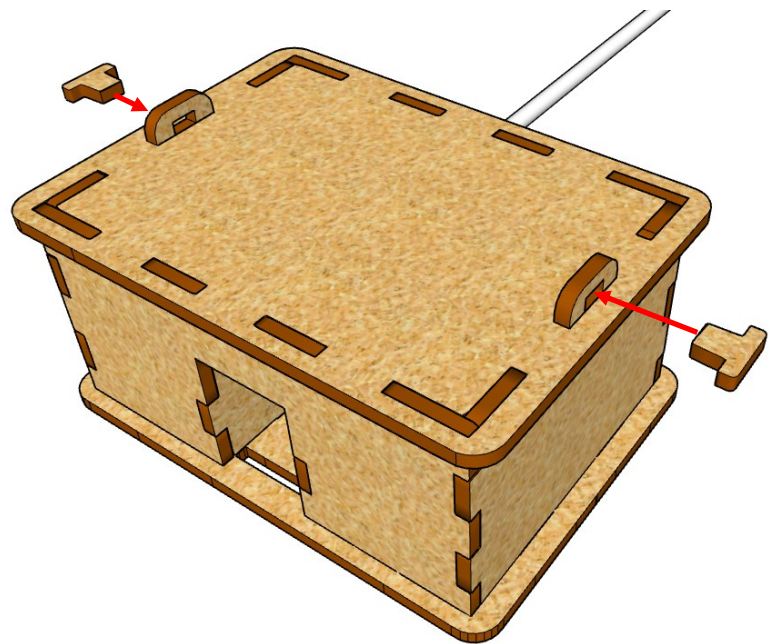

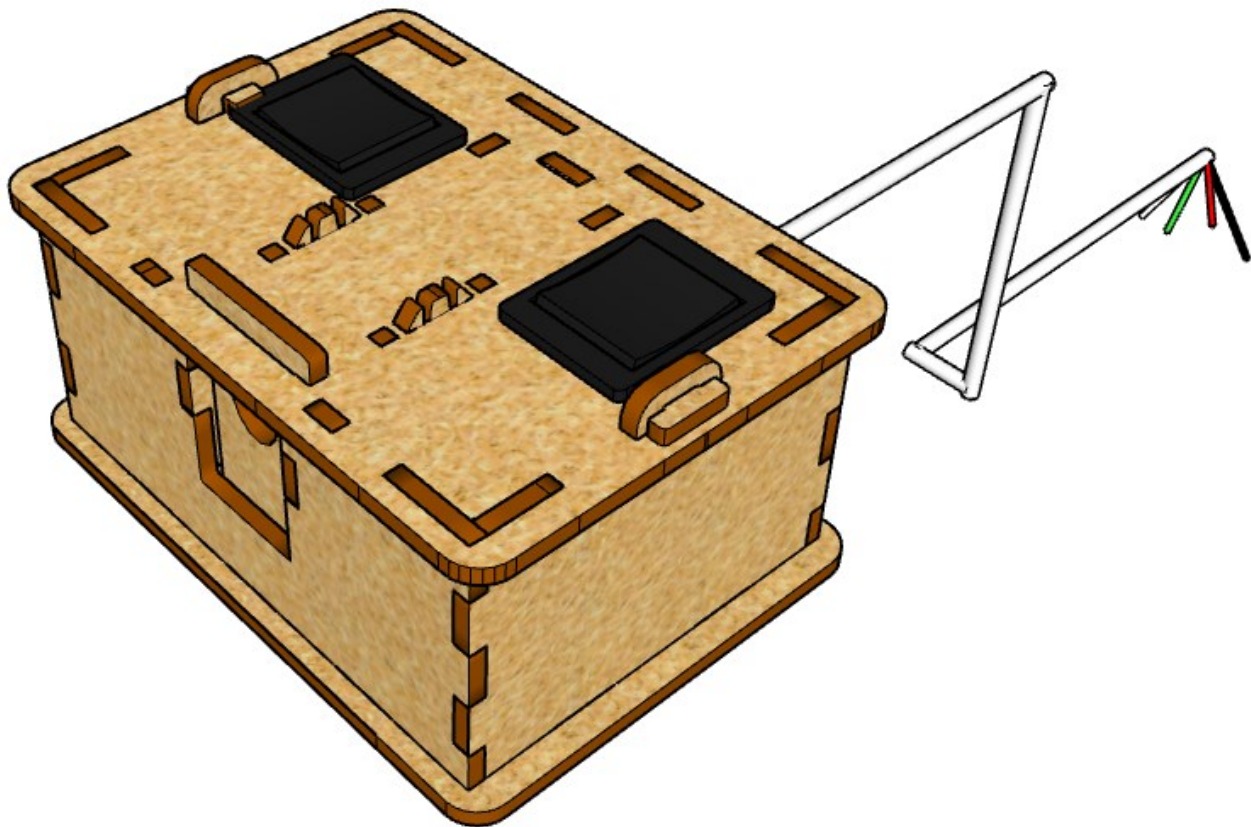
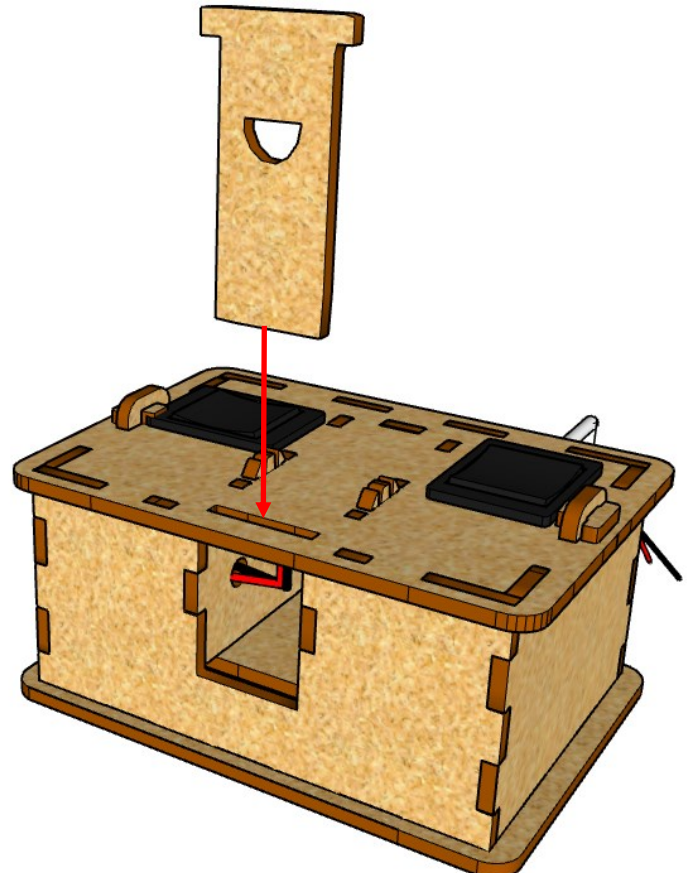
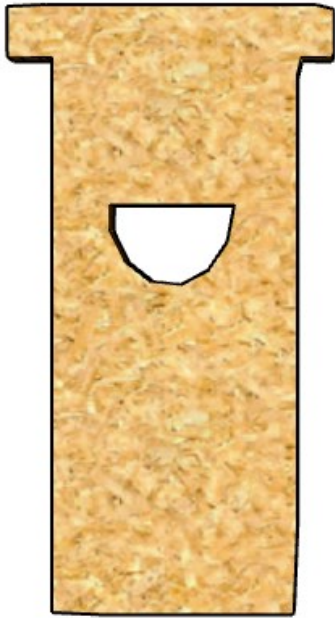
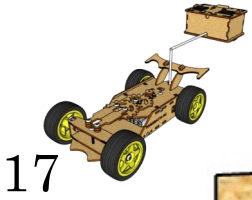

*Armado del carro*

18

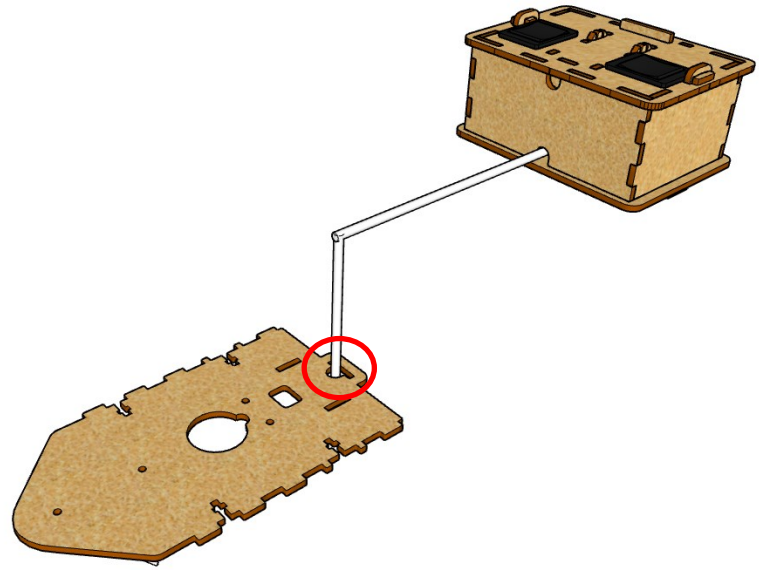
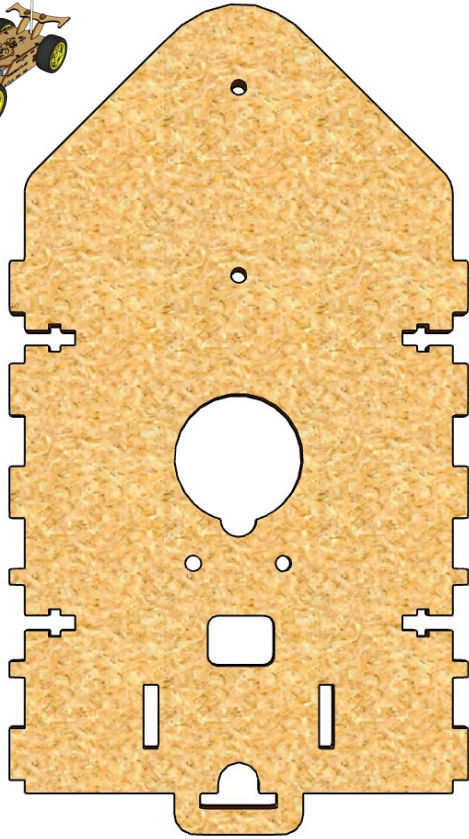
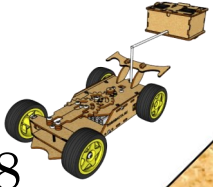

Pasa el cable blanco a través de este orificio

19

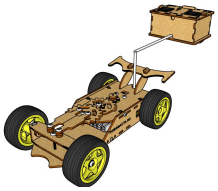

Tornillo de 2.7 cm

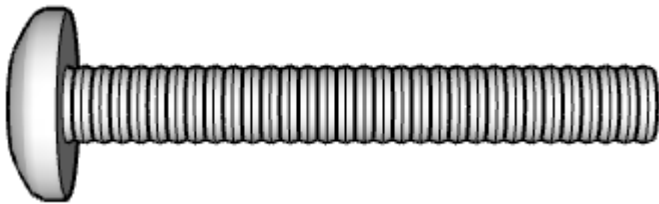

x2

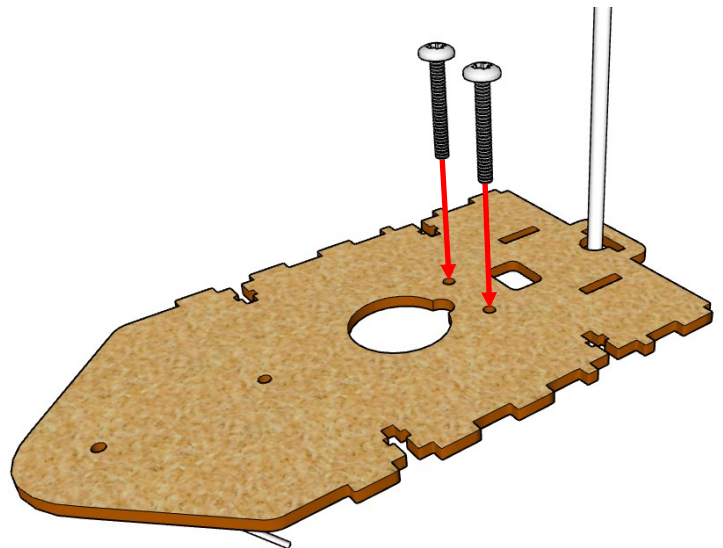

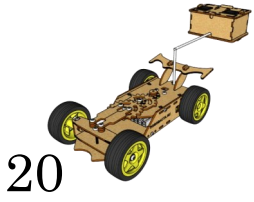

20

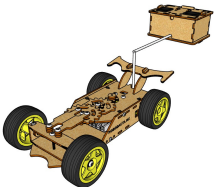
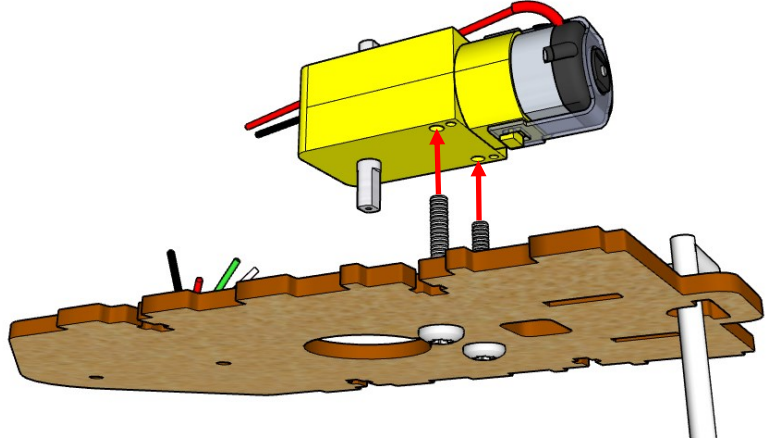
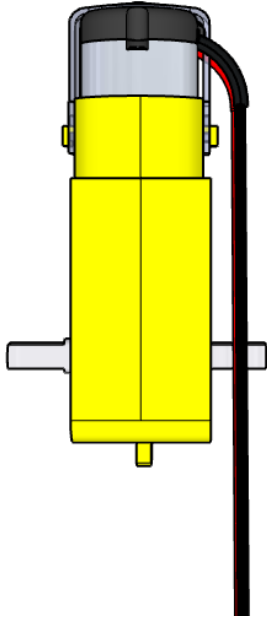

21

Tuerca metálica grande

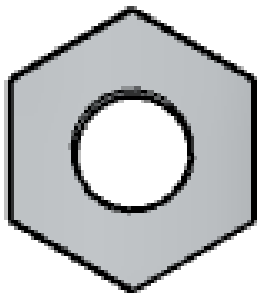

x2

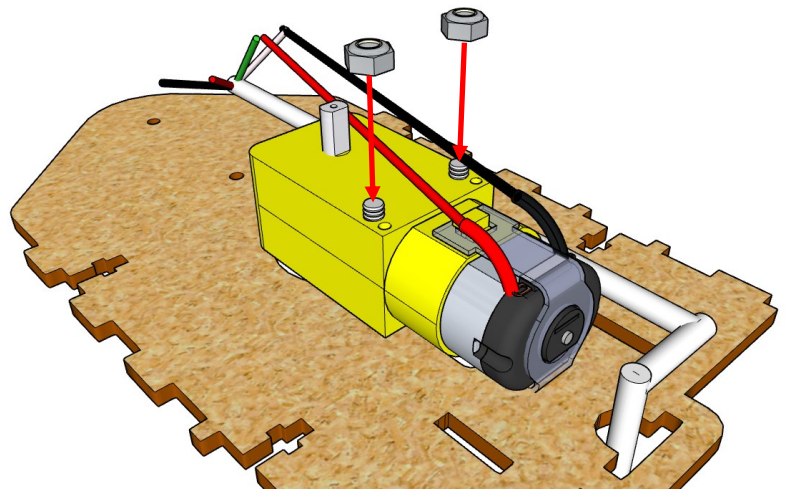

22

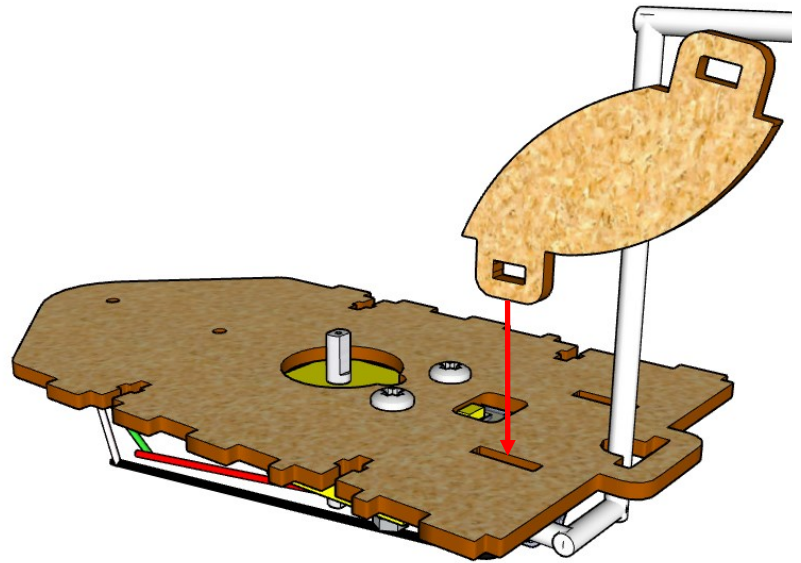
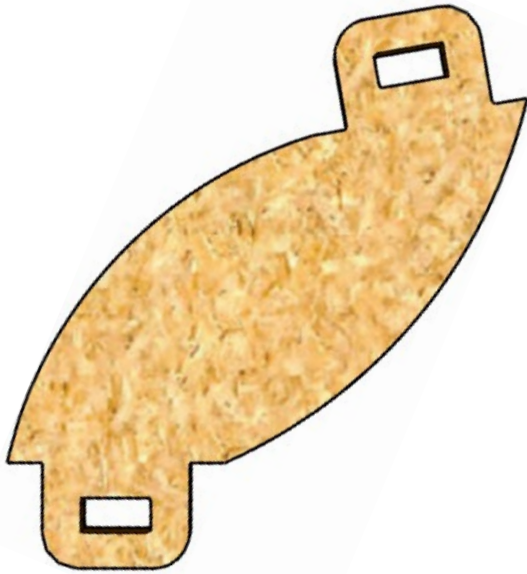

23

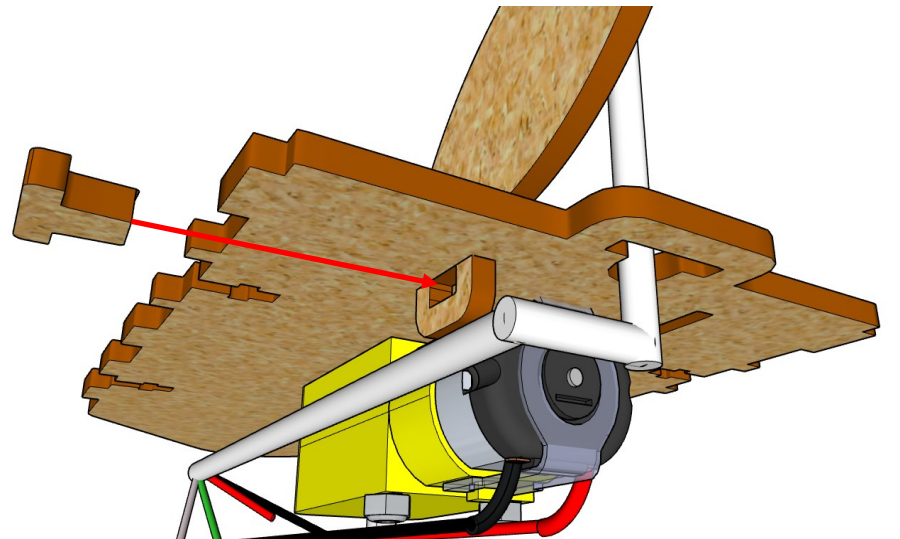
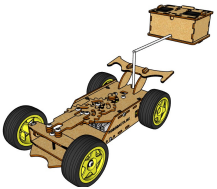

24

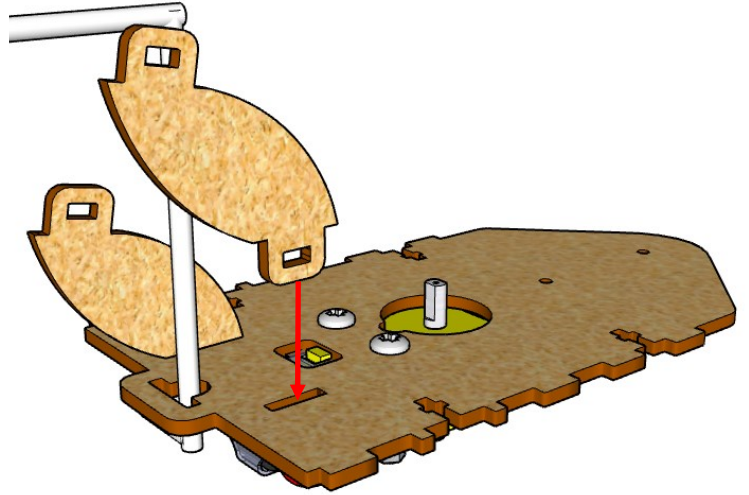
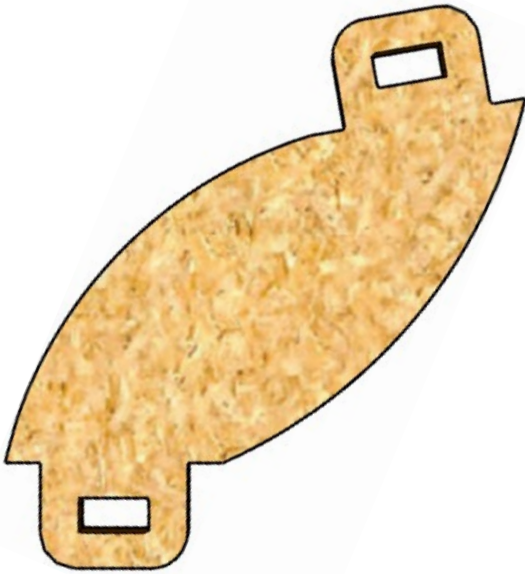
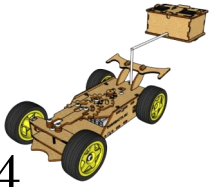

25

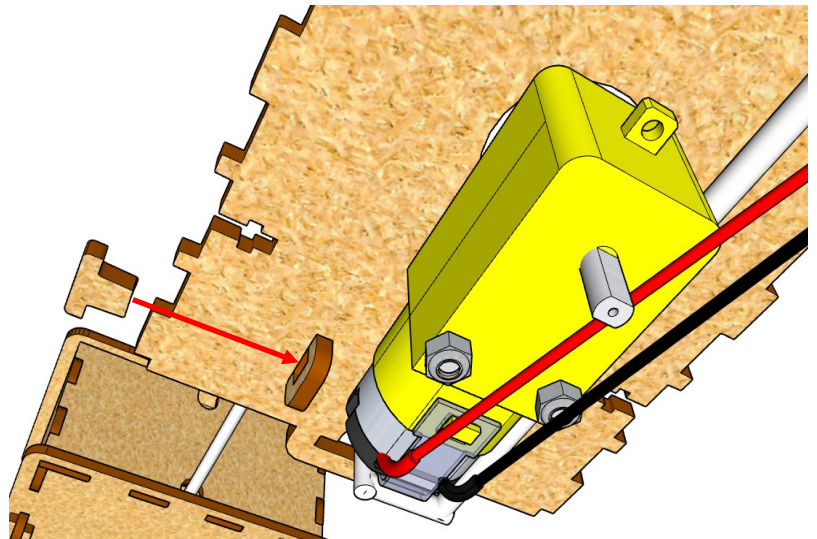
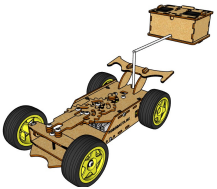

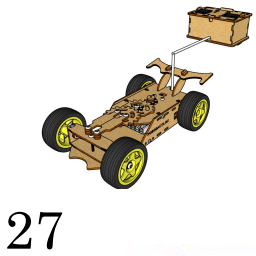
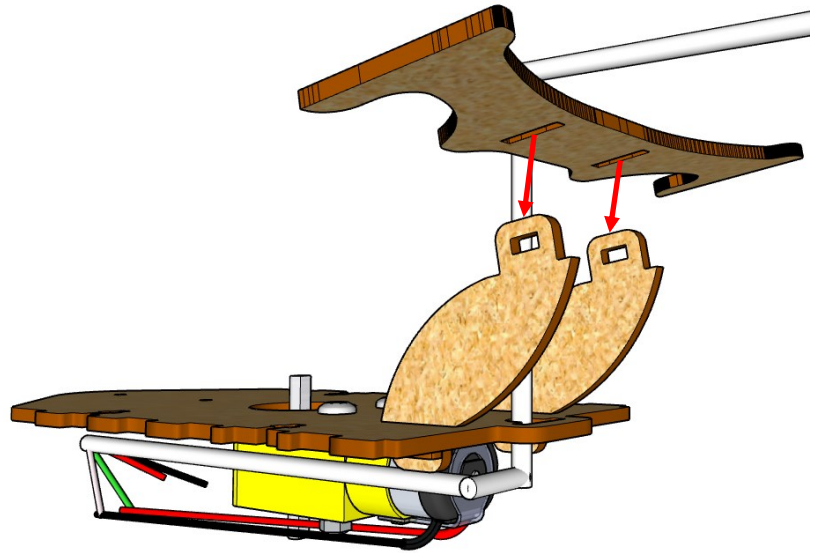
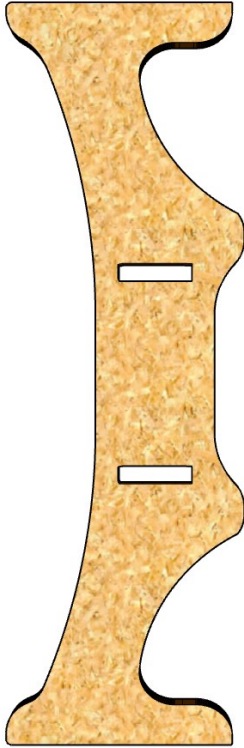
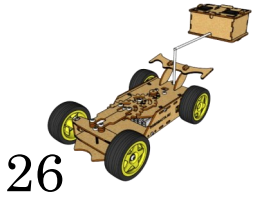

x2

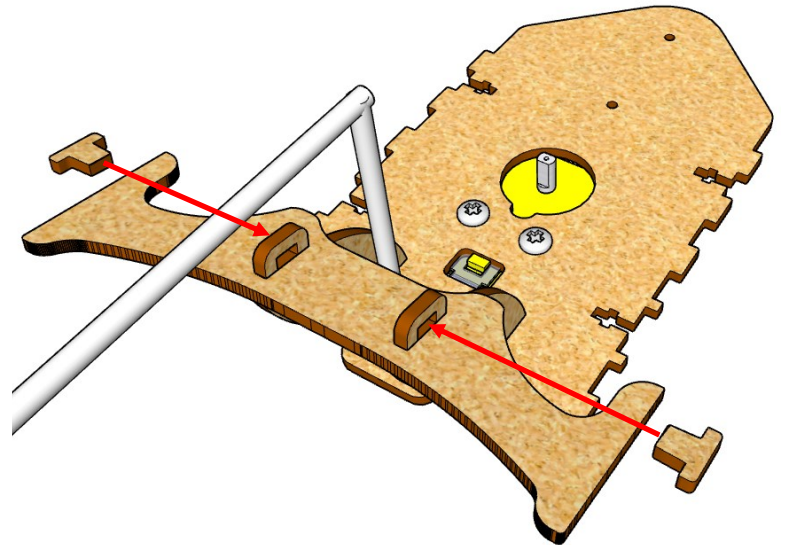

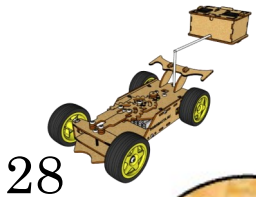

28



Tornillo de 1 cm

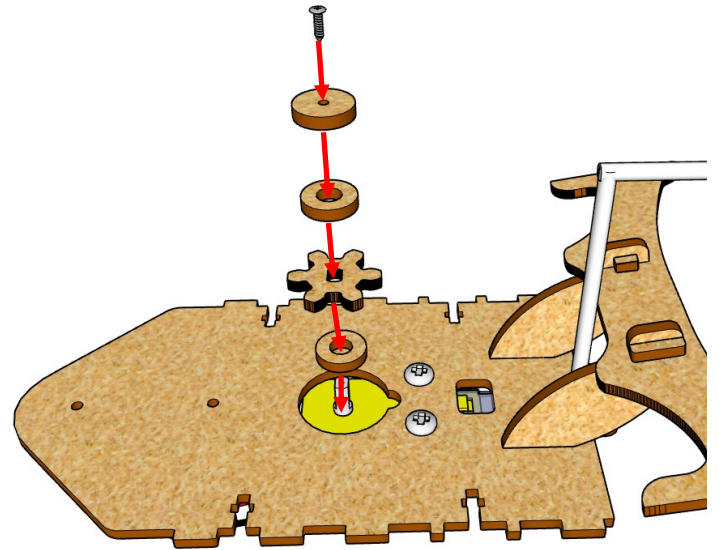
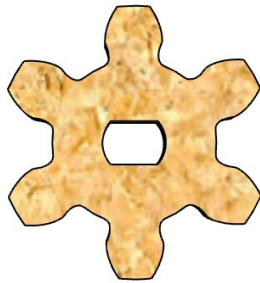

x2

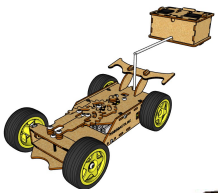

29



Tornillo de 0.6 cm

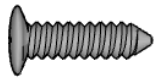

x2

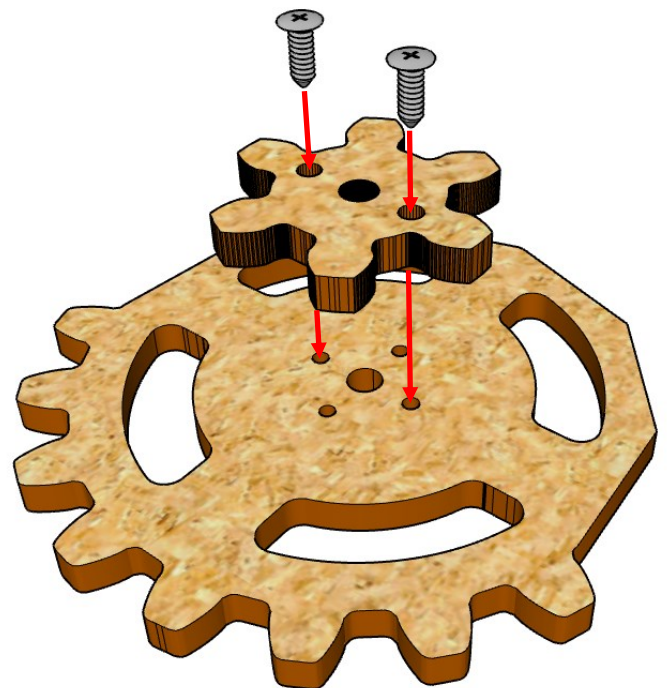
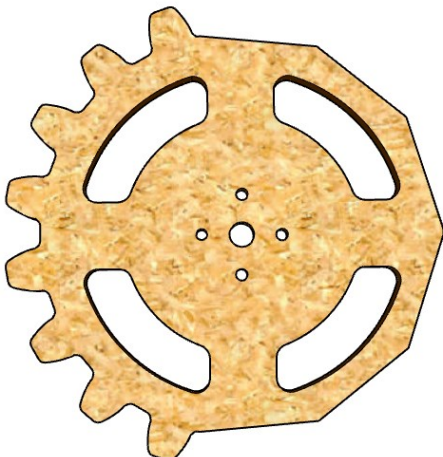

30

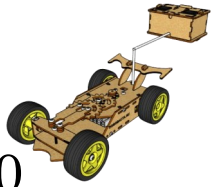

Tornillo de 1.5

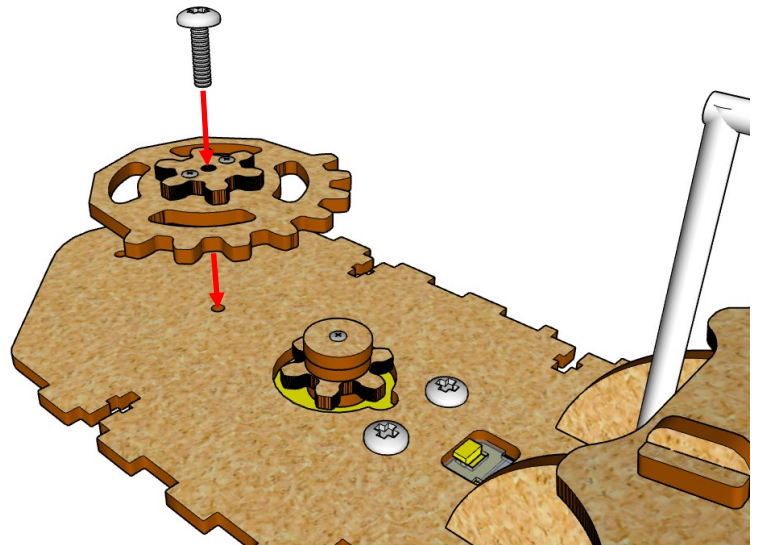
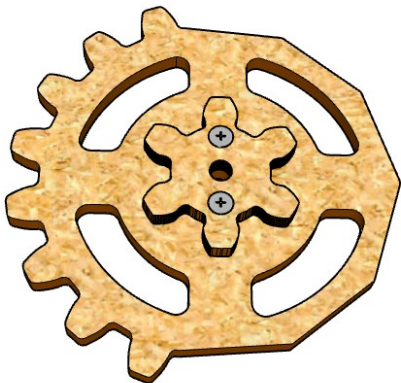
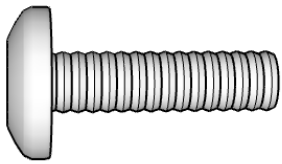

Nota: Asegúrese de que los engranes estén en la siguiente posición.

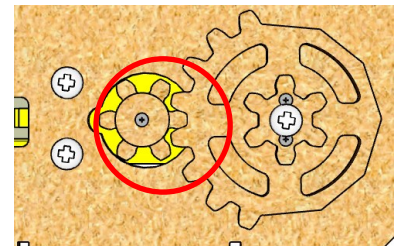

31

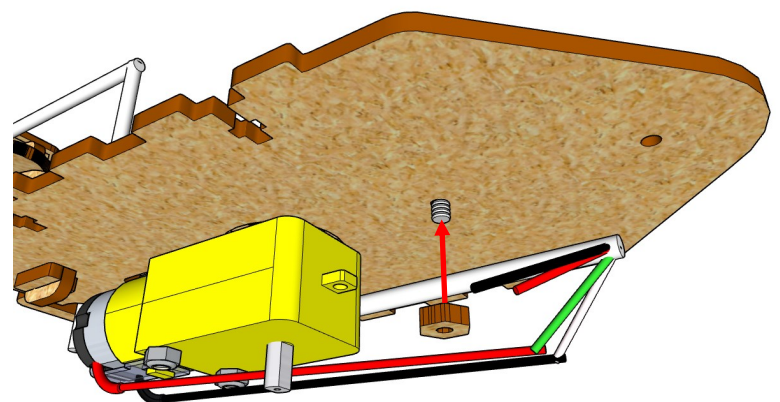
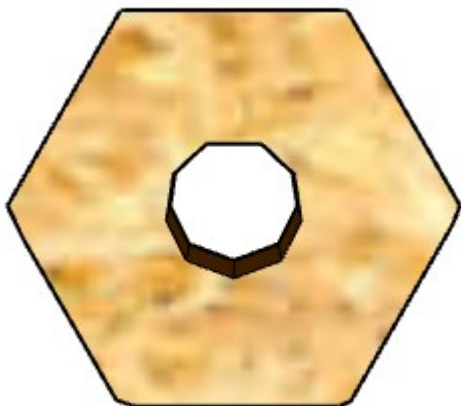
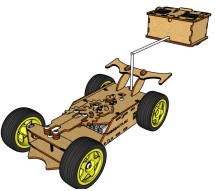

*Nota: al colocar la tuerca de MDF ajusta asta el tope y regresa 1/2 de vuelta.*

32

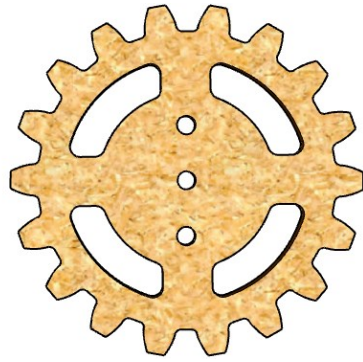
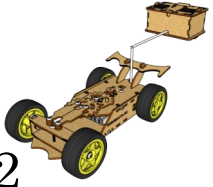

Tornillo de 1.1 cm

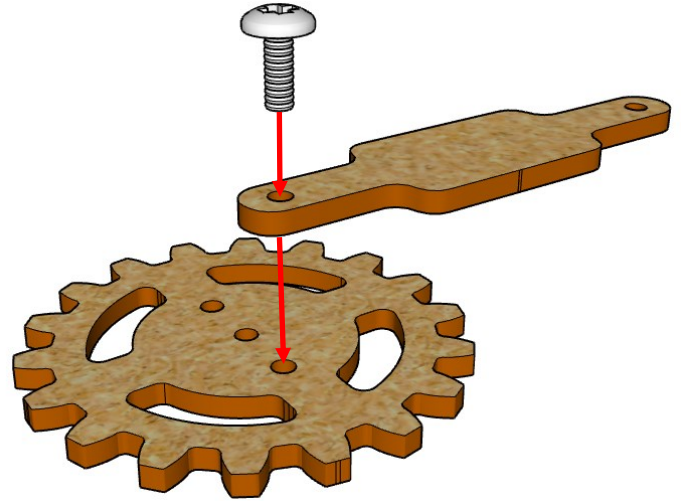
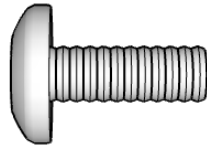

33

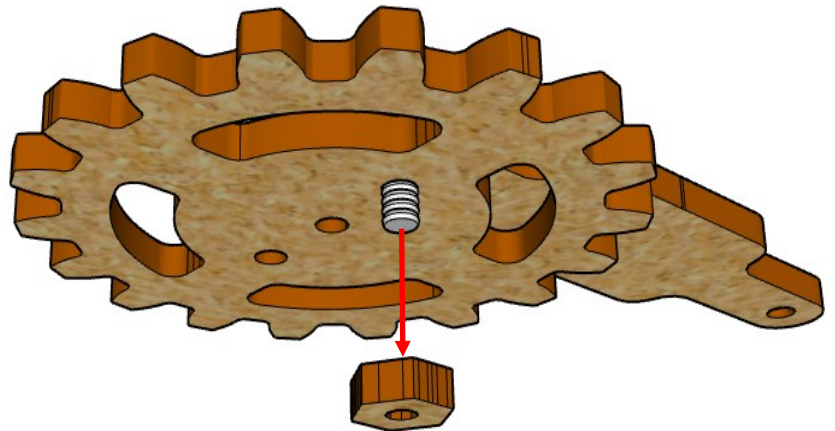
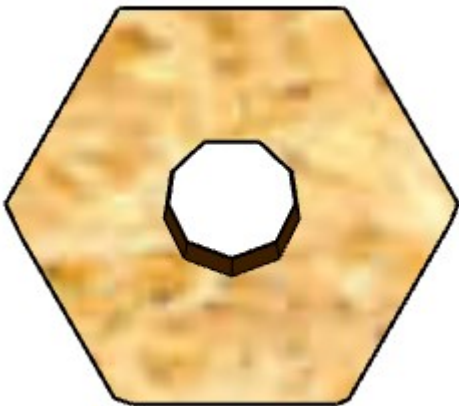
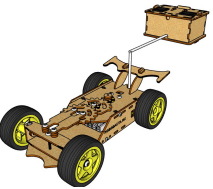

*Nota: al colocar la tuerca de MDF ajusta asta el tope y regresa 1/2 de vuelta.*

34

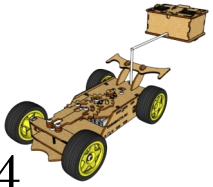

Tornillo de 1.1 cm

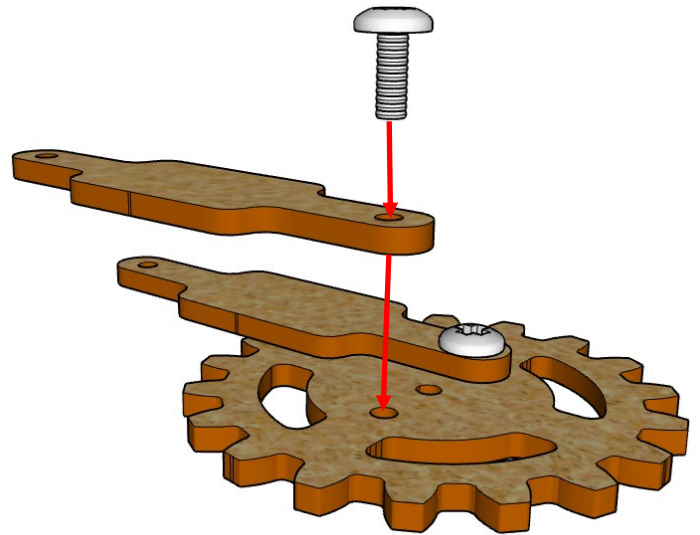
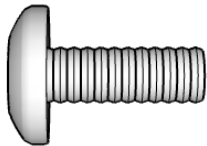

35

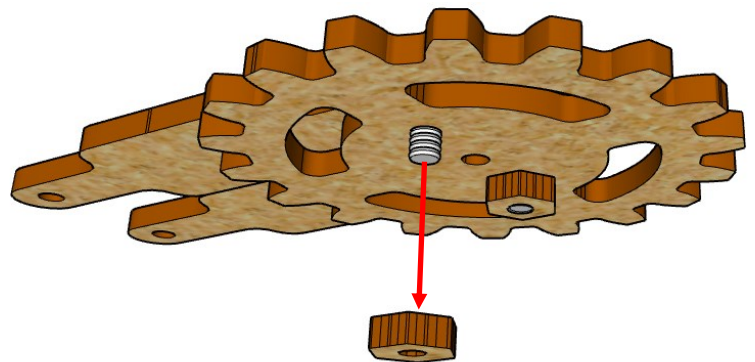
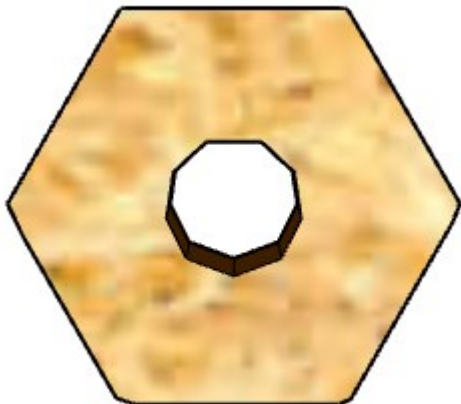
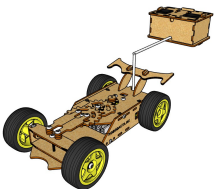

*Nota: al colocar la tuerca de MDF ajusta asta el tope y regresa 1/2 de vuelta.*

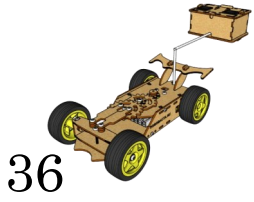

36

Tornillo de 1.5 cm

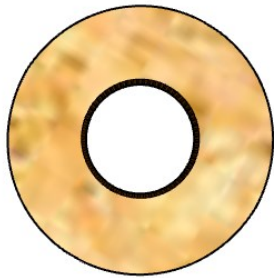
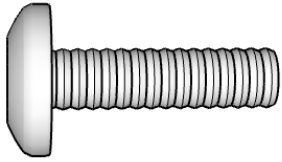

Buje pequeño

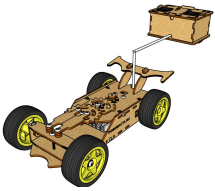
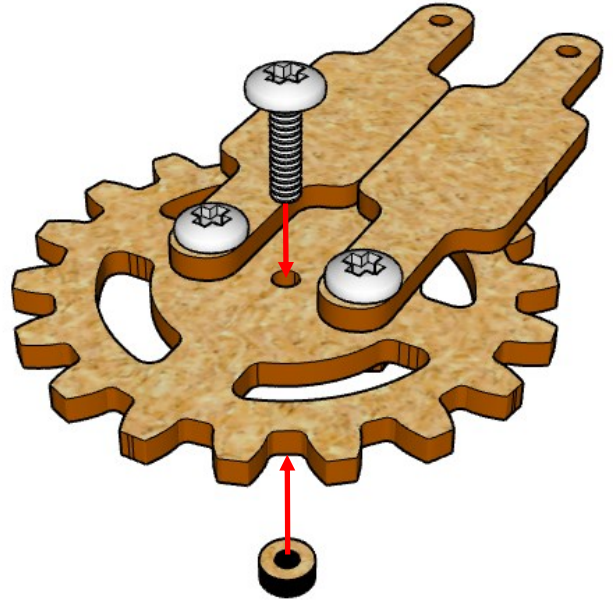

37

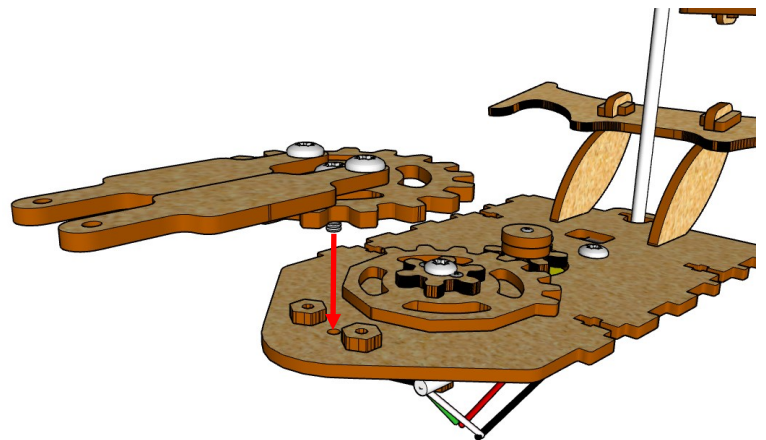
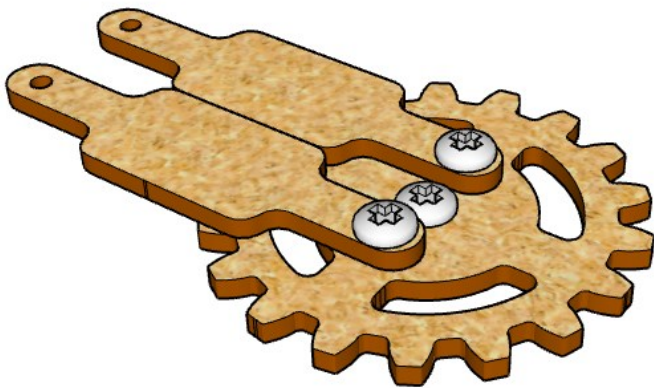

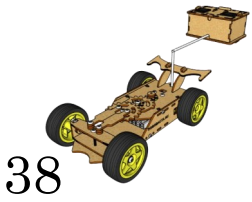

38

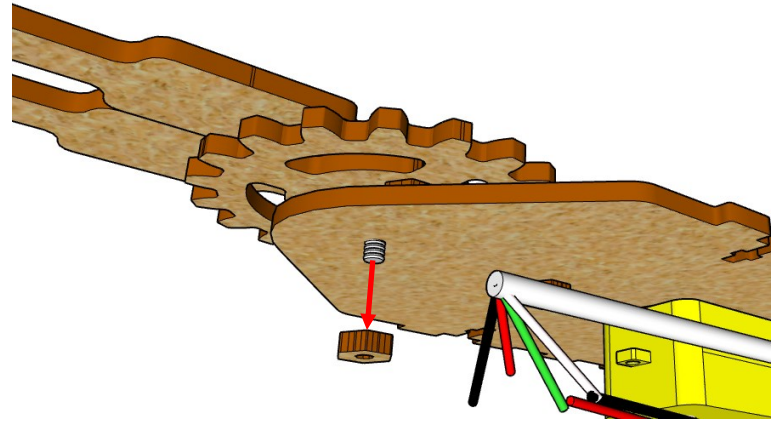
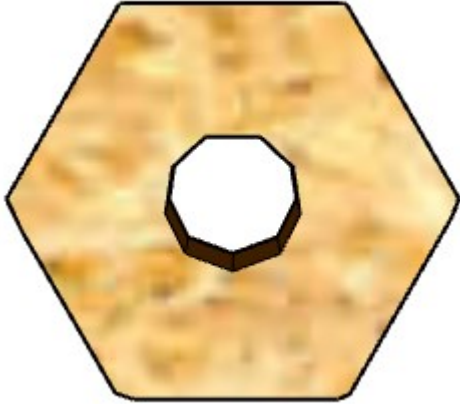

*Nota: al colocar la tuerca de MDF ajusta asta el tope y regresa 1/2 de vuelta.*

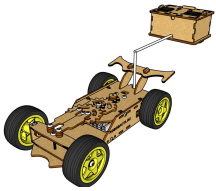

39

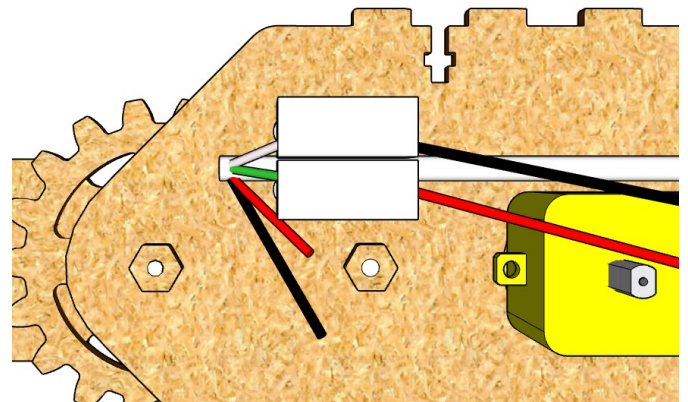
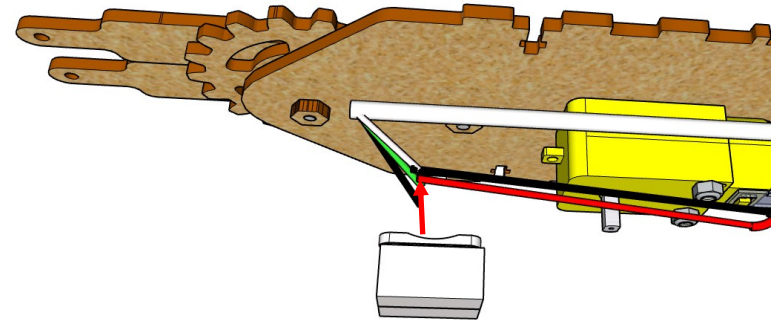
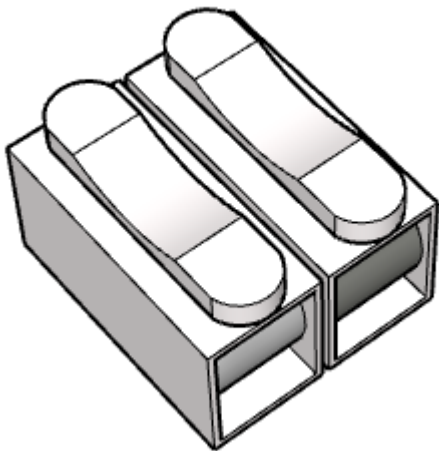

Realiza las siguientes conexiones

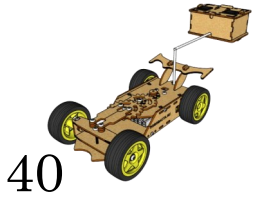

40

Tornillo de 2.7 cm



x2

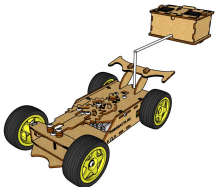
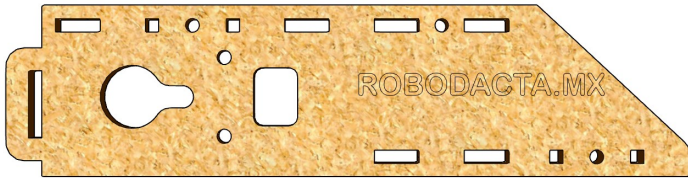
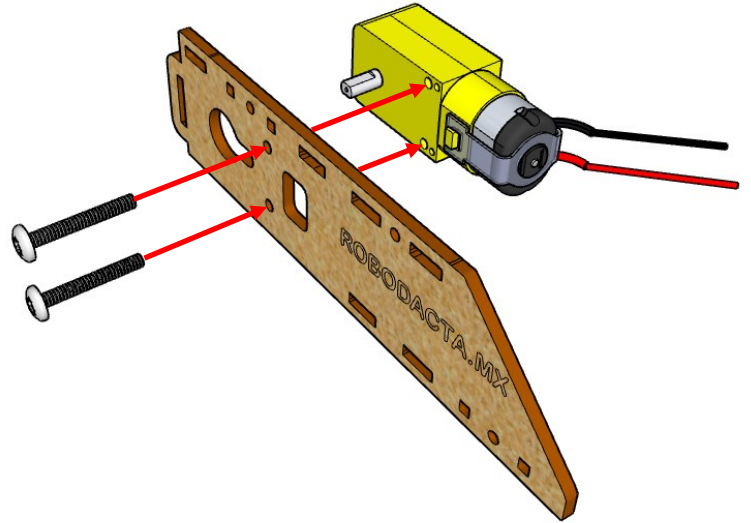
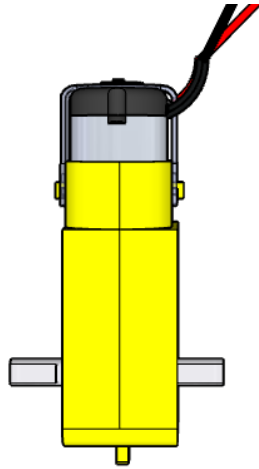

41

Tuerca metálica grande

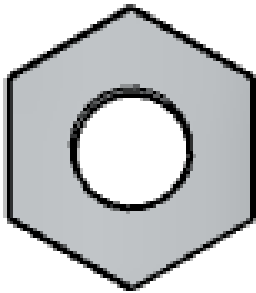

x2

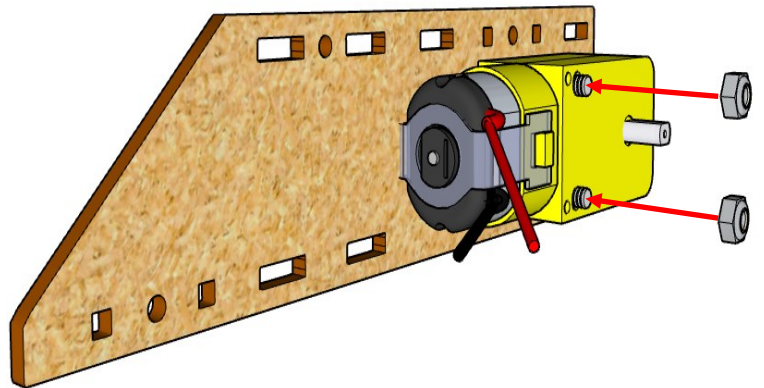

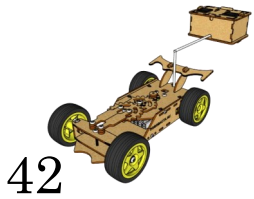

Tornillo de 2.7 cm



x2

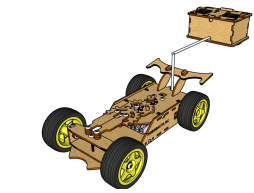
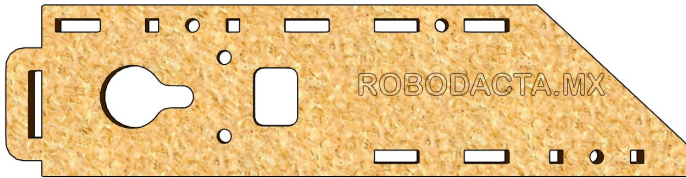
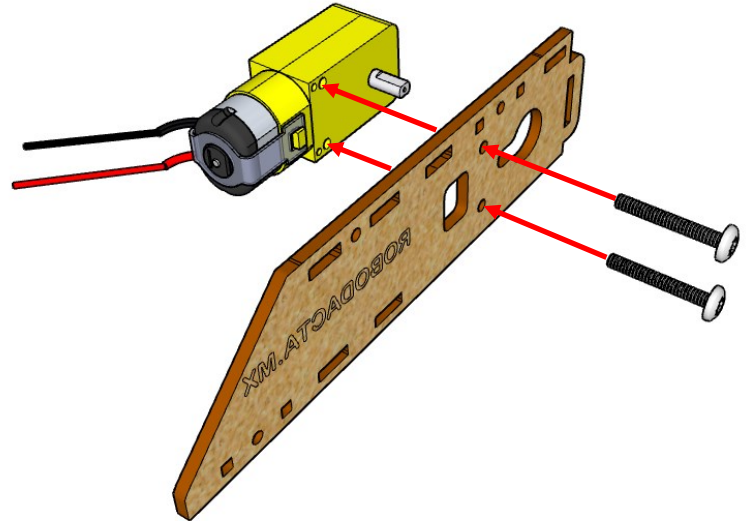
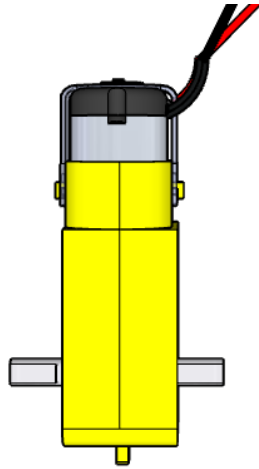

Tuerca metálica grande

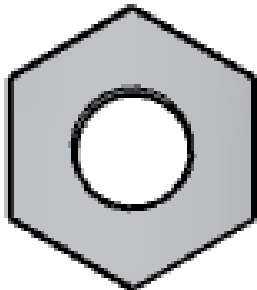

x2

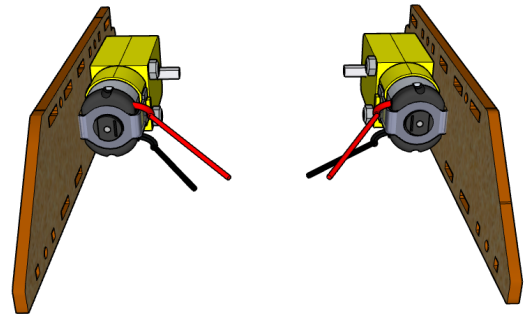
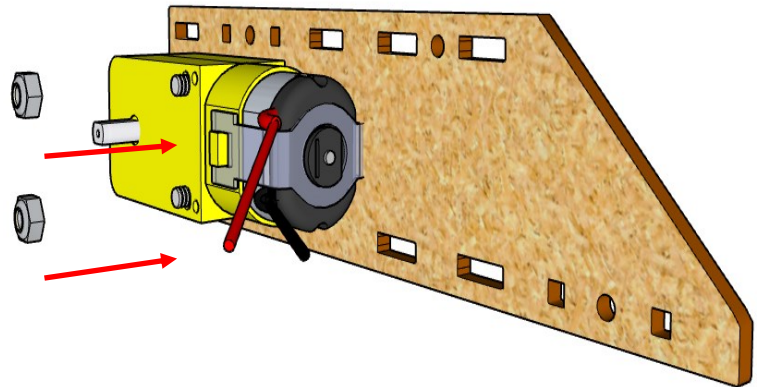

Nota: Asegúrese de que las terminales rojas de los motores estén hacia arriba

44

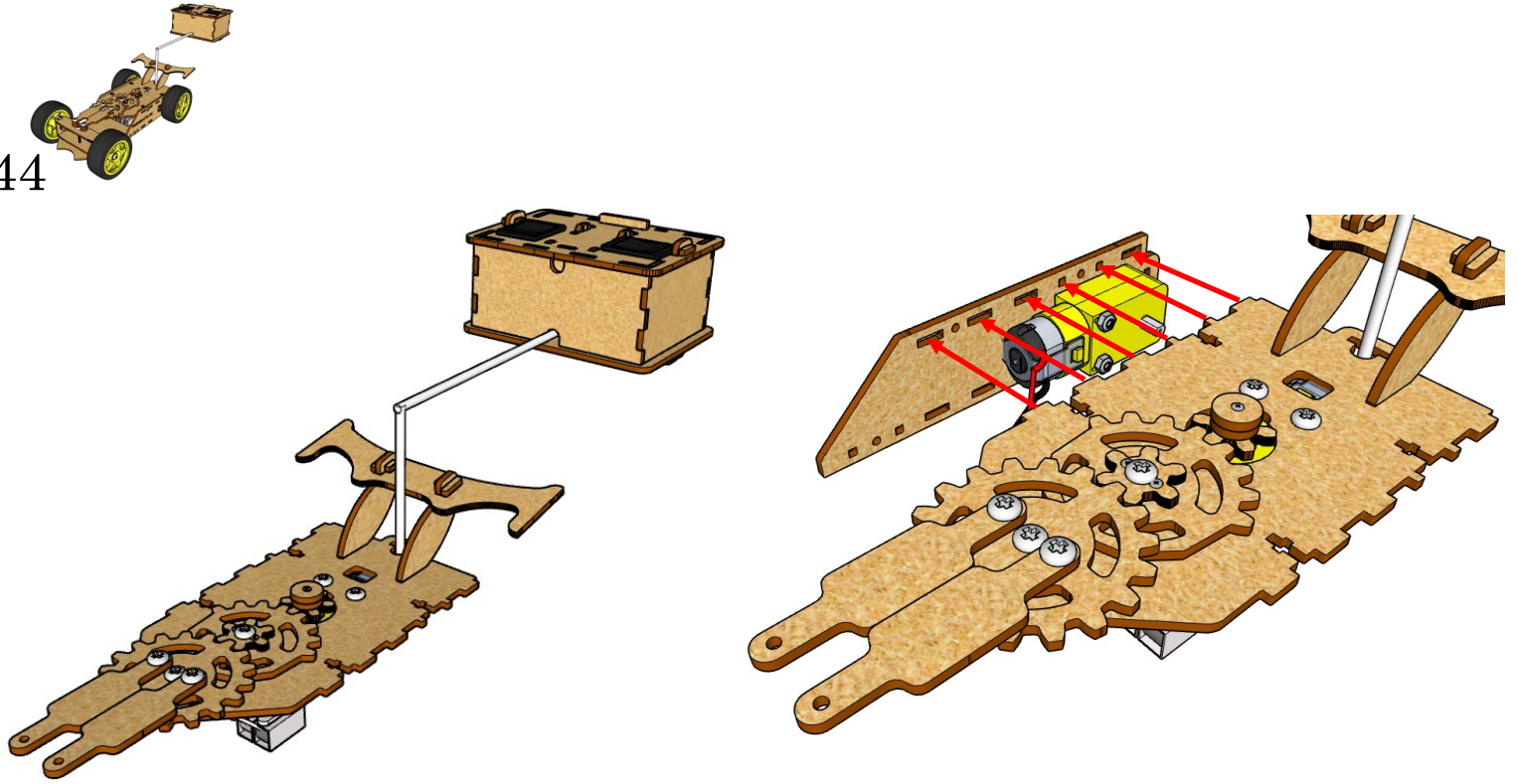

45

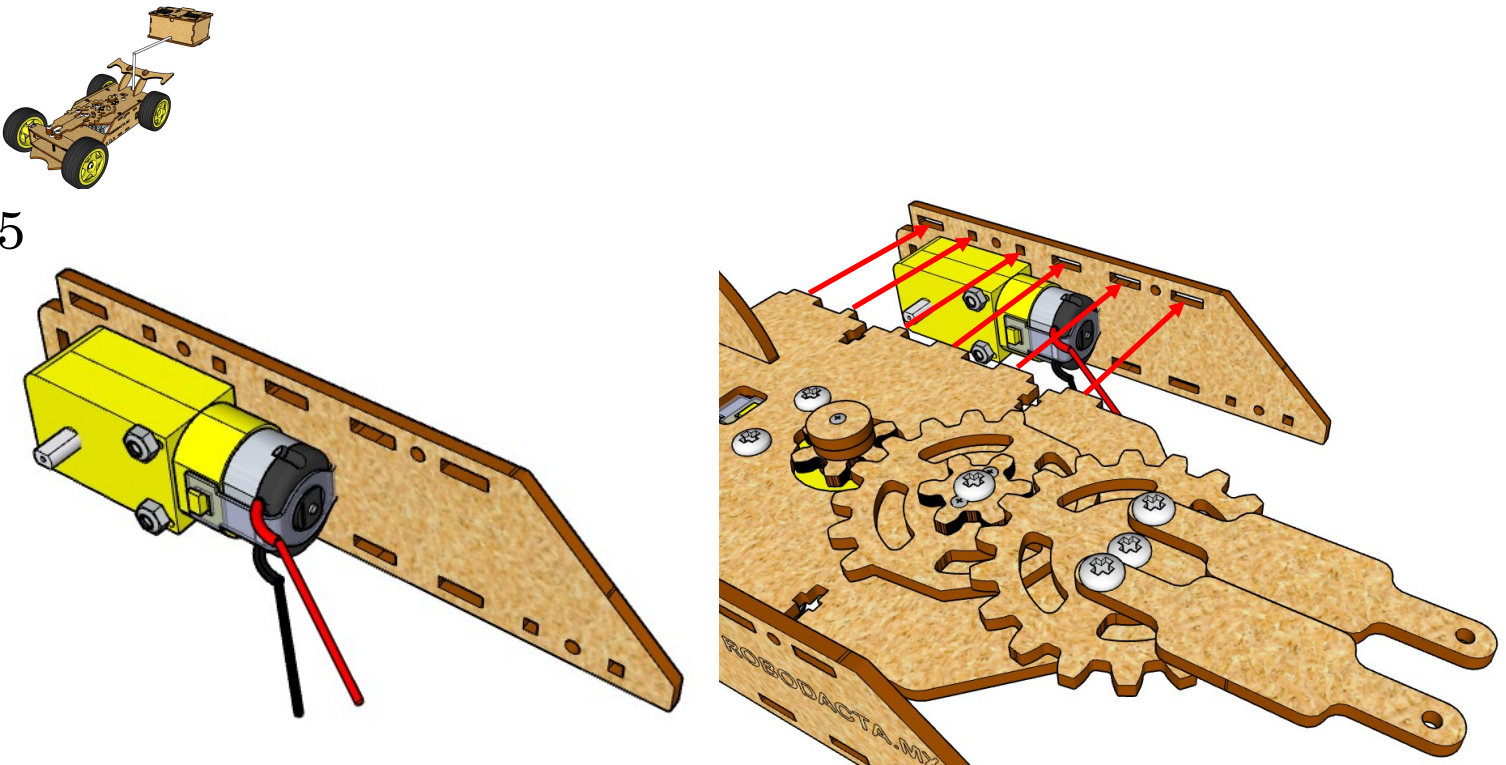

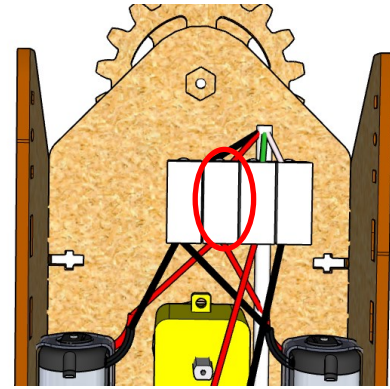
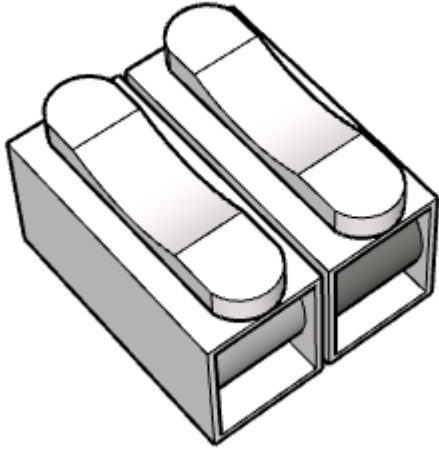
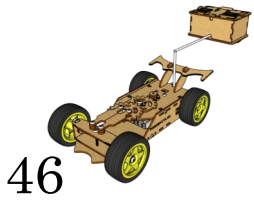

Nota: Conecta aquí las terminales rojas

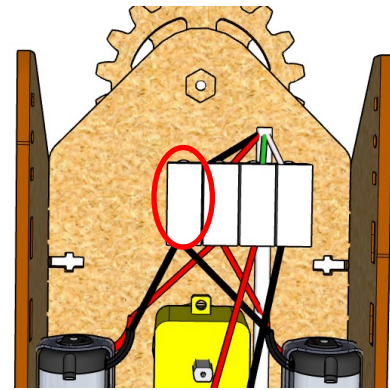

Nota: Conecta aquí las terminales negras

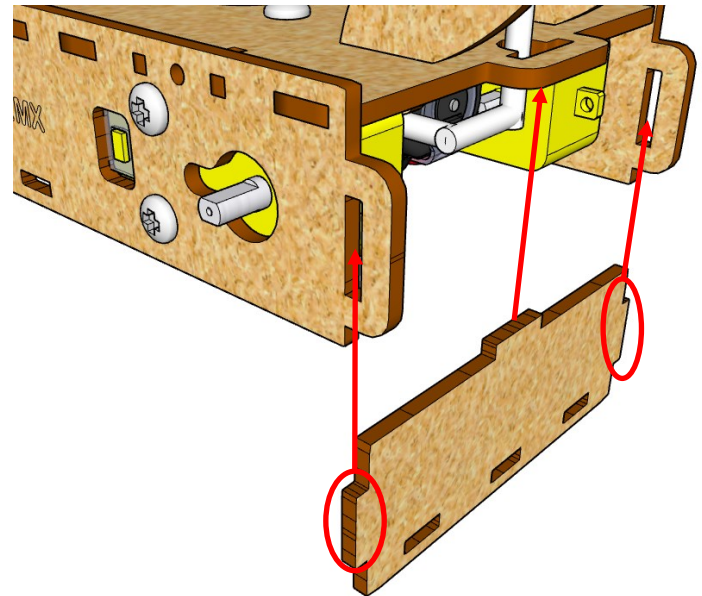
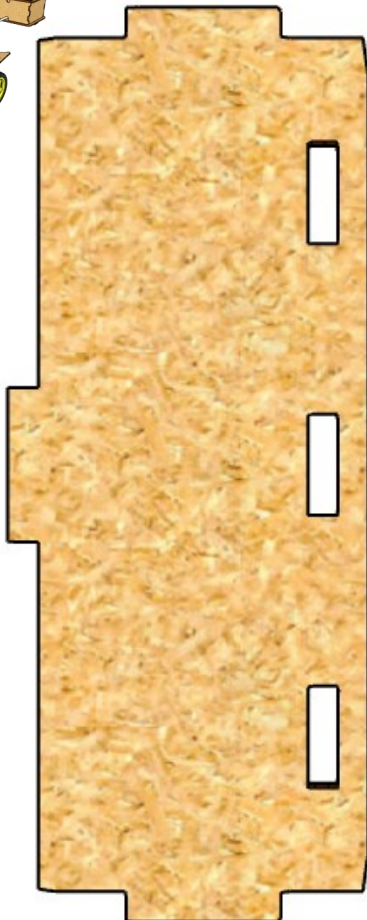
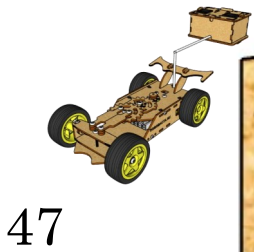

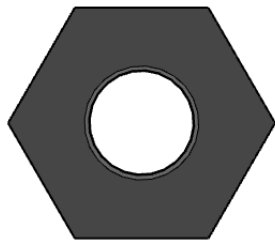
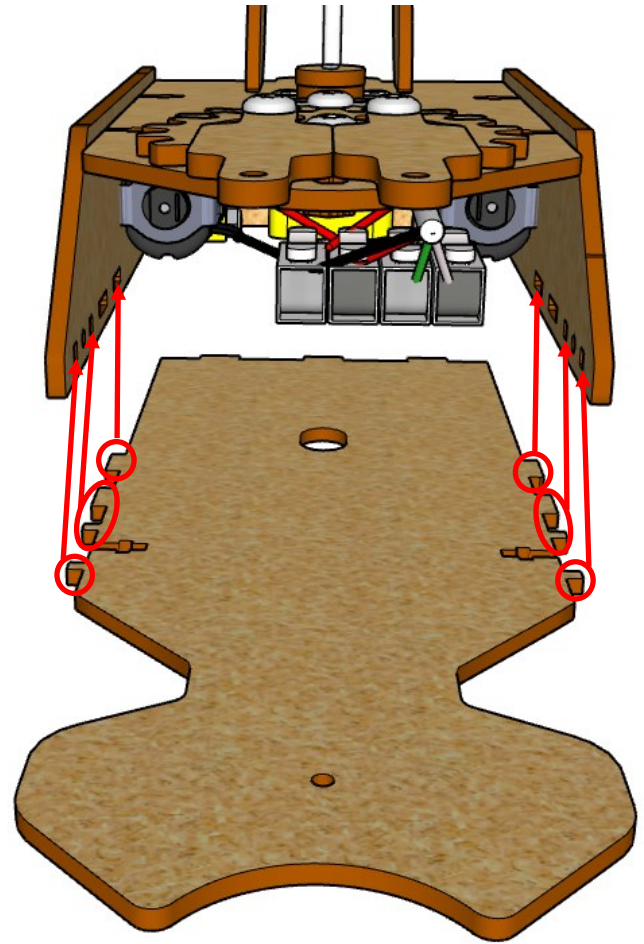
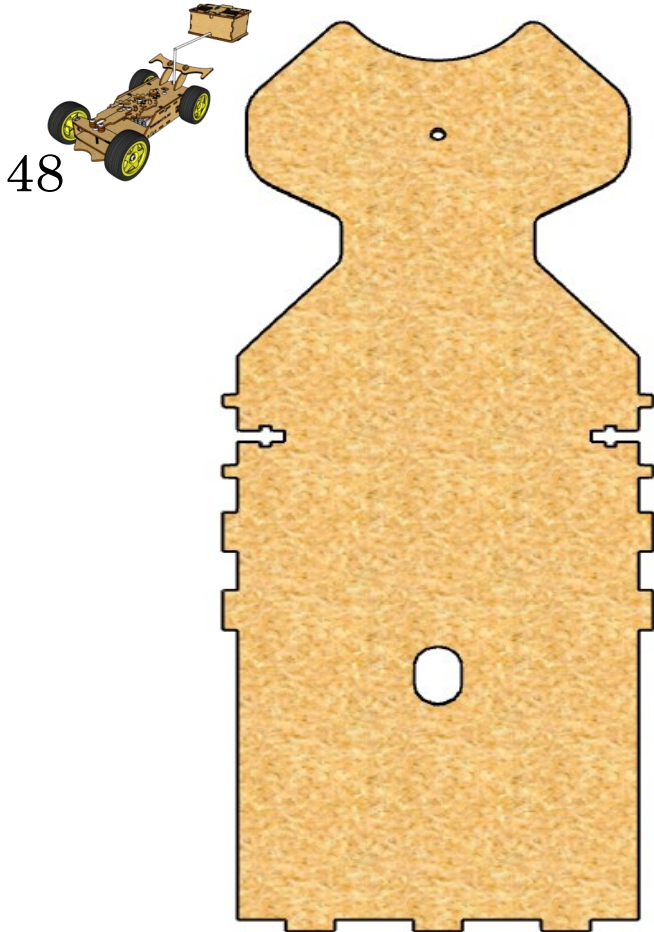

x2

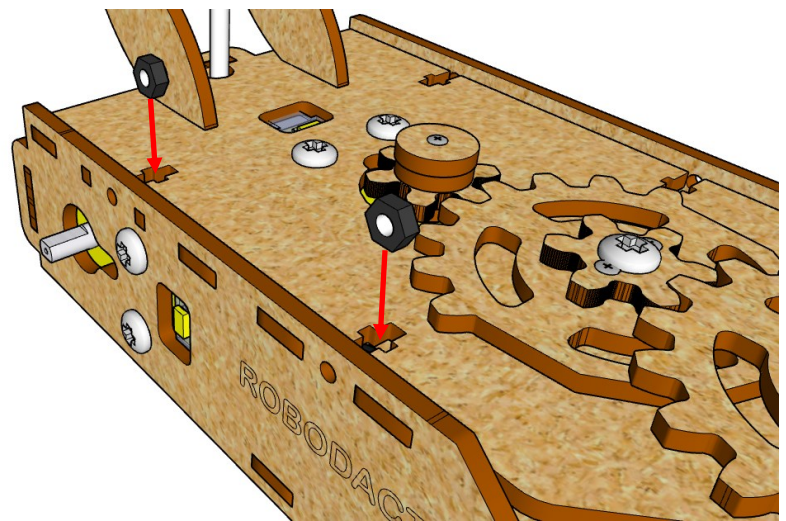

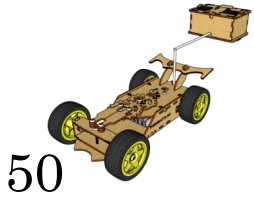

50

Tornillo de 1.4 cm

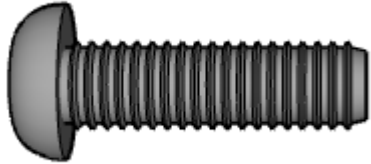

x2

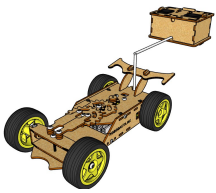
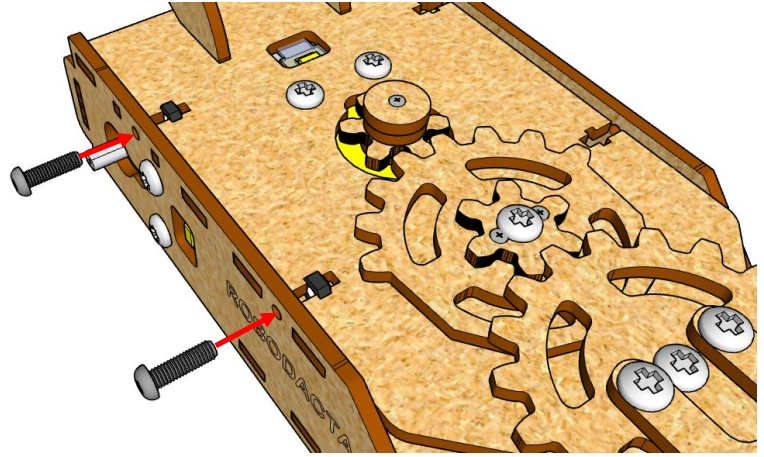

51

Tuerca metálica pequeña

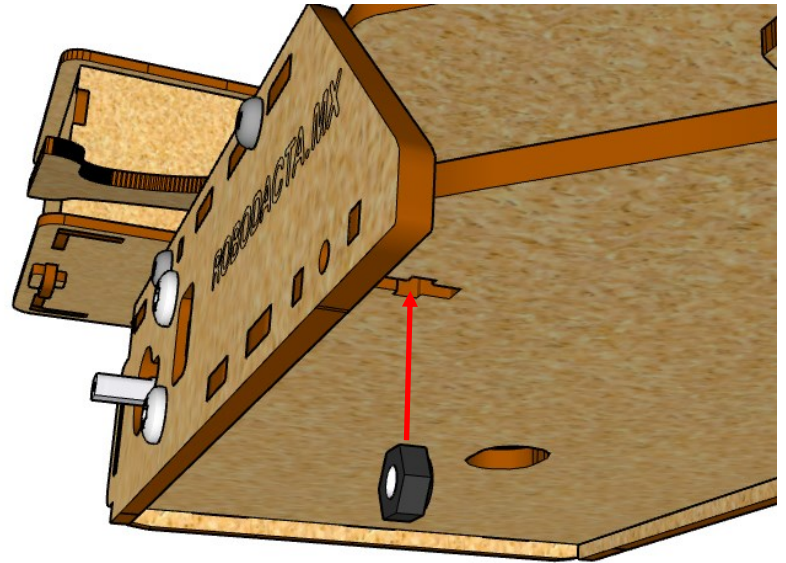
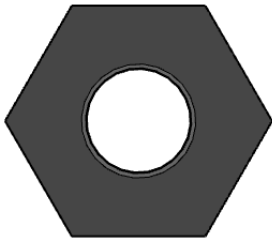

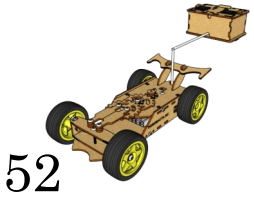

52

Tornillo de 1.4 cm

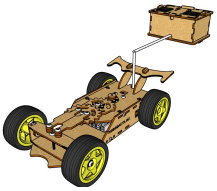
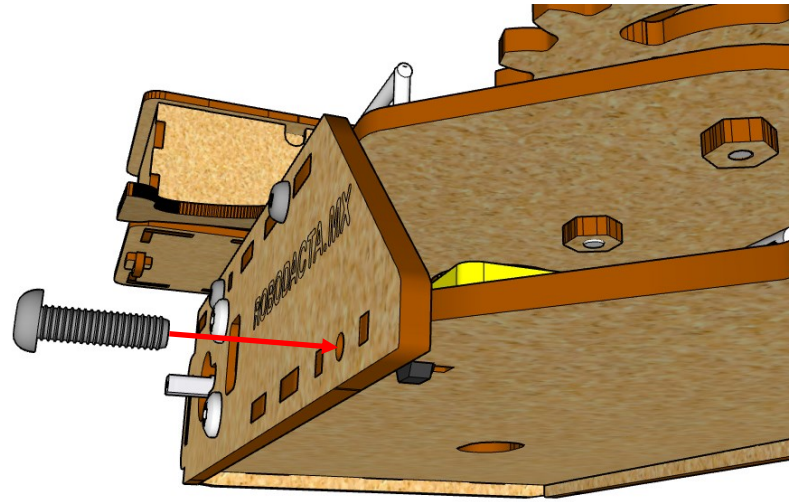
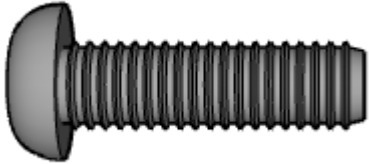

53

Tuerca metálica pequeña

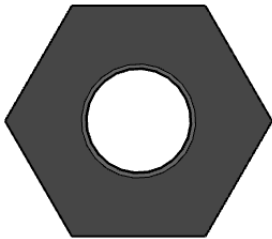

x2

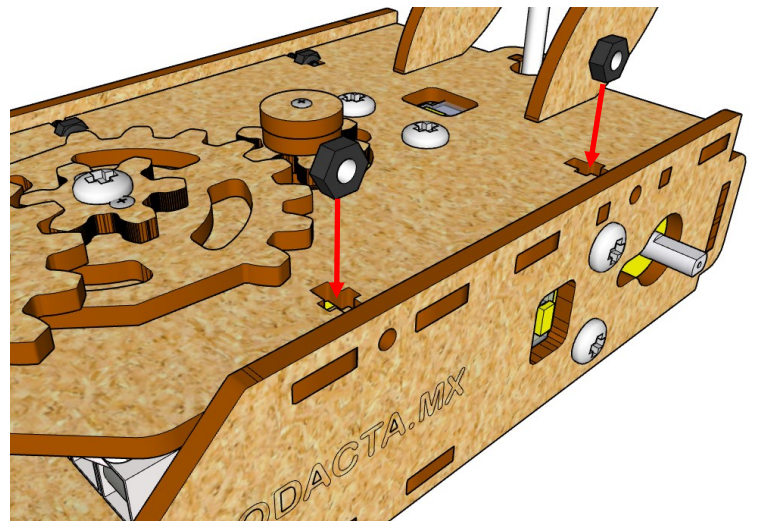

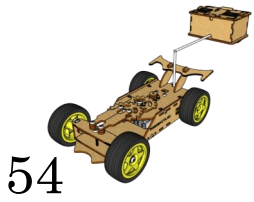

54

Tornillo de 1.4 cm

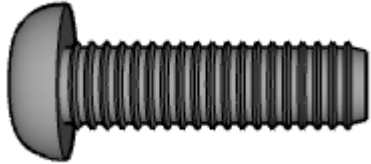

x2

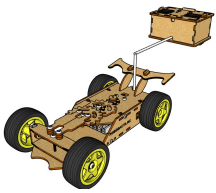
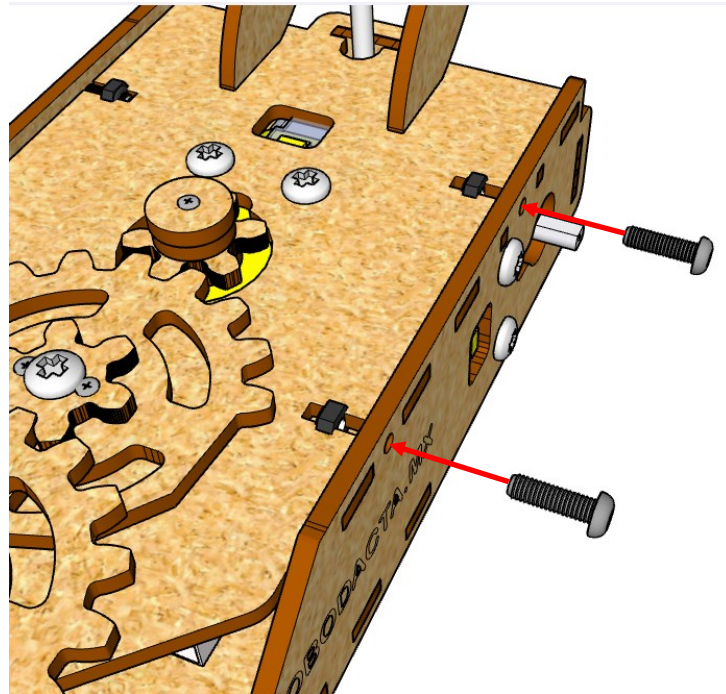

55

Tuerca metálica pequeña

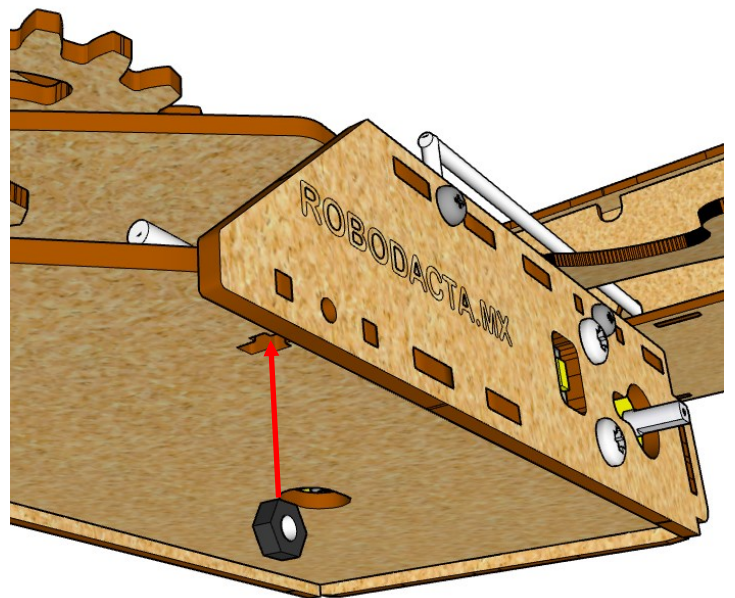
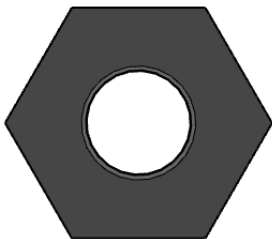

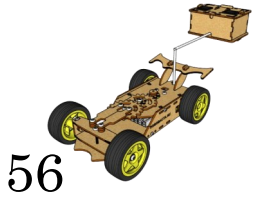

Tornillo de 1.4 cm

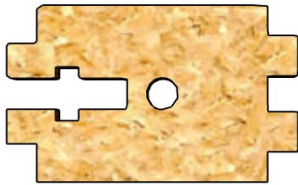
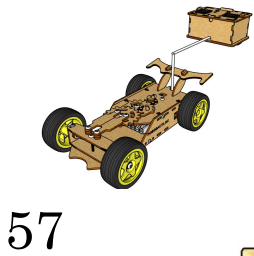
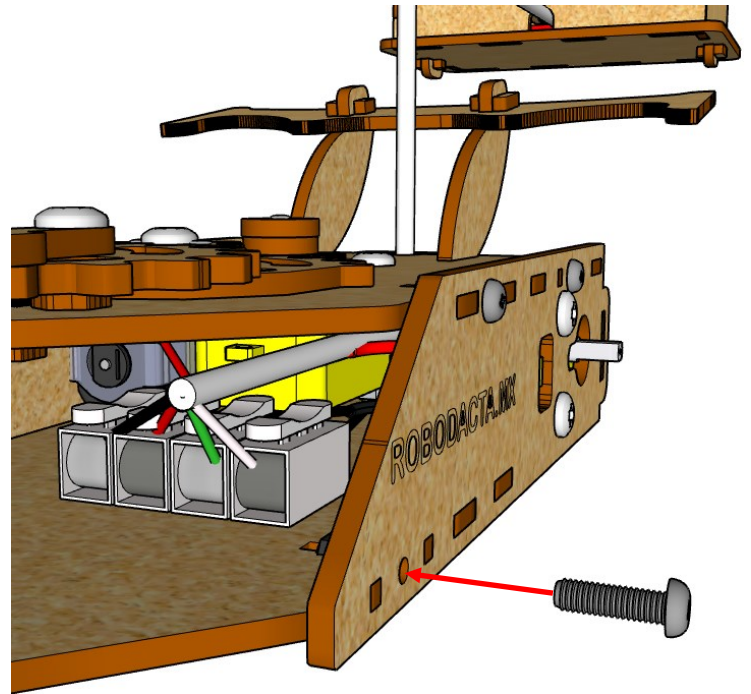
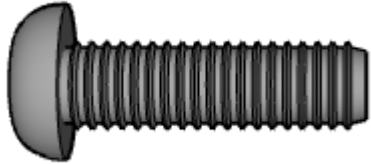

x2

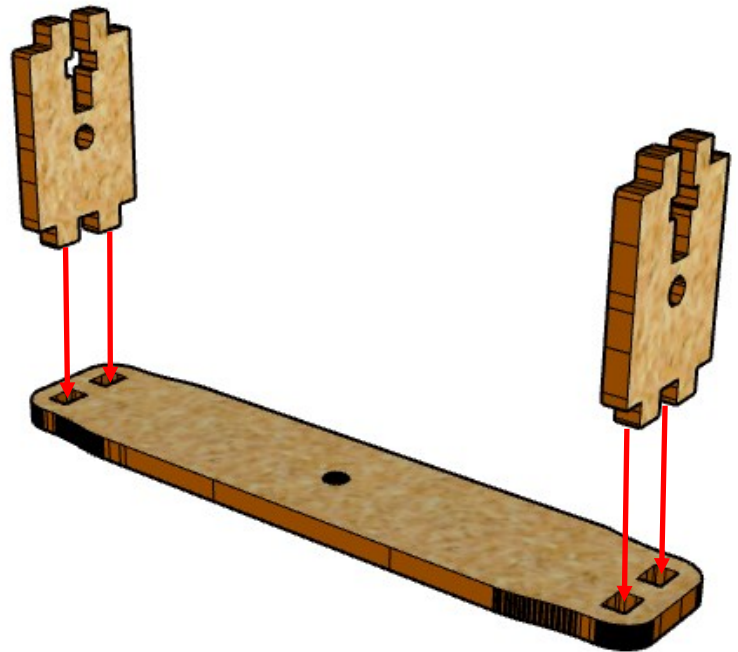

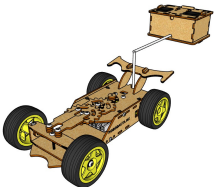
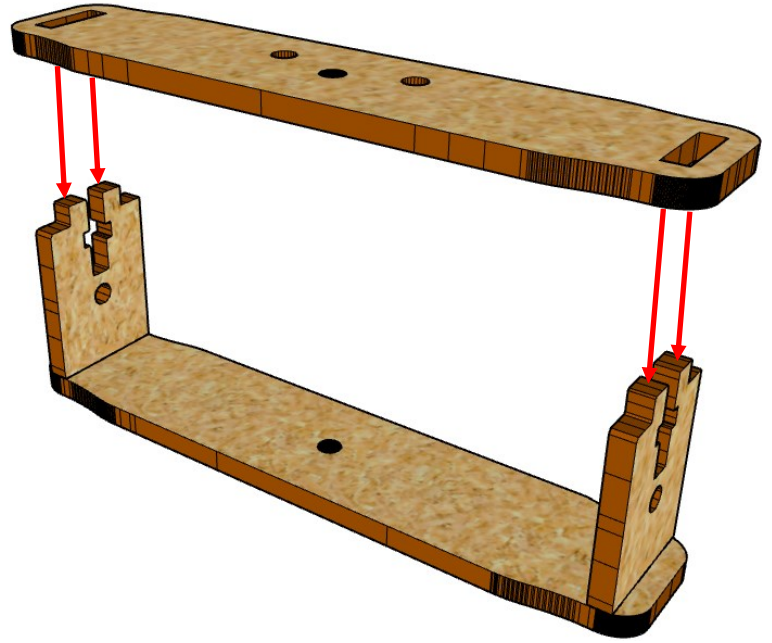
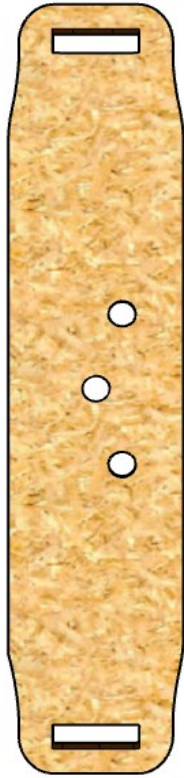
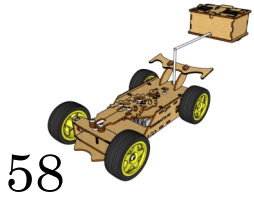

Tuerca metálica pequeña

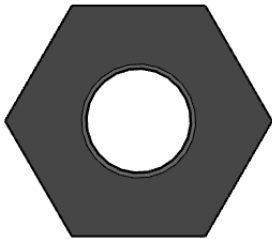



60

Tornillo de 1.4 cm

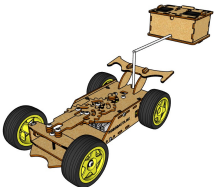
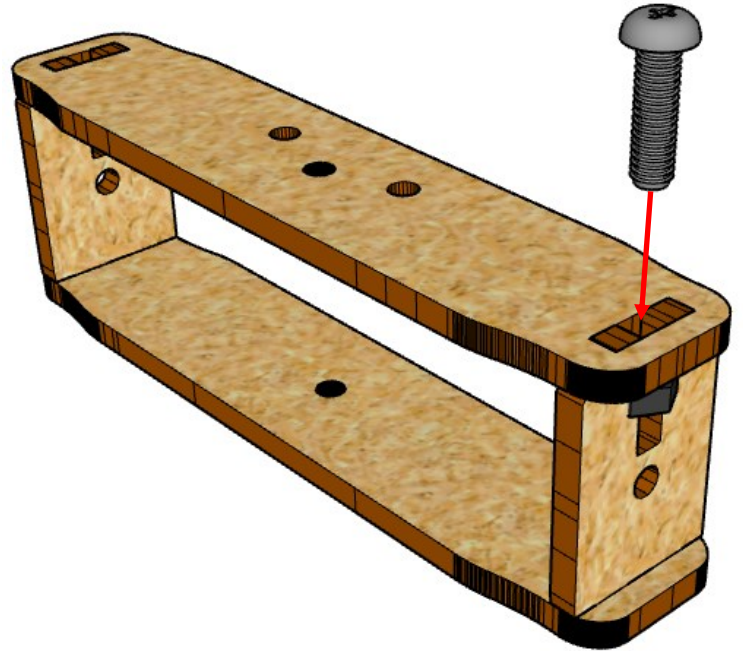

61

Tuerca metálica pequeña

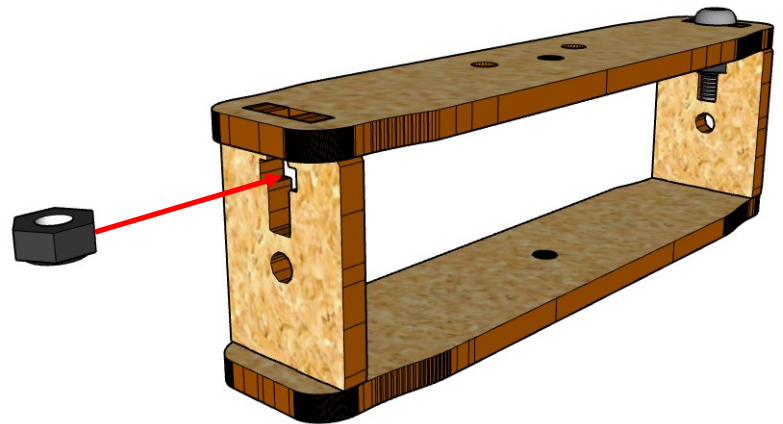
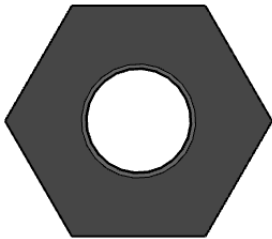

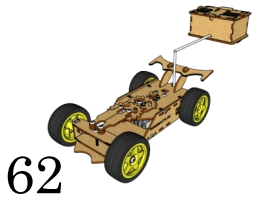

Tornillo de 1.4 cm

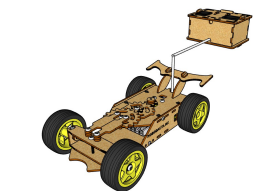
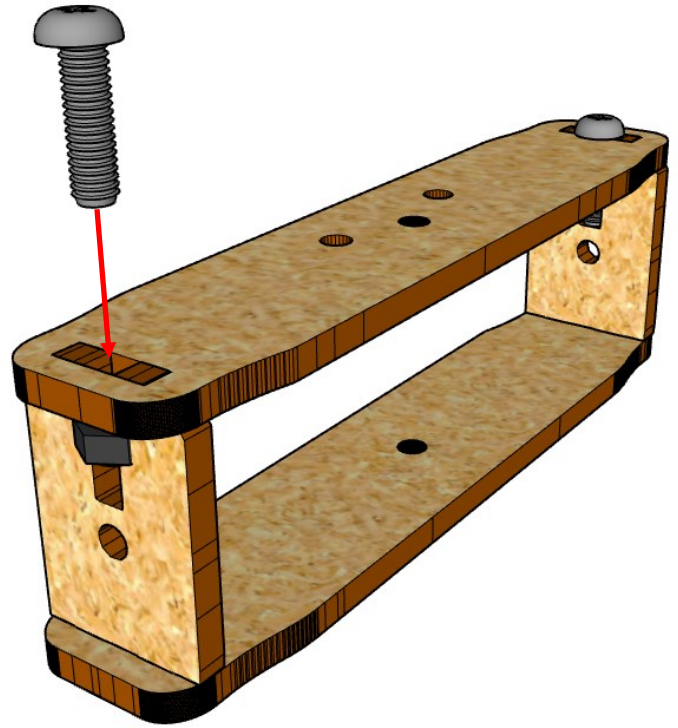
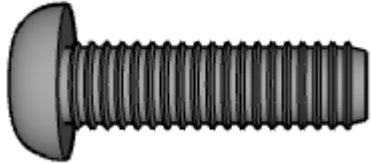

Buje grande



x4

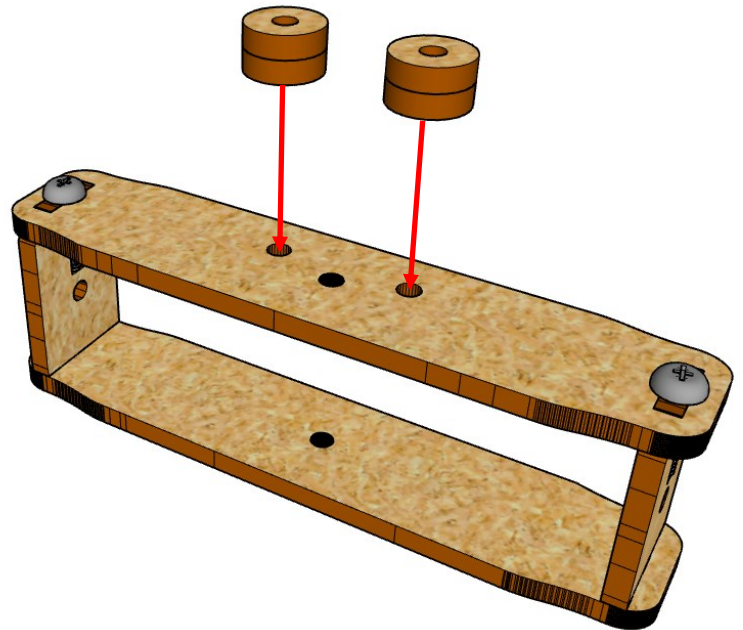

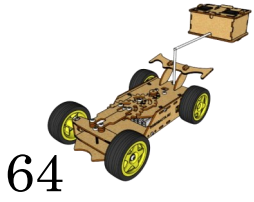

64

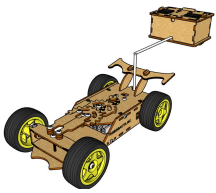
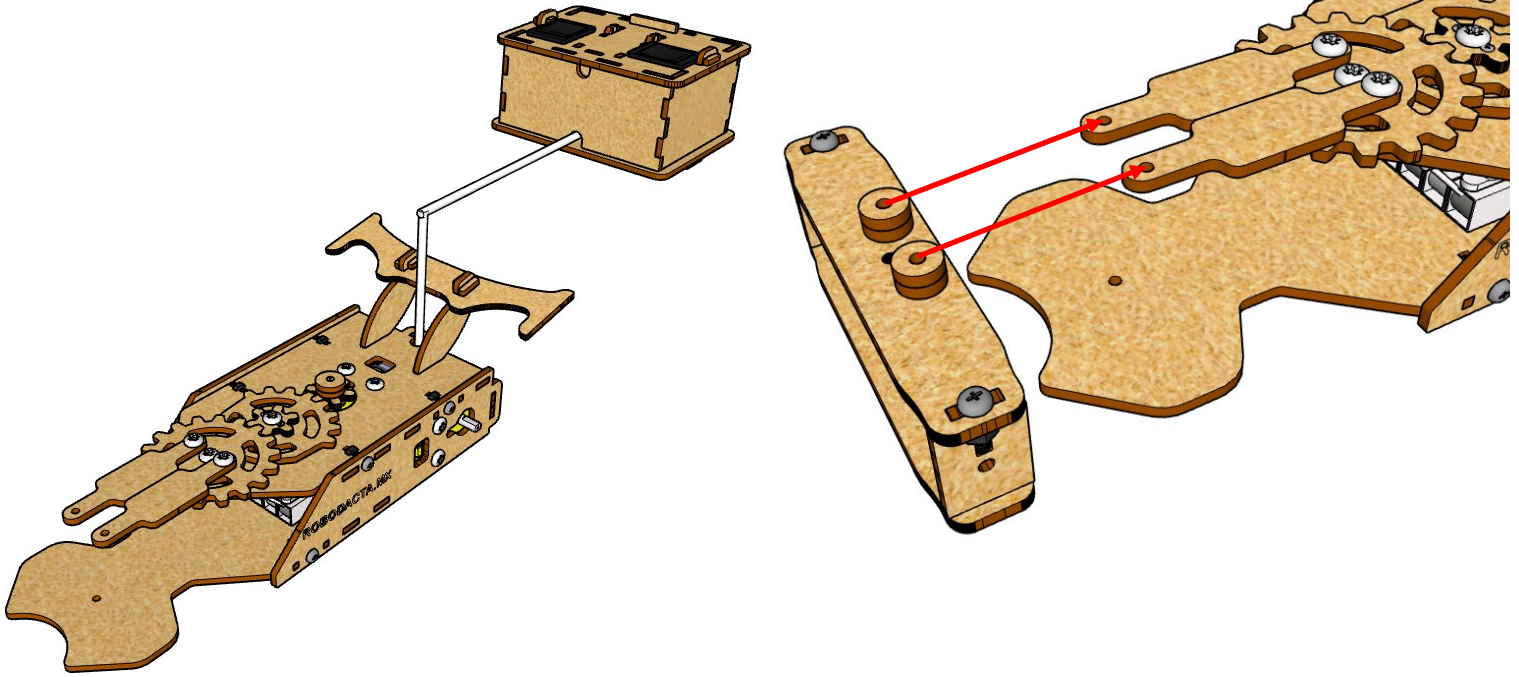

65

Tornillo de 2 cm

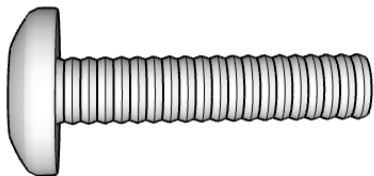

x2

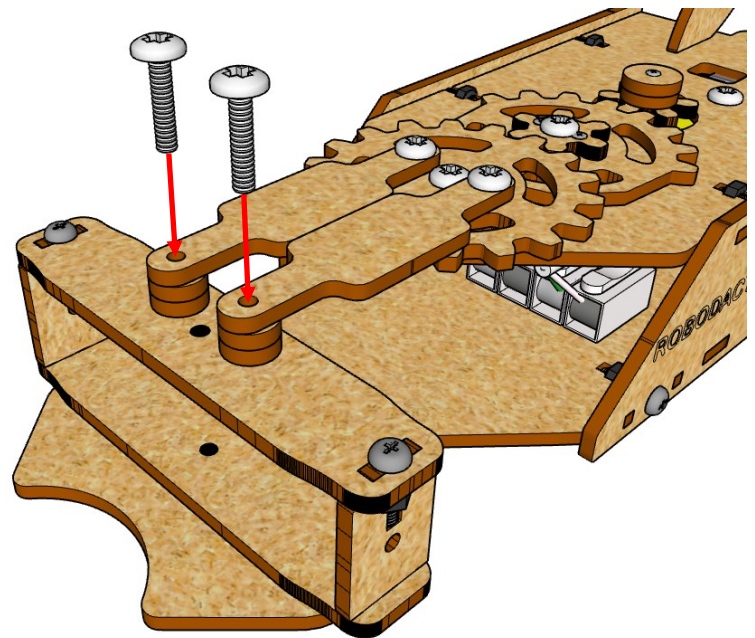

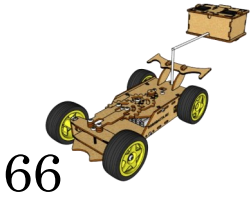

66

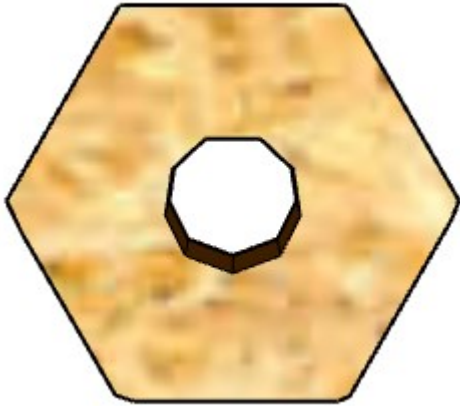

x2

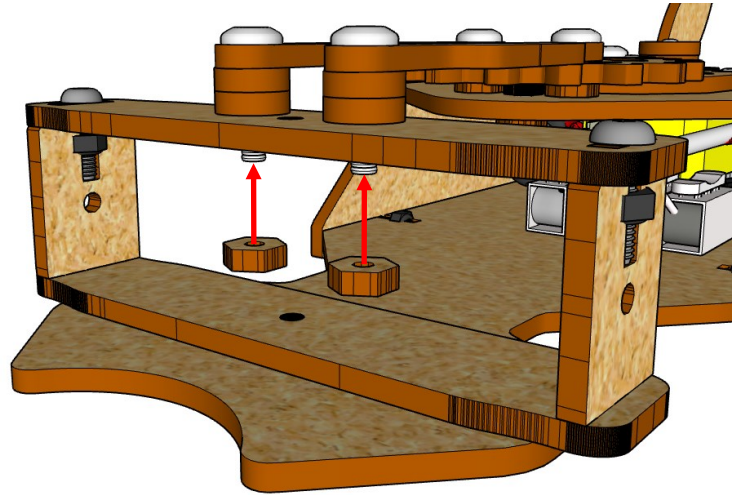

*Nota: al colocar las tuercas de MDF ajusta asta el tope y regresa 1/2 de vuelta.*

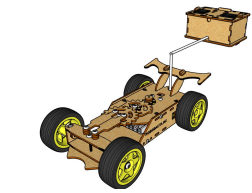

67

Tornillo de 3.9 cm

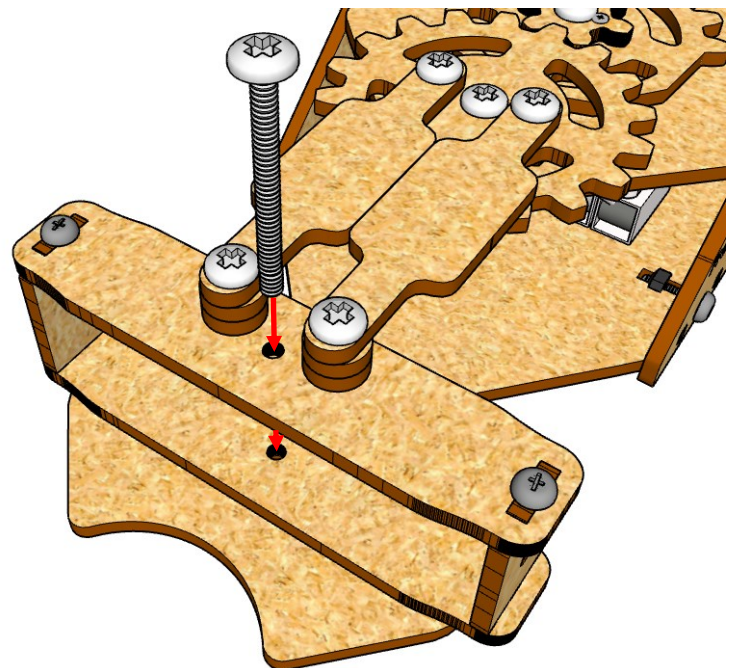
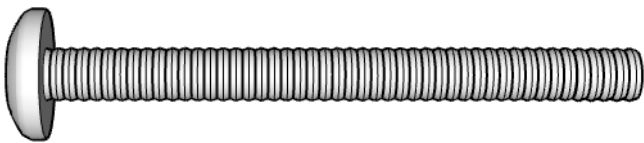

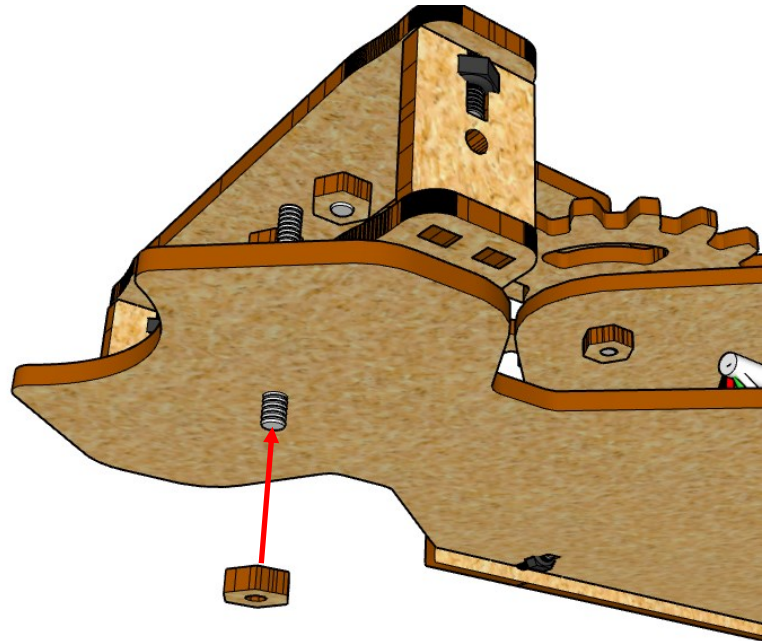
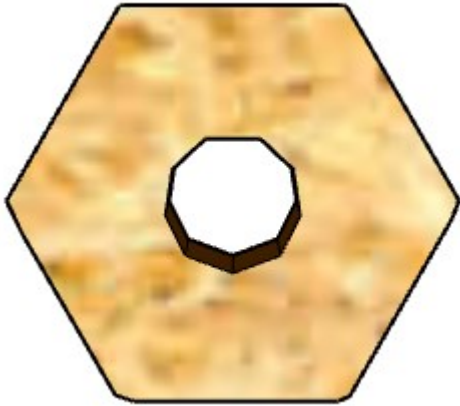
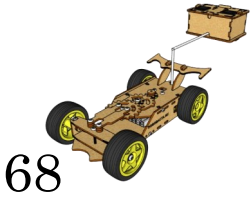

*Nota: al colocar la tuerca de MDF ajusta asta el tope y regresa 1/2 de vuelta.*

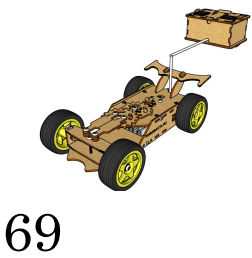

Tornillo de 3.9

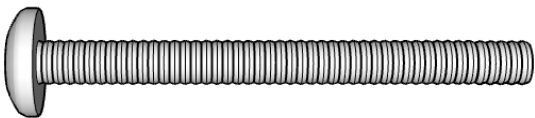

Buje grande

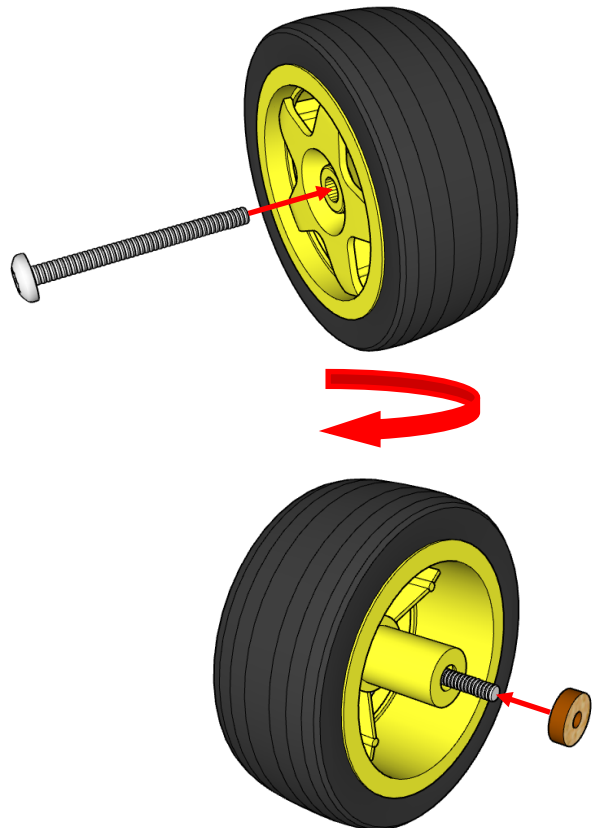
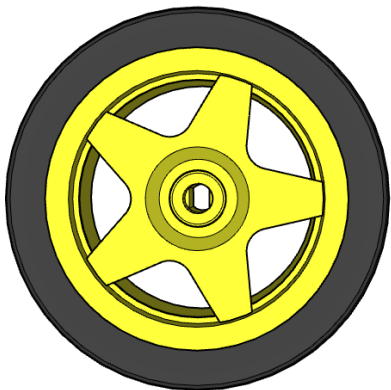

Nota: Realiza este paso en la otra rueda con orificio en el centro

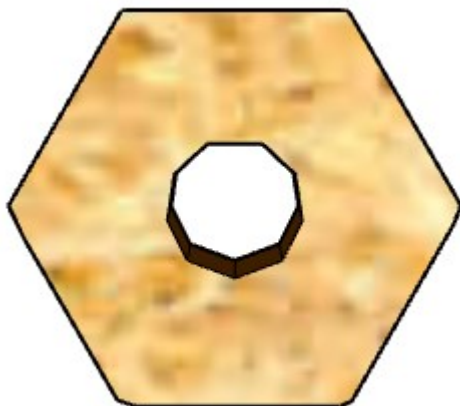
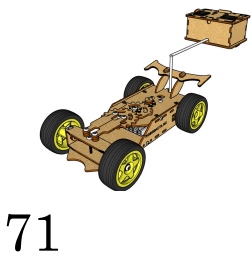
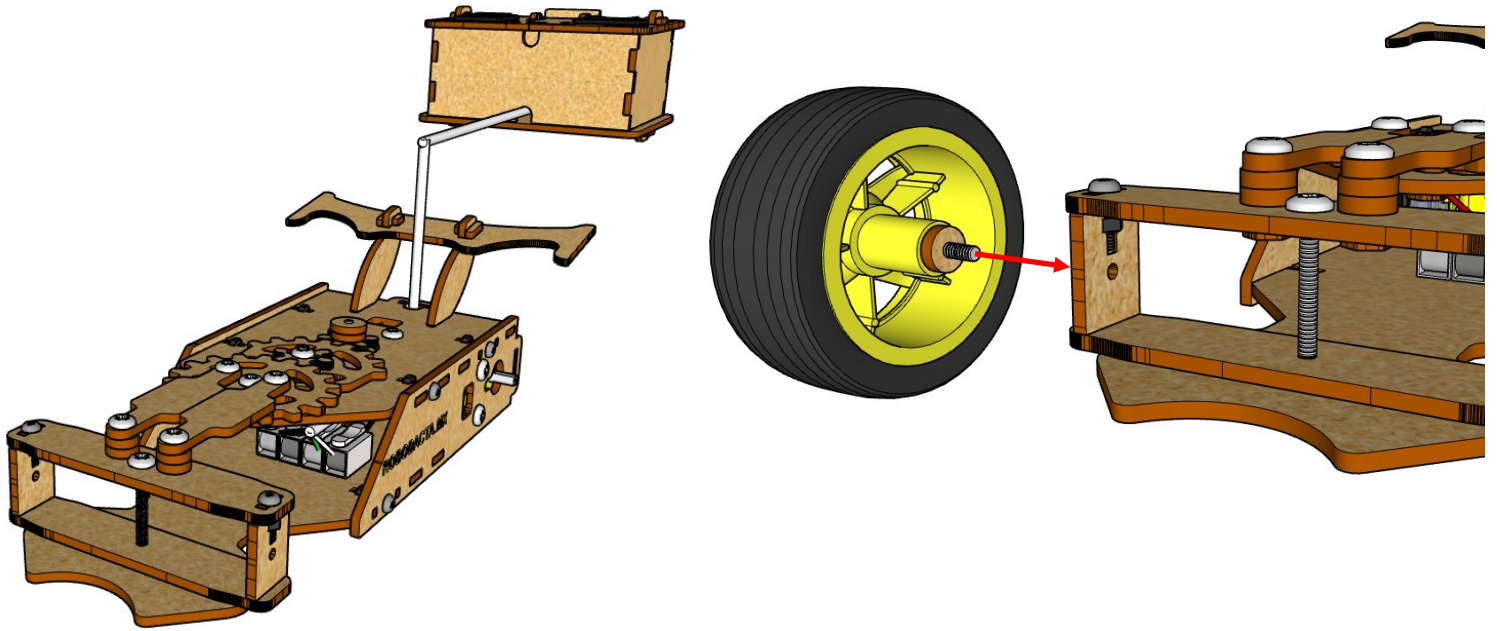
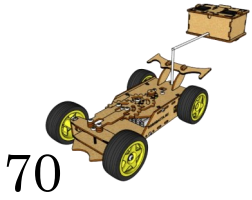

x2

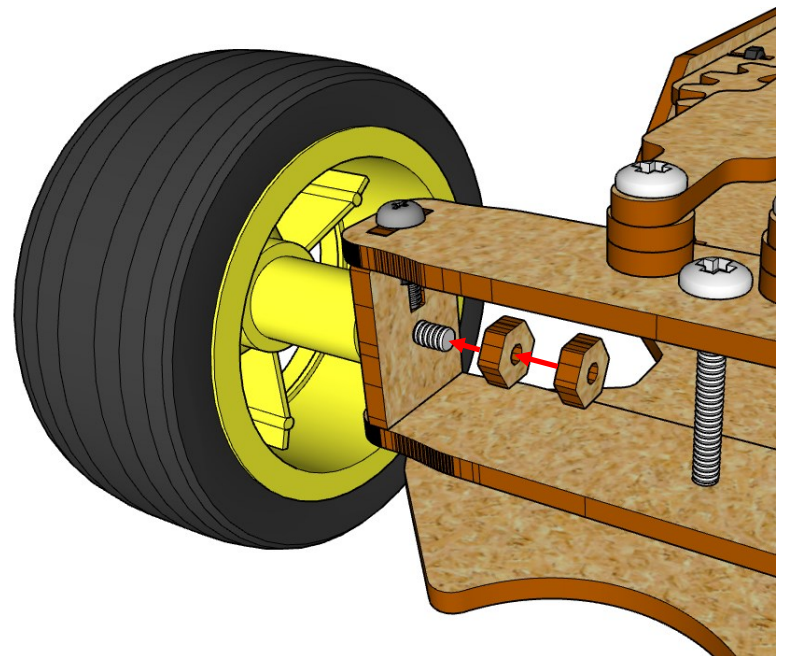

*Nota: al colocar las tuercas de MDF ajusta asta el tope y regresa 1/2 de vuelta.*

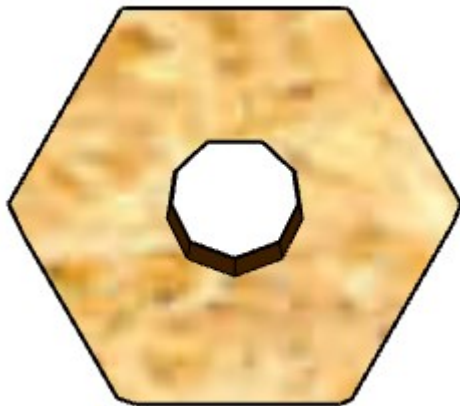
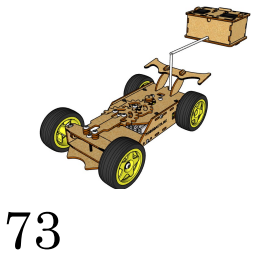
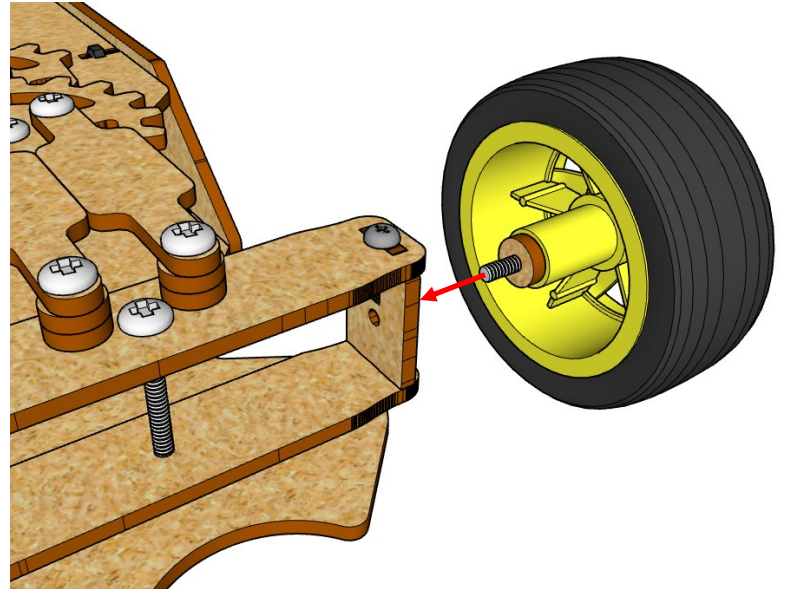
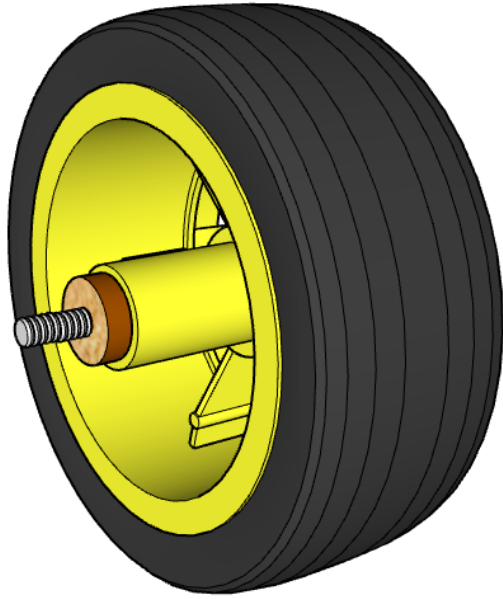
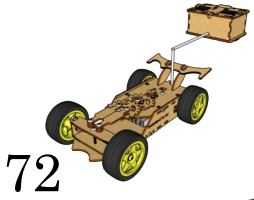

x2

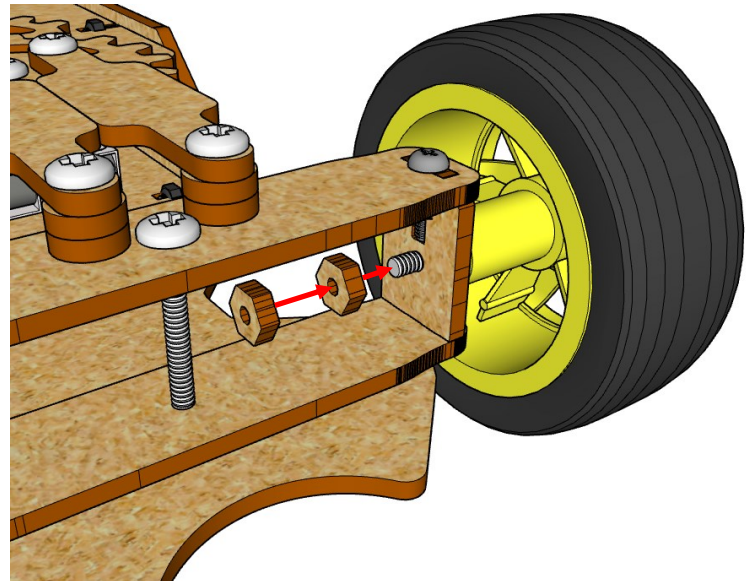

*Nota: al colocar las tuercas de MDF ajusta asta el tope y regresa 1/2 de vuelta.*

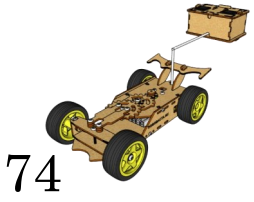

74

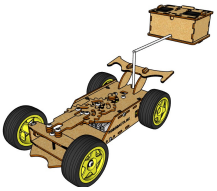
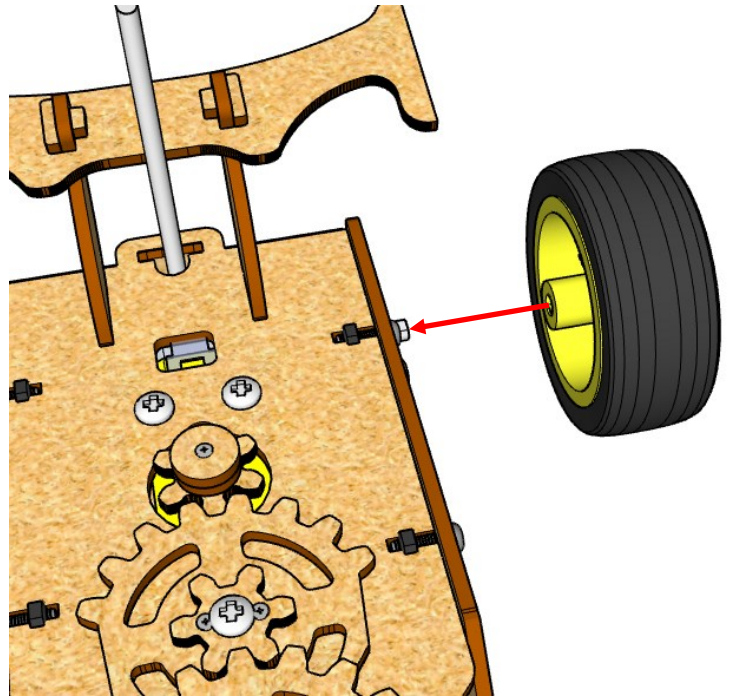
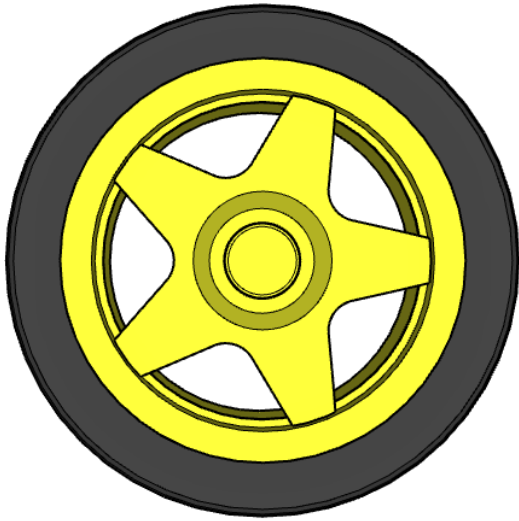

75

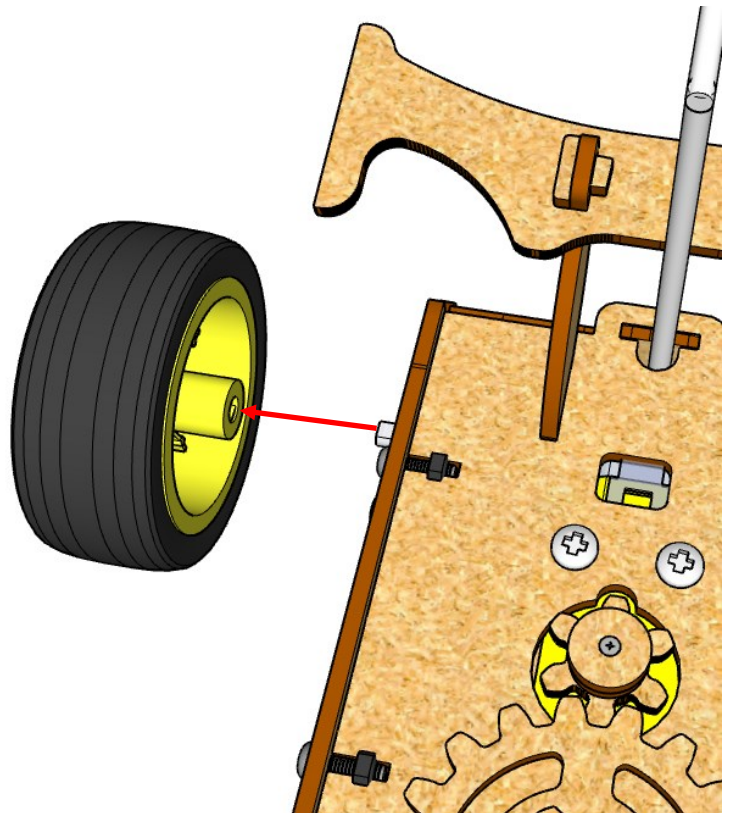
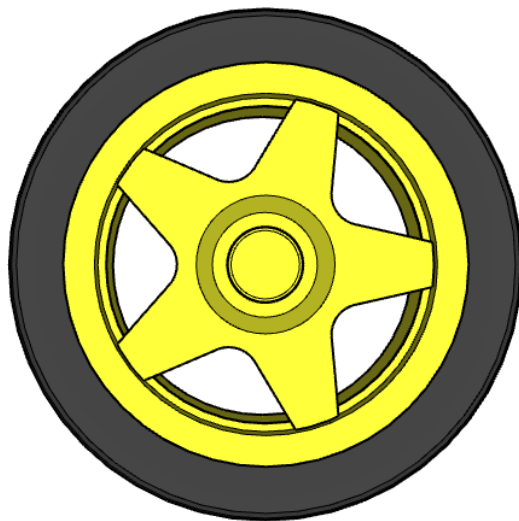

# Tornillería

Utiliza el siguiente esquema para comparar y conocer las medidas de los tornillos y tuercas que necesitas durante el ensamble. Solo basta con colocar encima el tornillo o tuerca hasta que coincida con alguna de las figuras. (Para corroborar correctamente las medidas de los tornillos imprime esta hoja)

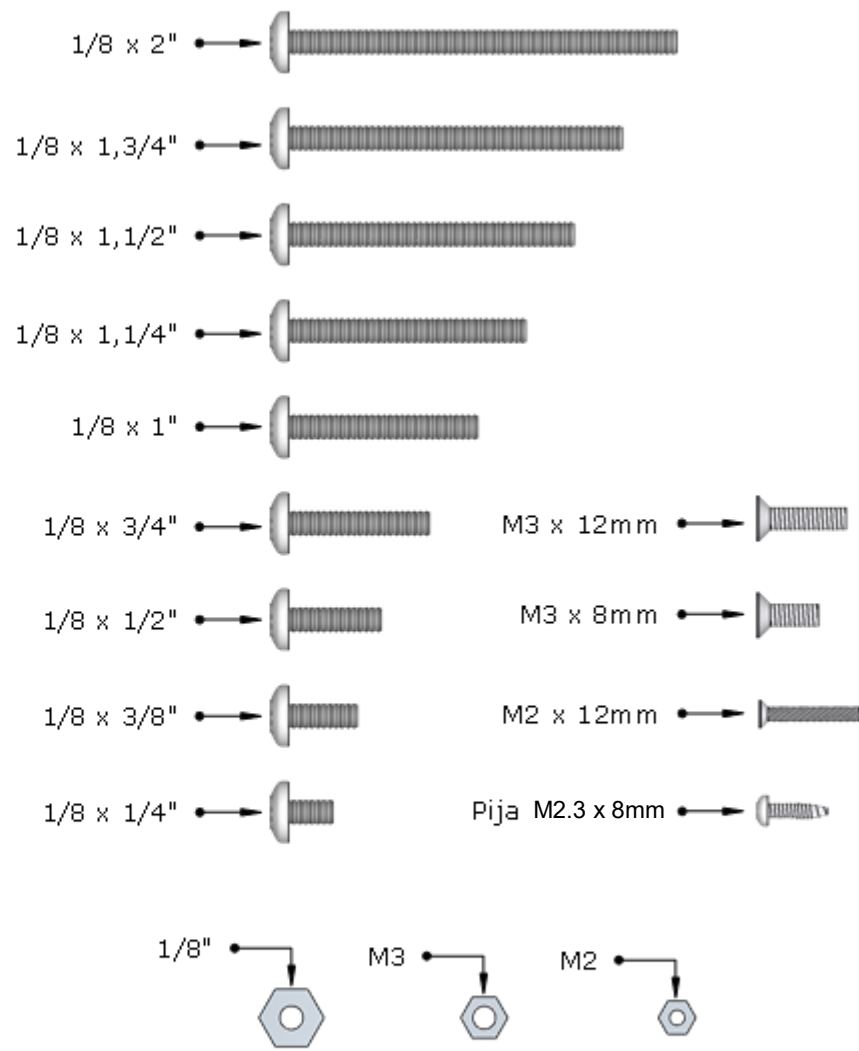

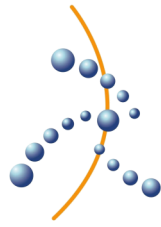

**robodacta**.mx  
robótica didáctica

No te olvides visitar nuestro sitio web y seguirnos en nuestras redes sociales donde encontrarás más contenido.

[www.robodacta.mx](http://www.robodacta.mx)



@Robodacta.RD



56 28 08 95 23



@robodacta.mx



RobodactaMx